

National Aeronautics and  
Space Administration

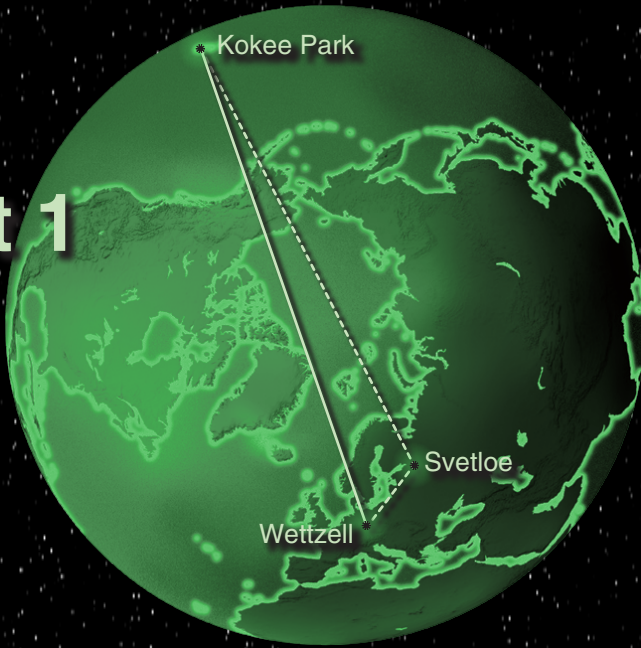

**Int 1**



International VLBI Service for  
Geodesy and Astrometry

# Annual Report 2008

**Int 2**

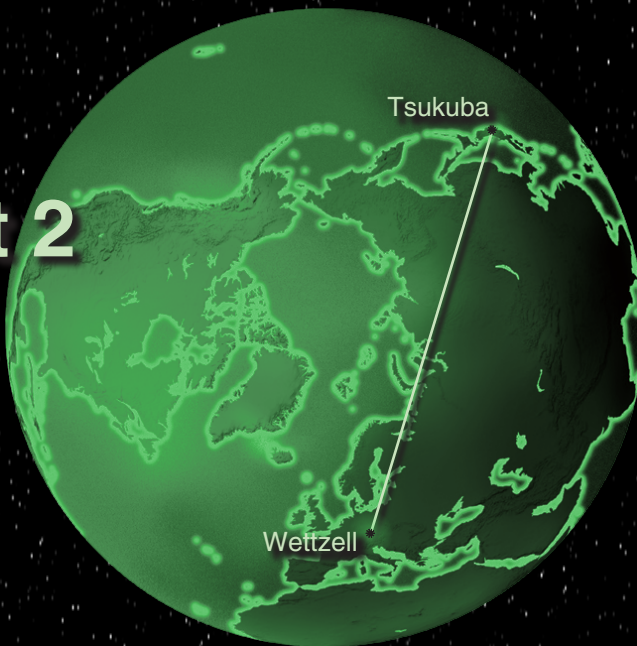

**Int 3**



Edited by  
D. Behrend and K.D. Baver

.....  
IVS Coordinating Center  
July 2009

NASA/TP-2009-214183

[www.nasa.gov](http://www.nasa.gov)

## The NASA STI Program Office ... in Profile

Since its founding, NASA has been dedicated to the advancement of aeronautics and space science. The NASA Scientific and Technical Information (STI) Program Office plays a key part in helping NASA maintain this important role.

The NASA STI Program Office is operated by Langley Research Center, the lead center for NASA's scientific and technical information. The NASA STI Program Office provides access to the NASA STI Database, the largest collection of aeronautical and space science STI in the world. The Program Office is also NASA's institutional mechanism for disseminating the results of its research and development activities. These results are published by NASA in the NASA STI Report Series, which includes the following report types:

- **TECHNICAL PUBLICATION.** Reports of completed research or a major significant phase of research that present the results of NASA programs and include extensive data or theoretical analysis. Includes compilations of significant scientific and technical data and information deemed to be of continuing reference value. NASA's counterpart of peer-reviewed formal professional papers but has less stringent limitations on manuscript length and extent of graphic presentations.
- **TECHNICAL MEMORANDUM.** Scientific and technical findings that are preliminary or of specialized interest, e.g., quick release reports, working papers, and bibliographies that contain minimal annotation. Does not contain extensive analysis.
- **CONTRACTOR REPORT.** Scientific and technical findings by NASA-sponsored contractors and grantees.

- **CONFERENCE PUBLICATION.** Collected papers from scientific and technical conferences, symposia, seminars, or other meetings sponsored or cosponsored by NASA.
- **SPECIAL PUBLICATION.** Scientific, technical, or historical information from NASA programs, projects, and mission, often concerned with subjects having substantial public interest.
- **TECHNICAL TRANSLATION.** English-language translations of foreign scientific and technical material pertinent to NASA's mission.

Specialized services that complement the STI Program Office's diverse offerings include creating custom thesauri, building customized databases, organizing and publishing research results . . . even providing videos.

For more information about the NASA STI Program Office, see the following:

- Access the NASA STI Program Home Page at <http://www.sti.nasa.gov/STI-homepage.html>
- E-mail your question via the Internet to [help@sti.nasa.gov](mailto:help@sti.nasa.gov)
- Fax your question to the NASA Access Help Desk at (443) 757-5803
- Telephone the NASA Access Help Desk at (443) 757-5802
- Write to:  
NASA Access Help Desk  
NASA Center for AeroSpace Information  
7115 Standard Drive  
Hanover, MD 21076-1320

### Available from:

NASA Center for AeroSpace Information  
7115 Standard Drive  
Hanover, MD 21076-1320

National Technical Information Service  
5285 Port Royal Road  
Springfield, VA 22161

Front cover: As part of the IVS observing program, daily 1-hour UT1 Intensive measurements are made five days a week (Monday through Friday, Int1) on the baseline Wettzell (Germany) to Kokee Park (Hawaii, USA); on weekends (Saturday and Sunday, Int2) on the baseline Wettzell to Tsukuba (Japan); and on Monday mornings (Int3) in the middle of the 36-hour gap between the Int1 and Int2 Intensive series on the network Wettzell, Ny-Alesund (Norway), and Tsukuba. In order to prepare Svetloe (Russia) as a possible backup station for Wettzell, Svetloe participates two times per month in the Int1 sessions.

NASA/TP—2009–214183

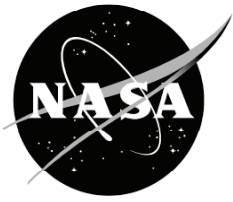

# International VLBI Service for Geodesy and Astrometry 2008 Annual Report

*Dirk Behrend*  
*NVI, Inc., Greenbelt, Maryland*

*Karen D. Baver*  
*NVI, Inc., Greenbelt, Maryland*

National Aeronautics and  
Space Administration

*Goddard Space Flight Center*  
*Greenbelt, MD 20771-0001*

---

**July 2009**

---

Available from:

NASA Center for Aerospace Information  
7121 Standard Drive  
Hanover, MD 21076-1320  
Price Code: A17

National Technical Information Service  
5285 Port Royal Road  
Springfield, VA 22161  
Price Code: A10

## Preface

This volume of reports is the 2008 Annual Report of the International VLBI Service for Geodesy and Astrometry (IVS). The individual reports were contributed by VLBI groups in the international geodetic and astrometric community who constitute the permanent components of IVS.

The IVS 2008 Annual Report documents the work of the IVS components for the calendar year 2008, our tenth year of existence. The reports describe changes, activities, and progress of the IVS. Many thanks to all IVS components who contributed to this Annual Report.

The contents of this Annual Report also appear on the IVS Web site at

<http://ivscc.gsfc.nasa.gov/publications/ar2008>

This book and the Web site are organized as follows:

- The first section contains general information about IVS, a map showing the location of the components, information about the Directing Board members, and the annual report of the IVS Chair.
- The second section contains two special reports. The first is a version of the Progress Report of the IVS VLBI2010 Committee titled “Design Aspects of the VLBI2010 System”. This report summarizes the progress made in developing the next generation VLBI system that was made up to the end of 2008. The second special report is about the upcoming VLBI site in New Zealand run by Auckland University of Technology. The site is expected to become an IVS Network Station in 2009.
- The next seven sections hold the reports from the Coordinators and the reports from the IVS Permanent Components: Network Stations, Operation Centers, Correlators, Data Centers, Analysis Centers, and Technology Development Centers.
- The next section contains a compilation of publications in the field of geodetic and astrometric VLBI during 2008.
- The last section includes reference information about IVS: the Terms of Reference, the lists of Member and Affiliated organizations, the IVS Associate Member list, a complete list of IVS components, the list of institutions that contributed to this report, and a list of acronyms.



# Table of Contents

Preface .....	iii
<b>About IVS .....</b>	<b>1</b>
IVS Organization .....	2
IVS Component Map .....	4
IVS Directing Board .....	6
IVS Chair's Report .....	8
<b>Special Reports .....</b>	<b>11</b>
Design Aspects of the VLBI2010 System .....	13
New Zealand 12-m VLBI Station for Geodesy and Astronomy .....	68
<b>IVS Coordination .....</b>	<b>75</b>
Coordinating Center Report .....	77
Analysis Coordinator Report .....	80
Network Coordinator Report .....	83
IVS Technology Coordinator Report .....	89
<b>Network Stations .....</b>	<b>93</b>
Badary Radio Astronomical Observatory .....	95
Fortaleza Station Report for 2008 .....	99
Goddard Geophysical and Astronomical Observatory .....	103
Hartebeesthoek Radio Astronomy Observatory (HartRAO) .....	107
Hobart, Mt. Pleasant, Station Report for 2008 .....	111
Kashima 34-m Radio Telescope .....	114
Kashima and Koganei 11-m VLBI Stations .....	118
Kokee Park Geophysical Observatory .....	122
Matera CGS VLBI Station .....	126
The Medicina Station Status Report .....	130
VERA Geodetic Activities .....	132
Noto Station Status Report .....	136
Ny-Ålesund 20-Meter Antenna .....	139
German Antarctic Receiving Station (GARS) O'Higgins .....	142
Onsala Space Observatory – IVS Network Station .....	146
Sheshan VLBI Station Report for 2008 .....	150
Simeiz VLBI Station - H-maser and Mark 5B+ Upgrade .....	154
Svetloe Radio Astronomical Observatory .....	158
JARE Syowa Station 11-m Antenna, Antarctica .....	161
Geodetic Observatory TIGO in Concepción .....	165
Tsukuba 32-m VLBI Station .....	169
Nanshan VLBI Station Report for 2008 .....	173
Westford Antenna .....	176
Fundamentalstation Wettzell - 20m Radiotelescope .....	180
Instituto Geográfico Nacional of Spain .....	184
Zelenchukskaya Radio Astronomical Observatory .....	188

<b>Operation Centers</b> .....	<b>191</b>
The Bonn Geodetic VLBI Operation Center .....	193
CORE Operation Center Report .....	195
NEOS Operation Center .....	198
<b>Correlators</b> .....	<b>199</b>
The Bonn Astro/Geo Mark IV Correlator .....	201
Haystack Observatory VLBI Correlator .....	205
IAA Correlator Center .....	209
VLBI Correlators in Kashima .....	212
Tsukuba VLBI Correlator .....	216
Washington Correlator .....	220
<b>Data Centers</b> .....	<b>223</b>
BKG Data Center .....	225
CDDIS Data Center Summary for the IVS 2008 Annual Report .....	227
Italy INAF Data Center Report .....	230
Data Center at NICT .....	232
Paris Observatory (OPAR) Data Center .....	236
<b>Analysis Centers</b> .....	<b>239</b>
Analysis Center of Saint Petersburg University .....	241
Geoscience Australia Analysis Center .....	243
Bordeaux Observatory Analysis Center Report .....	246
BKG/DGFI Combination Center Annual Report 2008 .....	250
Matera CGS VLBI Analysis Center .....	253
DGFI Analysis Center Annual Report 2008 .....	255
FFI Analysis Center .....	259
The BKG/IGGB VLBI Analysis Center .....	261
GSFC VLBI Analysis Center .....	265
IAA VLBI Analysis Center Report 2008 .....	269
Vienna IGG Special Analysis Center Annual Report 2008 .....	273
Italy INAF Analysis Center Report .....	277
JPL VLBI Analysis Center Report for 2008 .....	279
KASI Combination Center Report .....	283
IVS Analysis Center at Main Astronomical Observatory of National Academy of Sciences of Ukraine	285
Analysis Center at National Institute of Information and Communications Technology .....	287
Paris Observatory Analysis Center OPAR: Report on Activities, January - December 2008 .....	291
Onsala Space Observatory – IVS Analysis Center .....	295
Pulkovo IVS Analysis Center (PUL) 2008 Report .....	299
SHAO Analysis Center 2008 Annual Report .....	302
U.S. Naval Observatory VLBI Analysis Center .....	305
USNO Analysis Center for Source Structure Report .....	309
<b>Technology Development Centers</b> .....	<b>313</b>
Canadian VLBI Technology Development Center .....	315
FFI Technology Development Center - Software Development .....	317
GSFC Technology Development Center Report .....	318
Haystack Observatory Technology Development Center .....	321
Technology Development Center at NICT .....	325
Onsala Space Observatory – IVS Technology Development Center .....	329



**Bibliography** ..... **333**  
Bibliography ..... 335

**IVS Information** ..... **353**  
IVS Terms of Reference ..... 355  
IVS Member Organizations ..... 365  
IVS Affiliated Organizations ..... 366  
IVS Associate Members ..... 367  
IVS Permanent Components ..... 378  
Addresses of Institutions of Authors Contributing to this Report ..... 382  
List of Acronyms ..... 389





**About IVS**

**About IVS**

# IVS Organization

## Objectives

IVS is an international collaboration of organizations which operate or support Very Long Baseline Interferometry (VLBI) components. The goals are:

1. To provide a service to support geodetic,
2. geophysical and astrometric research and operational activities.
3. To promote research and development activities in all aspects of the geodetic and astrometric VLBI technique.
4. To interact with the community of users of VLBI products and to integrate VLBI into a global Earth observing system.

## The IVS

- Interacts closely with the IERS, which is tasked by IAU and IUGG with maintaining the international celestial and terrestrial reference frames (ICRF and ITRF),
- coordinates VLBI observing programs,
- sets performance standards for the observing stations,
- establishes conventions for data formats and products,
- issues recommendations for analysis software,
- sets standards for analysis documentation,
- institutes appropriate product delivery methods in order to insure suitable product quality and timeliness.

## Realization And Status Of IVS

### IVS consists of

- 27 Network Stations, acquiring high performance VLBI data,
- 3 Operation Centers, coordinating the activities of a network of Network Stations,
- 6 Correlators, processing the acquired data, providing feedback to the stations and providing processed data to analysts,
- 6 Data Centers, distributing products to users, providing storage and archiving functions,
- 25 Analysis Centers, analyzing the data and producing the results and products,
- 7 Technology Development Centers, developing new VLBI technology,
- 1 Coordinating Center, coordinating daily and long term activities.

### Altogether

- 75 Permanent Components, representing 39 institutions in 18 countries,
- ~280 Associate Members.

### In addition the IVS has:

- Directing Board, determining policies, standards and goals; the board is composed of 16 members (elected and ex officio), including
- Coordinators for the network, analysis and technology.

## ORGANIZATION OF INTERNATIONAL VLBI SERVICE

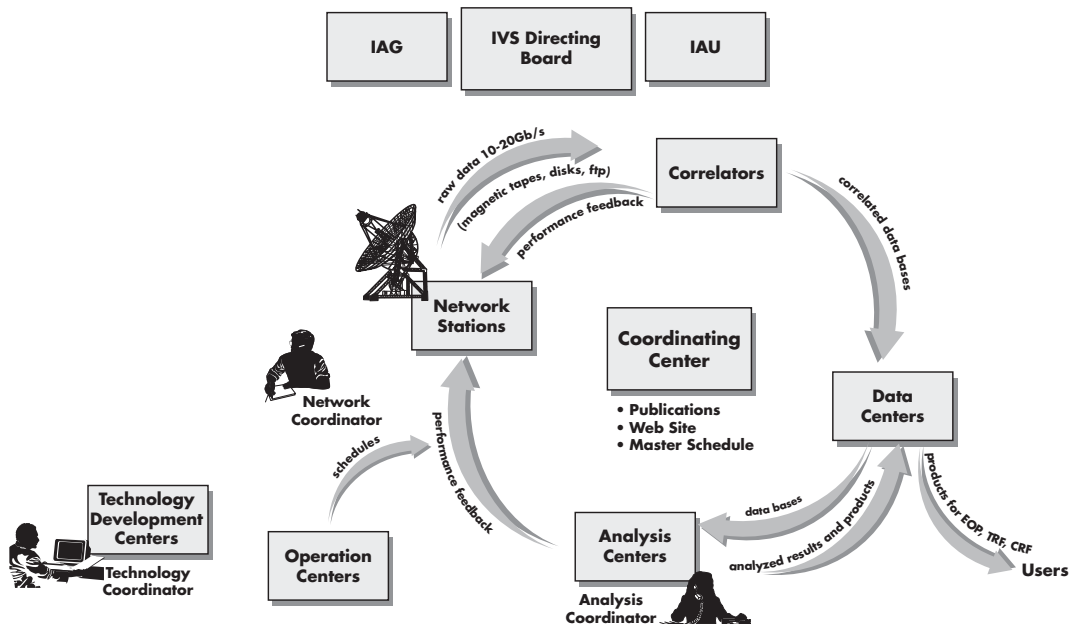

## IVS Member Organizations

The following organizations contribute to IVS by supporting one or more IVS components. They are considered IVS Members. Listed alphabetically by country.

Organization	Country
Geoscience Australia	Australia
University of Tasmania	Australia
Vienna University of Technology	Austria
Centro de Rádio Astronomia e Aplicações Espaciais	Brazil
Space Geodynamics Laboratory	Canada
Geodetic Survey Division, Natural Resources Canada	Canada
Dominion Radio Astrophysical Observatory	Canada
Canadian Space Agency	Canada
Universidad de Concepción	Chile
Instituto Geográfico Militar	Chile
Chinese Academy of Sciences	China
Observatoire de Paris	France
Observatoire de Bordeaux	France
Deutsches Geodätisches Forschungsinstitut	Germany
Bundesamt für Kartographie und Geodäsie	Germany
Institut für Geodäsie und Geoinformation der Universität Bonn	Germany
Forschungseinrichtung Satellitengeodäsie, TU-Munich	Germany
Max-Planck-Institut für Radioastronomie	Germany
Istituto di Radioastronomia INAF	Italy
Agenzia Spaziale Italiana	Italy
Geographical Survey Institute	Japan
National Institute of Information and Communications Technology	Japan
National Astronomical Observatory of Japan	Japan
National Institute of Polar Research	Japan
Norwegian Defence Research Establishment	Norway
Norwegian Mapping Authority	Norway
Astronomical Institute of St.-Petersburg University	Russia
Institute of Applied Astronomy	Russia
Pulkovo Observatory	Russia
Sternberg Astronomical Institute of Moscow State University	Russia
Hartebeesthoek Radio Astronomy Observatory	South Africa
Korea Astronomy and Space Science Institute	South Korea
Instituto Geográfico Nacional	Spain
Chalmers University of Technology	Sweden

Organization	Country
Main Astronomical Observatory, National Academy of Sciences, Kiev	Ukraine
Laboratory of Radioastronomy of Crimean Astrophysical Observatory	Ukraine
NASA Goddard Space Flight Center	USA
U. S. Naval Observatory	USA
Jet Propulsion Laboratory	USA

## IVS Affiliated Organizations

The following organizations cooperate with IVS on issues of common interest, but do not support an IVS component. Affiliated Organizations express an interest in establishing and maintaining a strong working association with IVS to mutual benefit. Listed alphabetically by country.

## Products

### The VLBI technique contributes uniquely to

- Definition and realization of the International Celestial Reference Frame (ICRF)
- Monitoring of Universal Time (UT1) and length of day (LOD)
- Monitoring the coordinates of the celestial pole (nutation and precession)

Organization	Country
Australian National University	Australia
University of New Brunswick	Canada
FÖMI Satellite Geodetic Observatory	Hungary
Joint Institute for VLBI in Europe (JIVE)	Netherlands
Westerbork Observatory	Netherlands
Auckland University of Technology	New Zealand
National Radio Astronomy Observatory	USA

### Further significant products are

- All components of Earth Orientation Parameters at regular intervals
- Station coordinates and velocity vectors for the realization and maintenance of the International Terrestrial Reference Frame (ITRF)

All VLBI data and results in appropriate formats are archived in data centers and publicly available for research in related areas of geodesy, geophysics and astrometry.

# IVS Component Map

## IVS Components by Country

Country	Qty.
Australia	2
Austria	1
Brazil	1
Canada	1
Chile	1
China	3
France	3
Germany	8
Italy	7
Japan	12
Norway	3
Russia	9
South Africa	1
South Korea	1
Spain	1
Sweden	3
Ukraine	2
USA	16
<b>Total</b>	<b>75</b>

A complete list of IVS Permanent Components is in the IVS Information section of this volume.

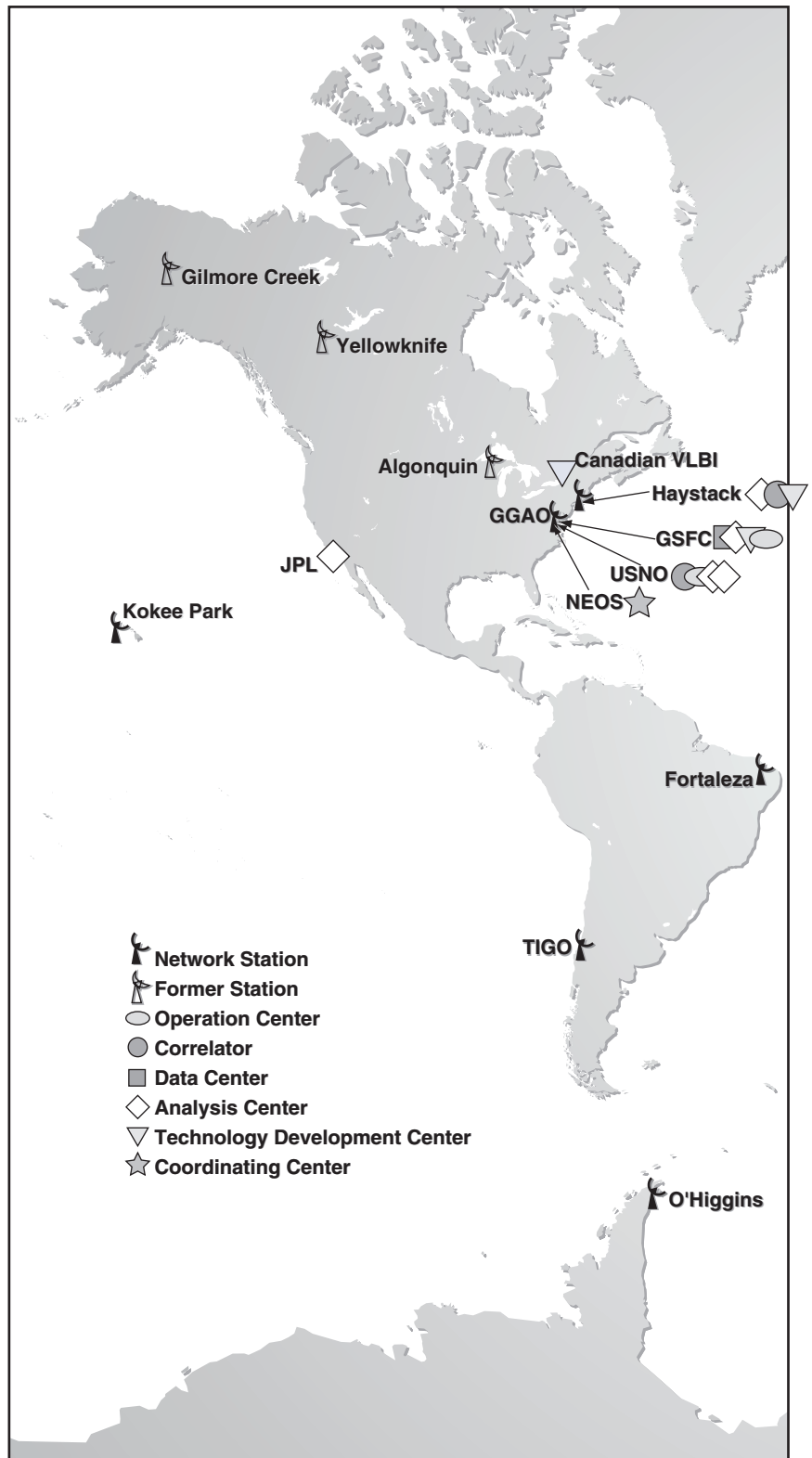



# IVS Directing Board



NAME: Harald Schuh  
AFFILIATION: Vienna University of Technology, Austria  
POSITION: Chair and IAG Representative  
TERM: ex officio



NAME: Hayo Hase  
AFFILIATION: Bundesamt für Kartographie und Geodäsie/TIGO, Germany/Chile  
POSITION: Networks Representative  
TERM: Feb 2007 to Feb 2011



NAME: Dirk Behrend  
AFFILIATION: NVI, Inc./Goddard Space Flight Center, USA  
POSITION: Coordinating Center Director  
TERM: ex officio



NAME: Ed Himwich  
AFFILIATION: NVI, Inc./Goddard Space Flight Center, USA  
POSITION: Network Coordinator  
TERM: permanent



NAME: Patrick Charlot  
AFFILIATION: Bordeaux Observatory, France  
POSITION: IAU Representative  
TERM: ex officio



NAME: Kerry Kingham  
AFFILIATION: U.S. Naval Observatory, USA  
POSITION: Correlators and Operation Centers Representative  
TERM: Feb 2007 to Feb 2011



NAME: Andrey Finkelstein  
AFFILIATION: Institute of Applied Astronomy, Russia  
POSITION: At Large Member  
TERM: Feb 2007 to Feb 2009



NAME: Chopo Ma  
AFFILIATION: NASA Goddard Space Flight Center, USA  
POSITION: IERS Representative  
TERM: ex officio



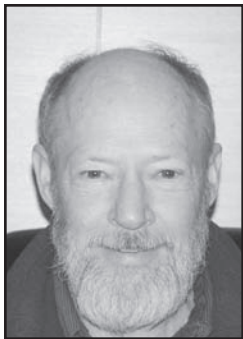

NAME: Arthur Niell  
 AFFILIATION: Haystack Observatory, USA  
 POSITION: Analysis and Data Centers Representative  
 TERM: Feb 2005 to Feb 2009



NAME: Kazuhiro Takashima  
 AFFILIATION: Geographical Survey Institute, Japan  
 POSITION: Networks Representative  
 TERM: (Feb 2007) to Feb 2009



NAME: Ray Norris  
 AFFILIATION: Australia Telescope National Facility, Australia  
 POSITION: FAGS Representative  
 TERM: ex officio



NAME: Oleg Titov  
 AFFILIATION: Geoscience Australia, Australia  
 POSITION: At Large Member  
 TERM: Feb 2007 to Feb 2009



NAME: Axel Nothnagel  
 AFFILIATION: University of Bonn, Germany  
 POSITION: Analysis Coordinator  
 TERM: permanent



NAME: Alan Whitney  
 AFFILIATION: Haystack Observatory, USA  
 POSITION: Technology Coordinator  
 TERM: permanent



NAME: William Petrachenko  
 AFFILIATION: National Resources Canada, Canada  
 POSITION: Technology Development Centers Representative  
 TERM: Feb 2005 to Feb 2009



NAME: Xiuzhong Zhang  
 AFFILIATION: Shanghai Astronomical Observatory, China  
 POSITION: At Large Member  
 TERM: Feb 2007 to Feb 2009

# IVS Chair's Report

Harald Schuh,  
Institute of Geodesy and Geophysics, Vienna University  
of Technology

With the 2008 Annual Report, the IVS components report their progress and activities, which were conducted during the service's tenth year of existence. I would like to thank all IVS Associate Members for their contributions over the course of the year, in particular for providing their reports on time. The timely appearance of the Annual Report is always an ambitious goal, and allows this volume to be used as a real information exchange tool for the community and related groups, which is highly appreciated. I thank the editors for the timely release.

In 2008, IVS observing activities expanded at a rate comparable to the previous year, a fact that in view of the limited resources can be attributed to optimized coordination by the Coordinating Center and strong support from all components. I would like to thank the staff of the Coordinating Center who bear much responsibility and carry a heavy burden for the entire service activities. Day-to-day work is carried out continuously by the Network Stations, the Correlators, the Data Centers, and the Analysis Centers and is the basis for the regular provision of precise IVS products. Now I would like to emphasize those activities performed in 2008 that go beyond the normal work load.

## **IVS Contribution to the Global Geodetic Observing System (GGOS)**

Integration and combination in the framework of the Global Geodetic Observing System (GGOS) of the International Association of Geodesy will be the main challenge for the international geodesy in the next decades. GGOS will go beyond the integration of geodetic techniques (VLBI, SLR, GNSS, DORIS) as it also includes techniques measuring terrestrial gravity, the global Earth gravity field, sea level, and even the magnetic field. Thus, a consistent combination of all geometric and physical techniques will be finally required. GGOS plays an essential role in helping to solve environmental and societal problems. Many open questions related to global change, sea level rise, or the prevention of natural hazards need precise reference frames and exact geodetic measurements; VLBI can give a critical contribution to GGOS by its relation to a quasi-inertial celestial reference frame and its unique ability to measure long-term UT1-UTC and precession/nutation. One of the IVS main tasks in 2008 was to continue its contribution as an efficient and reliable partner within GGOS and also to increase the awareness in the public and in the scientific community about the importance of VLBI. Several GGOS events

were attended in 2008 with presentations about the IVS and its next generation VLBI2010 system. The IVS is well represented in the GGOS Steering Committee.

## **VLBI2010 and the VLBI2010 Committee (V2C)**

The VLBI2010 Committee (V2C), which was established by the IVS Directing Board in 2005, is tasked with promoting the ambitious goals set by the VLBI2010 report, released by the IVS Working Group 3, "VLBI2010: Current and Future Requirements for Geodetic VLBI Systems". The V2C chaired by Bill Petrachenko has been extremely busy in 2008 with frequent telecons and additional face-to-face meetings. All results have been summarized in the excellent VLBI2010 Progress Report with recommendations that can be used as benchmarks for new VLBI systems. The VLBI2010 Progress Report is a very important part of the IVS Annual Report. I would like to thank all members of the V2C for taking over the responsible leading role in the realization of the VLBI2010 visions.

VLBI2010 is supposed to provide not only the visions but also very detailed specifications for future VLBI systems. Right now several countries have already decided to develop or purchase new VLBI systems. It is highly appreciated that Geoscience Australia (GA), Australia; Auckland University of Technology (AUT), New Zealand; Korea Astronomy & Space Science Institute (KASI) and National Geographic Information Institute (NGII), Korea; the Bundesamt für Kartographie und Geodäsie (BKG), Germany, Instituto Geográfico Nacional (IGN), Spain together with the Regional Government of the Azores, Portugal started or continued their activities to implement new telescopes to support the vision of VLBI2010. I would like to congratulate them on the ambitious projects and wish them success in the coming years. Thus, already now more than 10 VLBI2010 type antennas have been approved with more proposal or plans under consideration or even in review in countries like Norway, Russia, Finland, and Saudi Arabia. With new antennas and the expected re-opening of the Fairbanks radio telescope, the global coverage of geodetic VLBI is getting better but it is still far from optimal. Thus, ideas and proposals for new stations are still more than welcome.

## **IVS Working Group 4 on “VLBI Data Structures”**

The IVS Working Group on “VLBI Data Structures” was established in September 2007 as a response to a strong need of new, common VLBI data structures. This Working Group examines the data structure currently used in VLBI data processing and investigates what data structure is likely to be needed in the future. It designs a data structure that meets current and anticipated requirements for individual VLBI sessions, including a cataloging, archiving and distribution system. Further, it prepares the transition capability through conversion of the current data structure as well as cataloging and archiving softwares to the new VLBI2010 system. John Gipson, Chair of Working Group 4, gave a first presentation at the IVS General Meeting in Saint Petersburg.

## **Events in 2008**

In March 2008, we held our fifth General Meeting in St. Petersburg, Russia. In conjunction with the General Meeting, an IVS Analysis Workshop, a V2C meeting, a meeting of the IVS/IERS Working Group on the second realization of the ICRF, and the 19th Directing Board Meeting were organized. The Proceedings of the 5th IVS General Meeting have been published with Andrey Finkelstein and Dirk Behrend as editors, demonstrating the great success of the meeting. I would like to thank the Local Organizing Committee, whose members were Andrey Finkelstein, Alexander Ipatov, Sergey Smolentsev, Nadia Shuygina, and Elena Skurikhina, for the excellent organization. I thank also Professor Alexander Viktorov, Minister of Science and Education of the St. Petersburg Government for his warm welcome address and for supporting the meeting. The Institute of Applied Astronomy (IAA) is deeply thanked for providing the meeting facilities and for the great hospitality we received from the Russian colleagues. During that week in St. Petersburg the IVS Chair got a lot of exercise in giving toasts to our Russian hosts, to the ladies, and to VLBI in general.

A very important observing session that took place in 2008 was CONT08, which is expected to provide the most precise and valuable data set VLBI generated so far. During the period August 12-26, 2008 eleven IVS network stations (Hartebeesthoek, Kokee Park, Medicina, Ny lesund, Onsala, Svetloe, TIGO/Concepcion, Tsukuba, Westford, Wettzell, and Zelenchukskaya) carried out continuous observations. Other IAG Services such as IGS, ILRS, and IDS enhanced their activities during the CONT08 period which is important for obtaining the best results through the comparison of the results and the combination of the techniques.

In September 2008, a very efficient face-to-face meeting of several members of the VLBI2010 Committee and the 20th Directing Board Meeting were held at the Dominion Radio Astrophysical Observatory, Penticton, Canada. I take this opportunity to thank Bill Petrachenko for making the meetings successful and the stay a very pleasant one.

In June 2008 the IVS Directing Board issued a call soliciting proposals for the installation and operation of IVS Combination Centers and additional Analysis Centers (Operational ACs and Associate ACs). The existing Associate Analysis Centers were encouraged to apply for becoming Operational Analysis Centers. We are very glad to announce that after carefully reviewing the submitted proposals, two Combination Centers were approved (BKG/DGFI, Germany and KASI, Korea). One new Operational Analysis Center (DGFI, Germany) and one new Associate Analysis Center (Sternberg Astronomical Institute of Moscow State University, Russia) were also accepted. Welcome to the club!

Summary information about all IVS events and activities is available on the IVS homepage <http://ivscc.gsfc.nasa.gov> and in the IVS Newsletters 20, 21, and 22. The Newsletter is an excellent means to transfer information to everybody. The editor team, Dirk Behrend, Hayo Hase, and Heidi Johnson, presented interesting and up-to-date information. Once again, they did an excellent job, which is highly appreciated.

## **Changes in the Directing Board in 2008**

In 2008, the Directing Board member Yoshihiro Fukuzaki (GSI, Japan) withdrew due to personal reasons and was replaced by Kazuhiro Takashima (GSI, Japan). The elections of new Directing Board members for the term 2009 to 2013 were held in December 2008. Gino Tuccari (IRA, Italy) was elected as Networks Representative, Oleg Titov (Geoscience Australia) as the Analysis and Data Centers Representative, and Rüdiger Haas (OSO, Sweden) as the Technology Development Centers Representative. For the at-large positions (term 2009 to 2011), Andrey Finkelstein (IAA, Russia), Xiuzhong Zhang (SHAO, China), and Kazuhiro Takashima (GSI, Japan) were appointed by the Directing Board in January 2009. I am very pleased that the IVS Directing Board is well balanced with respect to geographic diversity, component representation, and experience. The new Directing Board will commence its work in February 2009.

# IVS Chair's Report Continued

## **IVS Highlights in the Coming Year 2009**

On March 18-20, 2009, the IVS VLBI 2010 Workshop on Future Radio Frequencies and Feeds will take place in Wettzell/Höllenstein (Germany)—another important milestone for the IVS on the way to realizing VLBI2010.

In the week after that (from March 23, 2009) the 19th European VLBI for Geodesy and Astrometry (EVGA) Working Meeting and the IVS Analysis Workshop will be held in Bordeaux (France) and the IVS/IERS Working Group on the second realization of the ICRF will also meet. A special highlight will certainly become the IVS 10th Anniversary Celebration on March 25, 2009, almost exactly 10 years after the IVS started to officially exist.

Finally, I would like to mention the plan for a “VLBI supersession” which is likely to be scheduled on November 18, 2009 with about 30 radio telescopes, the largest geodetic VLBI session that ever took place, as the IVS contribution to the International Year of Astronomy 2009.



**Special Reports**



**Special Reports**



# Design Aspects of the VLBI2010 System

## Progress Report of the IVS VLBI2010 Committee

Bill Petrachenko<sup>1</sup> (chair), Arthur Niell<sup>2</sup>, Dirk Behrend<sup>3</sup>, Brian Corey<sup>2</sup>,  
Johannes Böhm<sup>4</sup>, Patrick Charlot<sup>5</sup>, Arnaud Collioud<sup>5</sup>, John Gipson<sup>3</sup>,  
Rüdiger Haas<sup>6</sup>, Thomas Hobiger<sup>7</sup>, Yasuhiro Koyama<sup>7</sup>, Dan MacMillan<sup>3</sup>,  
Zinovy Malkin<sup>8</sup>, Tobias Nilsson<sup>6</sup>, Andrea Pany<sup>4</sup>, Gino Tuccari<sup>9</sup>,  
Alan Whitney<sup>2</sup>, Jörg Wresnik<sup>4</sup>

<sup>1</sup>*Natural Resources Canada, Canada*

<sup>2</sup>*Haystack Observatory, Massachusetts Institute of Technology, USA*

<sup>3</sup>*NVI, Inc./Goddard Space Flight Center, USA*

<sup>4</sup>*Institute of Geodesy and Geophysics, University of Technology, Vienna, Austria*

<sup>5</sup>*Bordeaux Observatory, France*

<sup>6</sup>*Onsala Space Observatory, Chalmers University of Technology, Sweden*

<sup>7</sup>*Kashima Space Research Center, NICT, Japan*

<sup>8</sup>*Pulkovo Observatory, Russia*

<sup>9</sup>*Radio Astronomy Institute, Italian National Astrophysical Institute, Italy*

April 17, 2009

## Executive Summary

In September 2005 the IVS Directing Board accepted the final report of its Working Group 3 (WG3) entitled “VLBI2010: Current and Future Requirements for Geodetic VLBI Systems”. This bold vision for the future recommended a review of all current VLBI systems and processes from antennas to analysis and outlined a path to a next-generation system with unprecedented new capabilities:

- 1-mm position accuracy on global scales,
- continuous measurements for time series of station positions and Earth orientation parameters,
- turnaround time to initial geodetic results of less than 24 hours.

Immediately following the acceptance of the WG3 final report, the IVS established the VLBI2010 Committee (V2C) to carry out a series of studies recommended by WG3 and to encourage the realization of the new vision for geodetic VLBI. Since its inception, the V2C has accomplished much towards this goal. This report summarizes the work of the committee through the end of 2008.

*Monte Carlo simulations.* Making rational design decisions for VLBI2010 requires an understanding of the impact of new strategies on the quality of VLBI products. Monte Carlo simulators were developed to serve this purpose. They have been used to study the effects of the dominant VLBI random error processes (related to the atmosphere, the reference clocks, and the delay measurement noise) and the benefit of new approaches to reduce them, such as decreasing the source-switching interval and improving analysis and scheduling strategies. Of particular merit is shortening the source-switching interval, which results in a nearly proportionate improvement in station position accuracy. Regardless of the strategy employed, the simulators also confirm that the dominant error source is the atmosphere. It is recommended that research into better ways to handle the atmosphere continues to be a priority for the IVS.

*System considerations, system description, and NASA proof-of-concept test.* Based on the Monte Carlo studies, a high priority is placed on finding strategies for reducing the source-switching interval. This entails decreasing both the on-source time needed to make a precise delay measurement and the time required to slew between sources. From these two somewhat competing goals, recommendations for the VLBI2010 antennas are emerging, e.g., either a single 12-m diameter antenna with very high slew rates, e.g., 12°/s in azimuth, or a pair of 12-m diameter antennas, each with more moderate slew rates, e.g., 5°/s in azimuth.

In order to shorten the on-source observing time, it is important to find a means for measuring the delay with the requisite precision even at a modest signal-to-noise ratio. To do this a new approach is being developed in which several widely spaced frequency bands are used to unambiguously resolve the interferometric phase. The new observable is being referred to as the broadband delay. A four-band system is recommended that uses a broadband feed to span the entire frequency range from 2 to 14 GHz. In order to detect an adequate number of high-quality radio sources, a total instantaneous data rate as high as 32 Gbps and a sustained data storage or transmission rate as high as 8 Gbps are necessary. Since the broadband delay technique is new and untested, NASA is funding a proof-of-concept effort. First fringes have been detected in all bands.

It is also recognized that reducing systematic errors plays a critical role in improving VLBI accuracy. For electronic biases, updated calibration systems are being developed. For antenna deformations, conventional surveying techniques continue to be refined, while the use of a small reference antenna for generating deformation models and establishing site ties is also under consideration. For errors due to source structure, the application of corrections based on images derived directly from the VLBI2010 observations is under study.



*Operational considerations.* It is recommended that a globally distributed network of at least 16 VLBI2010 antennas observes every day to determine Earth orientation parameters, and that other antennas be added as needed for the maintenance of the celestial and terrestrial reference frames. A subset of antennas with access to high-speed fiber networks is also required to enable daily delivery of initial IVS products in less than 24 hours. A high priority is placed on increasing the number of stations in the southern hemisphere. Since IVS products must be delivered without interruption, a transition period to VLBI2010 operations is required in which there will be a mix of antennas with current and next-generation receiving systems. For this period a compatibility mode of operation has been identified and tested to a limited extent with the NASA proof-of-concept system. In order to increase reliability and to reduce the cost of operations, enhanced automation will be introduced both at the stations and in the analysis process. Stations will be monitored centrally to ensure compatible operating modes, to update schedules as required, and to notify station staff when problems occur. Automation of the analysis process will benefit from the work of IVS Working Group 4, which is updating data structures and modernizing data delivery.

*Risks and fallback options.* There are a number of risks to successful implementation of VLBI2010, the most significant of which follow.

- Because of the smaller size of the VLBI2010 antenna and greater density of observations, a significant increase in data volume and hence shipping and/or transmission costs is anticipated. It is expected that future technological advances will reduce these costs. In the interim less data-intensive operating modes may be employed.
- Radio frequency interference (RFI) is an ever increasing problem in the VLBI2010 spectrum. Fortunately, VLBI is comparatively insensitive to RFI, and the VLBI2010 system is being designed to be resilient against it.
- The broadband delay technique has not been demonstrated. Known risks come from RFI and source structure. The NASA proof-of-concept test is now poised to make its first broadband observations to verify the feasibility of the new technique. In the event that problems are identified, less attractive but adequate fallback options have been defined.
- VLBI2010 is now well on the way to definition of requirements and recommendations for subsystem specifications. However, the current rather informal organization through the V2C may not be adequate to move to the next level of defining development and deployment schedules and soliciting contributions. It is recommended that a small project coordinating executive group be established.

*Next steps.*

- Continue the NASA proof-of-concept effort.
- Continue defining subsystem recommendations.
- Promote the expansion of the VLBI2010 network.
- Develop a short-baseline research network.
- Begin development and testing of a small reference antenna for generating antenna deformation models and automatic site tie procedures.
- Improve algorithms for scheduling observations.
- Extend the source structure studies to the analysis of real S/X data.
- Develop VLBI2010 analysis strategies including automation.

# 1 Introduction

## 1.1 Background

In September 2003 the IVS, recognizing the limitations of existing VLBI infrastructure and the increasingly demanding requirements of space geodesy, established Working Group 3 (WG3): VLBI2010 ([Niell et al., 2006](#)) to investigate options for modernization.

Guided by emerging space geodesy science and operational needs, WG3 established challenging goals for the next generation VLBI system, including:

- 1 mm position accuracy on global scales,
- continuous measurements for time series of station positions and Earth orientation parameters,
- turnaround time to initial geodetic results of less than 24 hours.

In its final report, WG3 proposed strategies to move toward the unprecedented 1 mm position accuracy target and broad recommendations for a next generation system based on the use of smaller (~12 m) fast-slewing automated antennas. To help make these recommendations more specific, the report additionally suggested a series of 13 studies and development projects. In order to encourage the realization of the WG3 recommendations, the IVS established the VLBI2010 Committee (V2C) in September 2005. This report summarizes the work of the committee through the end of 2008.

## 1.2 Overview of the Report

In Section 2 of this report, Monte Carlo simulators developed by the V2C are described, along with their application in studies to better understand the response of the VLBI system to error processes and to determine the benefit of proposed strategies for improving performance. In Section 3 the implications of these studies and known systematic errors for system design are considered. Section 4 describes the current definition of the VLBI2010 system and Section 5 describes the status of the NASA broadband delay proof-of-concept effort. In Section 6 operational considerations for VLBI2010 are presented. Section 7 treats risks to the successful implementation of VLBI2010 and fallback options for those risks. Section 8 proposes next steps for the project.

## 2 Monte Carlo Simulations

Rational design decisions for VLBI2010 must be based on a realistic understanding of the impacts of new operating modes on final products. These impacts are difficult to evaluate analytically due to complex interactions in the VLBI analysis process and are impractical to evaluate with real data due to the high cost of VLBI systems and operations ([Petrachenko, 2005](#)).

To fill this gap, the V2C developed Monte Carlo simulators. These simulators have subsequently been used extensively to study the strategies suggested in the IVS WG3 final report ([Niell et al., 2006](#)) for reaching the VLBI2010 target of 1 mm position accuracy.

In this section the V2C Monte Carlo simulators are described, and results of the simulation studies are summarized. The studies include investigations of the impact on final products of:

- scheduling strategies,
- source-switching interval,
- analysis strategies,
- random error sources, including:

- variations in the rates of the VLBI reference clocks,
- errors in the delay observable measurements,
- delays due to the wet atmosphere above each antenna,
- network size.

In Section 2.7 the simulators are validated in a comparison with real data, and in Section 2.8 some inferences for future VLBI systems and observing strategies are drawn from the simulation results.

## 2.1 Description of the V2C Monte Carlo Simulators

The concept of a Monte Carlo simulator is simple. Several sets of input data are generated analytically from realistic models for the error processes, with each set driven by different random numbers. All data sets are then processed as if they were from real sessions, and the ensemble of output products is analyzed statistically to produce estimates of the bias and standard deviation of those products.

In the particular case of the V2C Monte Carlo simulators, the stochastic processes included are those related to the reference clocks, the wet atmosphere, and the delay measurement noise. The relation of these processes to the ‘\_observed minus computed’ (*o-c*) VLBI delay observables is expressed in Equation (2-1):

$$(o-c) = (zwd_2 \cdot mfw_2 + clk_2) - (zwd_1 \cdot mfw_1 + clk_1) + wn \quad (2-1)$$

The parameters  $zwd_1$  and  $zwd_2$  are the zenith wet delays at stations 1 and 2, respectively,  $mfw_1$  and  $mfw_2$  are the wet mapping functions,  $clk_1$  and  $clk_2$  are the clock values, and  $wn$  is the white noise added per baseline observation to account for the instrumental thermal noise. No other error sources (either random or systematic) are currently incorporated into the Monte Carlo simulators.

The simulated zenith wet delays are based on a turbulence model following [Nilsson et al. \(2007\)](#). A detailed description of the model, together with values for the structure constants  $C_n$ , effective wet heights  $H$ , and wind velocities  $\bar{v}$ , is provided in Appendix A. The wet mapping functions  $mfw$  are assumed to be perfectly known, as are the hydrostatic delays. Clocks are simulated as the sum of a random walk and an integrated random walk, both corresponding to a certain Allan Standard Deviation (ASD) (Herring et al., 1990). Source code for the simulation of clock values and the wet delays is provided by [Böhm et al. \(2007\)](#).

VLBI2010 Monte Carlo simulations are based on a set of twenty-five 24-hour sessions; i.e., for each observing schedule, 25 sessions of artificial observations (*o-c*) are generated. All parameters, such as  $C_n$ ,  $H$ ,  $\bar{v}$ , and clock ASD, are identical for each session, and only the random numbers driving the processes are changed. Geodetic parameters such as station coordinates are estimated for each session, and the biases and standard deviations of the estimates are calculated for the ensemble of 25 sessions.

Monte Carlo simulations have been carried out with three estimation packages:

- *Solve* ([MacMillan, 2006](#)) at the Goddard Space Flight Center,
- *OCCAM* ([Wresnik and Böhm, 2006](#)) at the Institute of Geodesy and Geophysics (IGG) in Vienna,
- Precise Point Positioning (PPP) ([Pany et al., 2008a](#)) at the IGG in Vienna.

While the *Solve* solutions are determined by a classical least-squares adjustment (Gauss-Markov model) and the *OCCAM* solutions are determined with a Kalman filter, the PPP software can do

both classical least-squares adjustments and Kalman filter solutions. Although the PPP software is somewhat unrealistic for VLBI, since it treats only one antenna at a time, the results generally agree well with the more complete solutions of *Solve* and *OCCAM*. PPP has the advantage of being easy to enhance for new processing modes.

The Monte Carlo simulators are only as realistic as the models used to generate the simulated input data. Efforts continue to improve those models ([Nilsson and Haas, 2008](#); [MacMillan, 2008](#); [Wresnik et al., 2008a](#)). Effects such as thermal and gravitational deformations of the antennas, source structure, mapping-function errors, hydrostatic atmosphere errors (Böhm et al., 2006; [Niell, 2006a](#)), and errors in the geophysical models are not modeled in the simulators. Those effects are instead addressed through careful system design, calibration, and external measurements (Sections 3 and 4).

## 2.2 Scheduling Strategies

Traditionally, the stochastic behaviors of both the wet component of the atmosphere and the hydrogen maser reference oscillators have been extracted directly from the VLBI data. The separation of these effects from the geometric parameters of interest has been achieved through the use of optimized schedules in which source direction varies significantly during the course of each stochastic estimation interval.

New VLBI2010 operating modes will require a different conceptualization of scheduling strategies. In particular, the anticipated use of globally distributed networks and ultra-short source-switching intervals opens interesting new scheduling possibilities, two of which have been investigated to date.

The first possibility is a straightforward extension of the well-known Goddard Space Flight Center (GSFC) scheduling program, *sked*, which is currently used operationally to schedule IVS sessions. The primary goal for the new *sked* VLBI2010 optimization is to maximize the total number of observations in a session. Principal criteria for generating these schedules are:

- maximization of the number of stations in a scan,
- minimization of slew times between scans.

Although the latter condition results in sources being observed in clusters, it was reasoned that the short source-switching intervals would lead to sufficiently large clusters to achieve adequate sky coverage at each station over a short period of time.

At Natural Resources Canada (NRCan) a second effort was initiated to produce schedules guaranteed to have uniform sky coverage over short intervals. Principal rules for generating these schedules are:

- regular source-switching intervals,
- simultaneous observation of two sources roughly  $180^\circ$  apart with nearly all stations being able to see either one source or the other at any given time,
- uniform coverage of the celestial sphere over short intervals.

Both scheduling strategies have been evaluated extensively by the V2C. Their performance with respect to position error is nearly identical. However, the regular source-switching intervals used by the uniform sky schedules enable a more generalized study of antenna slew rate requirements. For consistency, the uniform sky schedules have been used exclusively in the studies reported in this document.

For the practical generation of the schedules, catalogs of suitable radio sources and stations are required. A list of 230 strong, nearly structureless radio sources, which was developed by Leonid Petrov specifically for geodetic applications ([Petrov, 2007](#)), is the basis for all schedules used in these studies.

With respect to stations, hypothetical networks of 16, 24, and 32 stations were developed specifically for the Monte Carlo studies ([Niell, 2007](#)). The primary criterion for the networks was to approach a uniform global distribution, although realism was introduced by requiring that the stations be on land near existing International GNSS Service (IGS) stations. Due to the paucity of continental land-mass in the southern hemisphere, the distribution of stations is worse there than in the north.

Research into scheduling strategies remains a priority for VLBI2010. A corresponding research project has been funded and will start at IGG Vienna in January 2009.

### 2.3 Source-switching Interval

In the WG3 final report ([Niell et al., 2006](#)) it was proposed that the source-switching interval be decreased dramatically. To test the impact of this strategy on performance, eight uniform sky schedules were generated with regular source-switching intervals of 15, 30, 45, 60, 90, 120, 240, and 360 s. The upper limit of 360 s was chosen to represent performance typical of current observations.

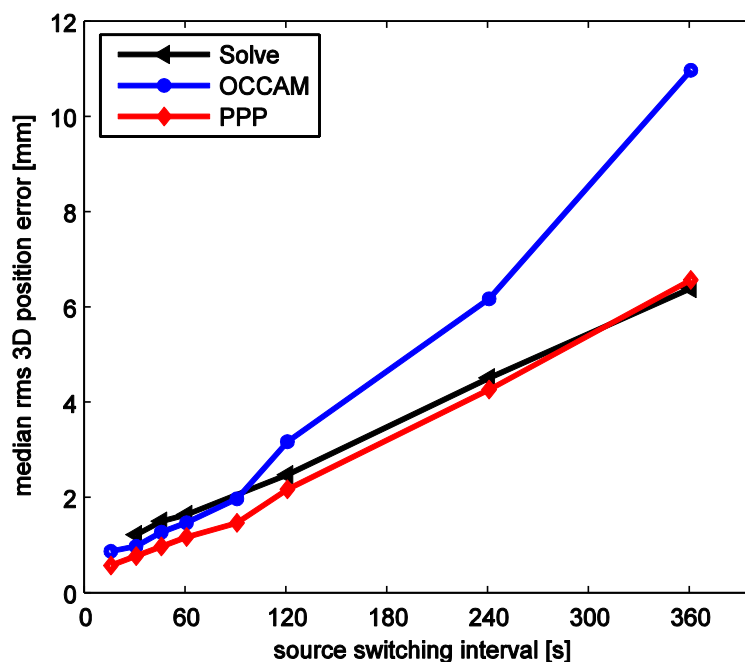

**Figure 2-1. Median of the rms 3D position errors for uniform sky schedules with regular source-switching intervals ranging from 15 to 360 s. The delay measurement noise was 4 ps per baseline observation, the clock Allan Standard Deviation was  $1 \cdot 10^{-14}$  @ 50 minutes, and the turbulence parameters were those tabulated in Appendix A. It is believed that the poorer performance of *OCCAM* at longer intervals is due to the fact that its Kalman filter solutions were specifically tuned for shorter source-switching intervals.**

The primary quantity that has been used throughout the simulation studies to characterize performance is the median of the rms 3D position errors for the network for a 24-hour session. This is shown in Figure 2-1 to 2-5 for a 16-station network.

In Figure 2-1 the trends of the curves for the three analysis packages indicate impressive improvement from the longest to the shortest source-switching interval. For this reason the results in Figure 2-1 are used in Sections 3.1 and 3.2 as important constraints for recommendations of system parameters, such as sustained data rate, antenna diameter, and slew rates.

## 2.4 Analysis Strategies

The new VLBI2010 operating modes, with their greater observation density, more precise delay observables, and larger number of stations per scan, have stimulated a review of optimal analysis. The two most important findings are summarized below.

- *Shorter atmosphere estimation intervals.* For Gauss-Markov least-squares analysis, having many more observations per unit time enables the use of shorter atmosphere estimation intervals for zenith wet delays and gradients. For stations near the equator, where there is more water vapor in the atmosphere, the reduction in error can approach a factor of two, although elsewhere it is typically considerably less.
- *Elevation angle weighting.* The relative contribution of atmosphere model errors is enhanced at low-elevation angles as delay precision improves. The impact can be reduced by downweighting low-angle observations. For analyses carried out with weights of  $mfw \cdot 10$  ps added in quadrature to the observation sigma, improvement was found to be largest at about 30% for equatorial stations. A more general atmosphere treatment that includes spatial correlations of observables ([Treuhaft and Lanyi, 1987](#)) should be studied with the Monte-Carlo simulators in the future.

Other analysis options have also been tried, e.g., larger a priori variance-rates for the atmosphere and clocks in the Kalman filter and low-order spherical harmonics for the atmosphere ([Pany et al., 2008c](#)).

## 2.5 Random Errors

As pointed out in Section 2.1, the three main random error sources impacting VLBI results are the variations in the rates of the reference clocks, the delay measurement noise, and the delay of the atmosphere above the stations. In this section we investigate the impact of these error sources one at a time. The following values have been used as defaults in this section.

Clock:	Allan Standard Deviation (ASD) of $1 \cdot 10^{-14}$ @ 50 minutes
Delay measurement noise:	white noise of 4 ps per baseline observation
Turbulence:	structure constant $C_n = 1 \cdot 10^{-7} \text{ m}^{-1/3}$ effective wet height $H = 2 \text{ km}$ wind velocity $\vec{v} = 10 \text{ m/s}$ towards east

The default ASD comes from the analysis of real VLBI sessions, the delay measurement noise is the value anticipated for VLBI2010, and the turbulence values are those suggested by [Treuhaft and Lanyi \(1987\)](#). All analyses used the same 16-station uniform sky schedule with a source-switching interval of 60 s.

The sensitivity analyses were carried out with all three packages. Detailed descriptions of the analyses are provided by [MacMillan and Sharma \(2008\)](#) for the *Solve* solution, by [Wresnik et al. \(2008b\)](#) for the *OCCAM* solution, and by [Pany et al. \(2008b\)](#) for the PPP solution. Major results of these studies are summarized below.

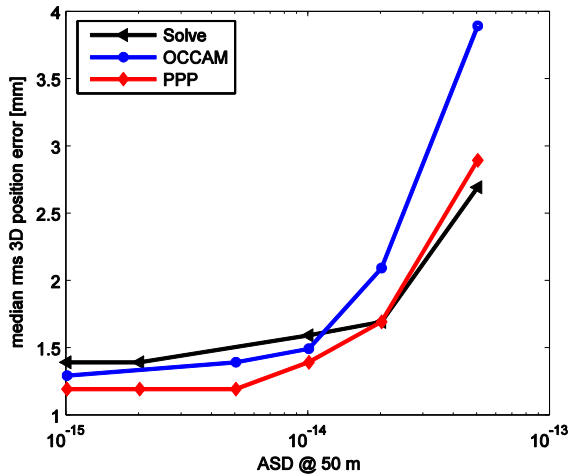

Figure 2-2. Median of the rms 3D position errors versus clock ASD.

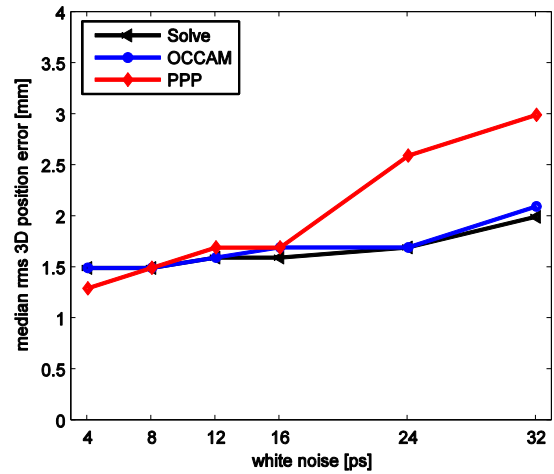

Figure 2-3. Median of the rms 3D position errors versus delay precision.

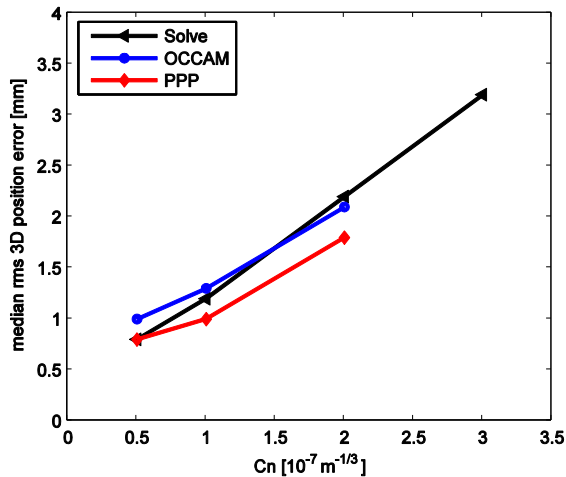

Figure 2-4. Median of the rms 3D position errors versus structure constant  $C_n$  of wet atmosphere.

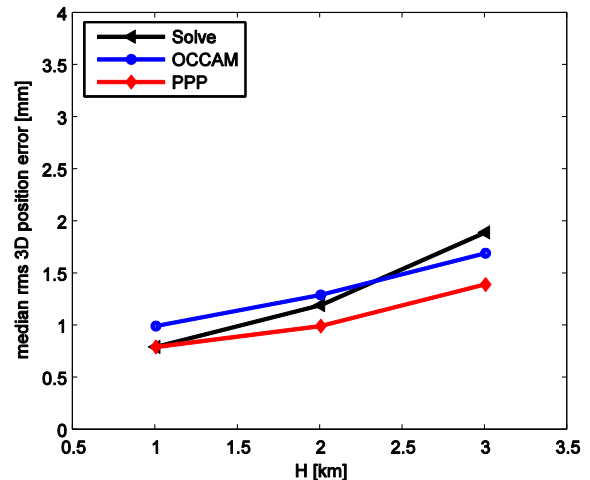

Figure 2-5. Median of the rms 3D position errors versus effective height  $H$  of wet atmosphere.

- In Figure 2-2 it is apparent that, with the VLBI2010 operating modes, geodetic performance is only marginally improved for clock systems that perform better than about  $1 \cdot 10^{-14}$  @ 50 min. The performance measured currently for H-masers and their associated clock distribution systems is typically better than that.
- From Figure 2-3 it can be seen that performance is only slightly dependent on delay measurement noise. The anomalous behavior of the PPP solutions above 16 ps is not at present understood.
- In Figures 2-2 to 2-5, the comparatively strong dependence on  $C_n$  indicates that, even with the high delay measurement precision, short source-switching intervals, and globally distributed networks of VLBI2010, the atmosphere remains the dominant random error source for geodetic VLBI.
- Performance is nearly insensitive to wind speed and the plot is not included.

## 2.6 Network Size

In the WG3 final report larger and better-distributed global networks were recommended as a means of improving VLBI performance for both Earth orientation parameters (EOP) and the scale of the terrestrial reference frame. To test this, uniform sky schedules with 45-second switching interval were generated for the 16-, 24-, and 32-site networks developed for the Monte Carlo simulations (Section 2.2; [Niell, 2007](#)). For generating the input atmosphere delays, the turbulence parameters were set to  $Cn = 2.4 \cdot 10^{-7} \text{ m}^{-1/3}$ ,  $H = 1 \text{ km}$ , and  $\bar{v} = 8 \text{ m/s}$  towards east for all stations.

In Figure 2-6, rms EOP (X-pole, Y-pole, UT1) errors determined by both *OCCAM* and *Solve* are plotted against network size. In Figure 2-7, rms scale errors determined by *OCCAM* are plotted relative to network size. The improvement for the EOP precision and for scale is approximately 30% as the number of stations increases from 16 to 32.

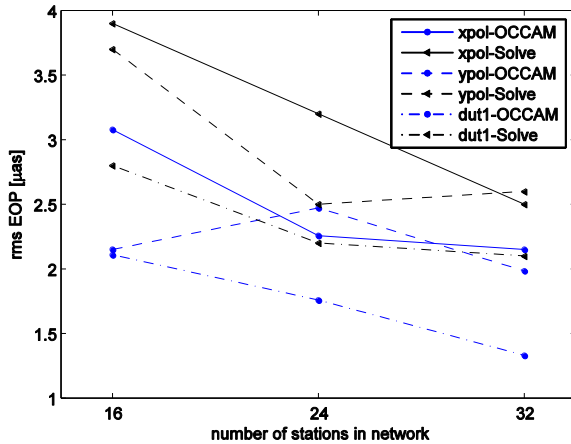

Figure 2-6. rms EOP errors derived from uniform sky schedules with 45-second switching interval and for 16, 24, and 32 stations. Results are plotted for both *OCCAM* and *Solve*.

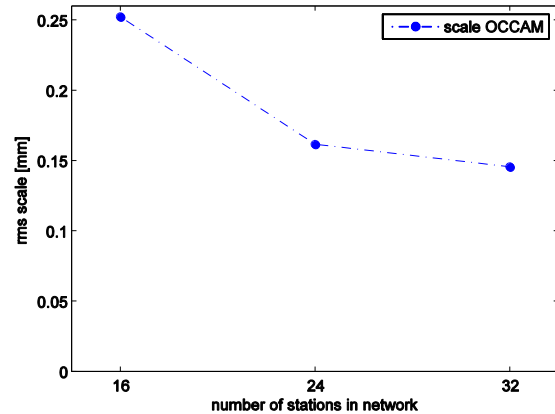

Figure 2-7. rms scale errors of the network (multiplied by the Earth radius) from uniform sky schedules with 45-second switching interval for 16, 24, and 32 stations. Results are for *OCCAM* Kalman Filter.

## 2.7 Validation of the Monte Carlo Simulators

To validate the Monte Carlo simulators, baseline repeatabilities for a 24-hour CONT05 schedule were determined using the simulators and compared to the baseline repeatabilities obtained for the 15 days of actual CONT05 data. For the simulators the clock ASD was set to  $1 \cdot 10^{-14}$  @ 50 minutes, the formal delay errors for each scan were set to those reported for the actual CONT05 observations, and the atmosphere parameters,  $Cn$ ,  $H$ , and  $\bar{v}$ , were set to the station-specific values listed in Appendix A. Since real atmosphere conditions can vary considerably from day to day and the atmosphere parameters for the simulators are based on a simple non-varying latitude dependent model, it was expected that the repeatabilities of the real and simulated data would be close in magnitude and show similar trends but would not be exactly the same.



Figures 2-8 and 2-9 show the actual and simulated CONT05 baseline length repeatabilities derived with the *OCCAM* Kalman filter and *Solve*, respectively. In the case of *OCCAM* the real and simulated repeatabilities are quite close, while for *Solve* the simulated repeatability is somewhat better than that of the real data. The reason for this discrepancy is not fully understood. Based on these results, performance predicted by the simulators is not expected to be optimistic by more than about 30%. Work continues on improving the atmosphere models.

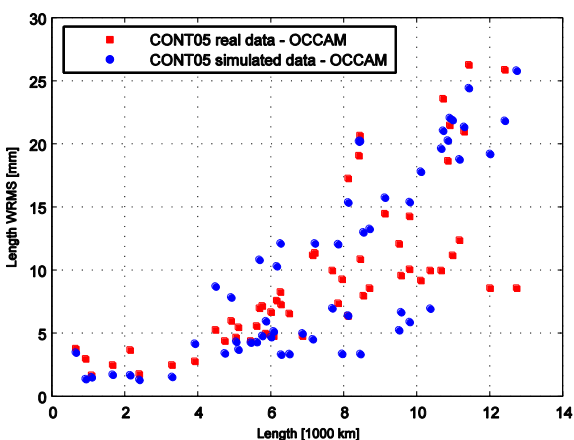

Figure 2-8. *OCCAM* Kalman filter baseline length repeatabilities of the actual CONT05 sessions (red squares) and the simulated sessions (blue circles).

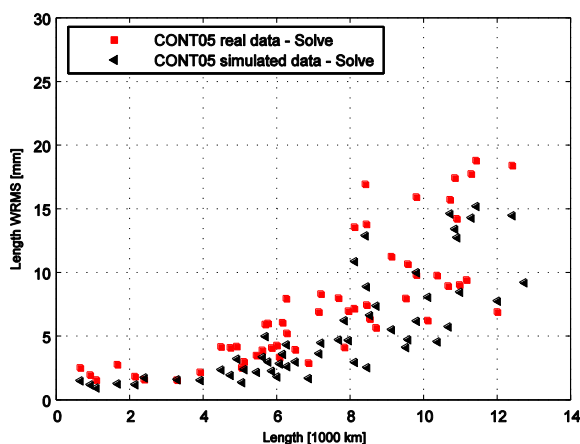

Figure 2-9. *Solve* baseline length repeatabilities of the actual CONT05 sessions (red squares) and the simulated sessions (black triangles).

## 2.8 Other Considerations

It is clear from Figure 2-1 that decreasing the source-switching interval is an effective means for improving geodetic VLBI performance. However, once short source-switching intervals have been implemented, it is interesting to ask what more can be done to reduce the impact of random error sources on the products. In this regard, Figures 2-2 to 2-5 provide valuable guidance. The clear dependence of the position error on  $C_n$  (Figure 2-4) and, to a lesser extent, on  $H$  (Figure 2-5) indicates that the dominant random error source for VLBI2010 operating modes remains the atmosphere. It is important that efforts to improve atmosphere modeling continue. Examples include the further development of water vapor radiometers (WVRs) ([Jacobs et al., 2006a](#); [Bar-Sever et al., 2007](#)); the use of numerical weather models to constrain atmosphere mapping functions, a priori, gradients, and correlations ([Böhm et al., 2006](#); [Eresmaa et al., 2008](#); [Hobiger et al., 2008a](#); [Hobiger et al., 2008b](#)); and the investigation of more novel approaches, such as tomography with an array of GNSS antennas, to improve knowledge of atmosphere anisotropy and temporal variability.

It is also useful to consider the implications of Figures 2-2 and 2-3 for clock performance and delay measurement precision. In the IVS WG3 final report ([Niell et al., 2006](#)), a clock ASD of  $1 \cdot 10^{-16}$  @ 50 minutes and delay measurement precision of 4 ps were recommended. However, the lack of significant dependence of position error on clock performance and delay measurement error indicates that these recommendations may have been unduly stringent. Nevertheless, a compelling reason remains for improving clock stability and delay measurement error. In order to continue the reduction of errors from the atmosphere and from various systematic error sources (Section 3) the effect of different modeling approaches must be visible in the post-fit residuals and in the

repeatability of output products. This visibility is increased when the unmodeled clock error and delay measurement error are reduced.

Since the VLBI2010 system is intended to operate optimally for decades into the future, the clock system and delay measurement process should be designed to keep pace with the anticipated improvements in atmosphere and systematic error modeling so as not to be the limiting factors on product accuracy. It is therefore recommended that clock distribution systems at sites be improved, that developments in clock technology be monitored, and that an effort be made to improve delay precision significantly below today's levels (Section 3.3).

### 3 System Considerations

In the WG3 final report ([Niell et al., 2006](#)), several strategies were proposed to approach the 1-mm VLBI2010 position accuracy target. Of these, four have direct repercussions for VLBI2010 system parameters, namely:

- reduce the average source-switching interval,
- reduce the random component of the delay error (e.g., variation in the rates of the clocks, delay measurement noise, and delay due to the atmosphere),
- reduce systematic errors (e.g., instrumental drifts, antenna deformations, and source structure errors),
- reduce susceptibility to radio frequency interference (RFI).

Detailed studies of the first two strategies were carried out using the Monte Carlo simulators and are summarized in Sections 2.3 and 2.5, respectively, with further discussion in Section 2.8.

In this section the implications for VLBI2010 system parameters of the above WG3 strategies and the associated Monte Carlo studies are presented. The system-related issues that are considered are sensitivity, antenna slew rate, delay measurement error, RFI, frequency requirements, and antenna deformation. Source structure corrections are also covered in this section.

#### 3.1 Sensitivity

Sensitivity is a measure of the weakest radio source that can be usefully observed by a given system. In radio interferometry, it can be expressed as

$$S_{weakest} = \frac{2k \cdot SNR_{min}}{\eta} \cdot \sqrt{\frac{T_{sys_1} \cdot T_{sys_2}}{A_{eff_1} \cdot A_{eff_2}} \cdot \frac{1}{BT}} \quad (3-1)$$

where  $S_{weakest}$  is the flux density of the weakest usable radio source,  $k$  is Boltzmann's constant,  $SNR_{min}$  is the minimum usable signal-to-noise ratio (SNR) per band,  $\eta$  is the VLBI processing factor (typically 0.5–1.0),  $T_{sys_1}$  and  $T_{sys_2}$  are the system temperatures at the two ends of the baseline,  $A_{eff_1}$  and  $A_{eff_2}$  are the effective collecting areas of the antennas,  $B$  is the sample rate per band, and  $T$  is the integration time.

For VLBI2010, competing requirements for short source-switching intervals, for detection of an adequate number of suitable sources, and for moderate overall system cost combine to constrain the possible values for VLBI2010 antenna diameter and data acquisition rate.

It is clear from Figure 2-1 that the source-switching interval must be significantly less than 60 s to approach the VLBI2010 1-mm position accuracy target. The implications are twofold: the antenna must be able to slew quickly between sources, and the on-source period must be short, say ~5 s.

Unfortunately, these two requirements are at odds with each other: high slew rates are easier to achieve with a smaller antenna, whereas larger antennas are more sensitive and can yield a given SNR in a shorter time on source.

As a practical matter, the choice of antenna size for VLBI2010 was driven by proposals for the NASA Deep Space Network (DSN) array and the Square Kilometre Array (SKA) to build thousands of 12-m antennas. The prospect that a low-cost, robust, 12-m antenna with good efficiency (~50%) and low system temperature (~50 K) would be developed for these projects made this size of antenna attractive for VLBI2010. The smaller size of a 12-m compared with the more typical 20-m size of today's IVS antennas should also lessen the difficulties in achieving increased slew rates. However, the question remains whether the smaller antenna can achieve the minimum SNR of 10 per 1-GHz-wide band that is required to securely resolve the broadband delay (Section 3.3) in the ~5 s allotted on each source. Answering this question requires knowledge of source flux densities and of realistic bit rates anticipated for the start of VLBI2010 operations.

Regarding source strength, catalogs of sources with little structure have recently been developed for geodetic applications. In the list of 230 sources produced by Leonid Petrov (cf. Section 2.2), the 185 strongest sources all have correlated flux densities above 250 mJy at both S-band and X-band, even for Earth diameter baselines, and the ninety strongest sources have correlated flux densities above 400 mJy.

Regarding bit rate, the state-of-the-art for sustained data acquisition bit rate is currently around 2 Gbps (1 Gbps =  $10^9$  bits/second), with 4-Gbps systems in an advanced stage of development. Since operations with a significant number of VLBI2010 antennas are not likely to begin for several years, and commercial disc and network capabilities continue to advance rapidly, a sustained bit rate of 8 Gbps is anticipated for the start of VLBI2010 operations. In addition, to further shorten the on-source period, a "burst mode" data acquisition capability is proposed for VLBI2010 in which data are acquired into RAM at a rate four times higher (burst factor of 4) than the record rate, or 32 Gbps. Writing to disk will then continue while the antenna is slewing to the next source.

Under these conditions the average integration time needed to achieve the minimum SNR for the 185 sources in the Petrov list with flux densities above 250 mJy is ~4.5 s ([Petrachenko, 2008c](#)), which corresponds to an average data volume of ~18 Gbytes per scan at each station. Note that an additional 13.5 s are required on average during slewing to complete the write to disk at 8 Gbps. For the 90 sources above 400 mJy the average integration time is 2.5 s, the average data volume per scan is 10 Gbytes, and an additional 7.5 s are required during slewing to finish writing to disk.

In summary, under the assumptions of an 8 Gbps record rate and a burst factor of 4, antennas with 12 m diameter, 50% aperture efficiency, and 50 K system temperature can detect about 185 geodetic-quality radio sources with adequate SNR in the short time span of ~5 s allowed by the necessity of switching rapidly between sources. This defines the minimum diameter of the antennas. However, larger antennas are useful both for maintaining the celestial reference frame (CRF) at lower flux densities and for providing extra SNR margin in the presence of RFI and other hard-to-control external factors.

### 3.2 Antenna Slew Rate

The IVS WG3 final report suggests a major increase in observation density (or, equivalently, a major decrease in source-switching interval) as a strategy for increasing VLBI position accuracy. The simulation results displayed in Figure 2-1 indicate that this strategy is in fact very effective for increasing position accuracy and consequently has been identified as an essential element of VLBI2010. In this section the implication of decreasing source-switching intervals on antenna slew rates and accelerations is considered.

Analysis for this section was carried out in two steps ([Petrachenko et al., 2008](#); [Petrachenko, 2008b](#)).

- Optimized uniform sky schedules and the Monte Carlo simulators were used to develop a relationship between the median of the rms 3D position errors and the source-switching interval.
- The same schedules were then analyzed to produce families of antenna slew rates and accelerations that achieve a specified average source-switching interval.

To constrain the range of possibilities, only two antenna mount types were considered. The first was a standard (STD) azimuth/elevation (az-el) mount with azimuth range  $-270^\circ$  to  $+270^\circ$  and elevation range  $5^\circ$  to  $90^\circ$ . The second was an over-the-top (OTT) az-el mount also with azimuth range  $-270^\circ$  to  $+270^\circ$  but with an elevation range of  $5^\circ$  to  $175^\circ$ . The WG3 final report also proposed the use of multiple antennas at a site to share the observing load and hence to reduce the effective source-switching interval. The case of a second antenna at a site was therefore considered.

To begin the study, four uniform sky schedules ([Petrachenko et al., 2008](#); [Petrachenko, 2008b](#)) were generated having regular source-switching intervals of 15, 30, 45, and 60 s. The results of the Monte Carlo runs are plotted in Figure 3-1.

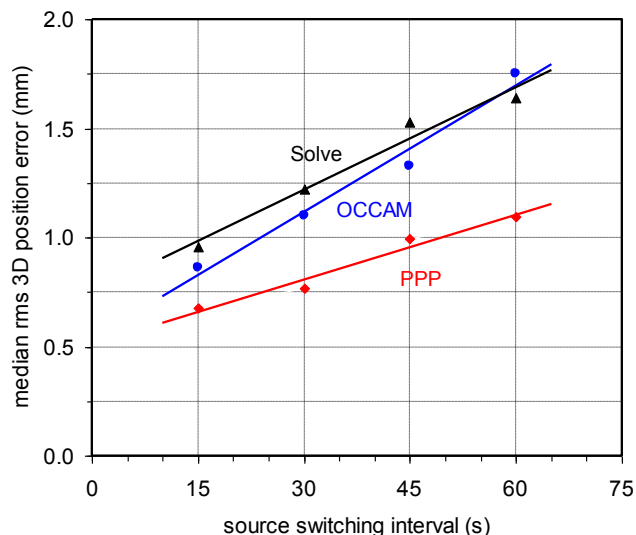

**Figure 3-1. Median of the rms 3D position errors vs. source-switching interval for four uniform sky schedules that were optimized to reduce slew time.**

Based on the *OCCAM* results in Figure 3-1, source-switching intervals were identified to achieve median 3D position errors of 1.0, 1.25, 1.50, and 1.75 mm. The schedules were then re-analyzed to determine all combinations of azimuth and elevation slew rates that achieve each of the above four source-switching intervals. This was done for a number of different slew accelerations. Plots of azimuth vs. elevation slew rate were then generated for the four performance levels, for both mount types, and for either one or two antennas per site. As an example, the case of 1-mm performance for a pair of STD az-el antennas is displayed in Figure 3-2.

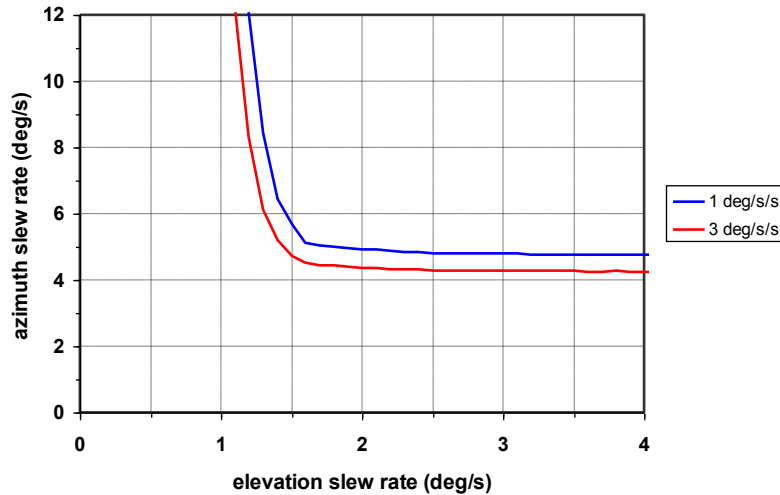

**Figure 3-2. Azimuth and elevation slew rates to achieve 1-mm median of the rms 3D position errors for a pair of STD az-el antennas accelerating at 1 or 3 deg/s/s in both axes.**

Figure 3-3 summarizes the results for one or two antennas at a site of both types. To generate this figure, it was assumed, based on Figure 3-2 and similar figures, that the optimum ratio between the azimuth slew rate and the elevation slew rate is about 3.5:1 for STD mounts, while for the OTT mounts the optimum ratio is about 1:1. Using these ratios, Figure 3-3 gives information about both azimuth and elevation slew rates. Slew accelerations no greater than 1 deg/s/s are required, except for a single antenna at 1-mm position error, in which case an acceleration of 3 deg/s/s is required for the STD mount and 2 deg/s/s for the OTT mount.

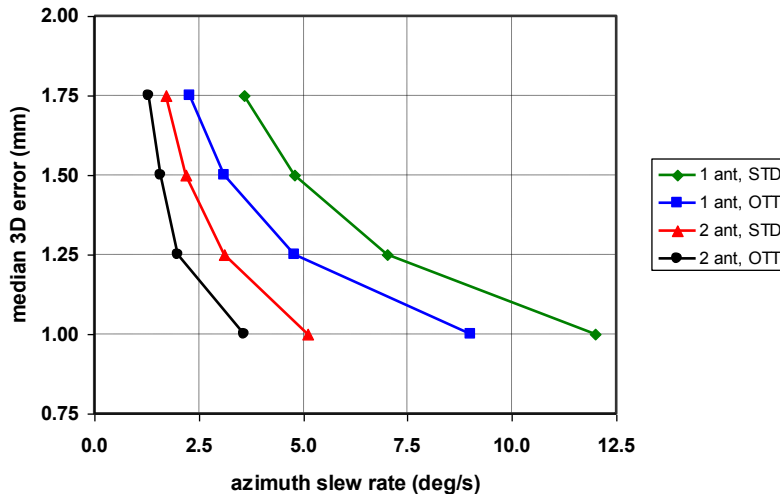

**Figure 3-3. Median of the rms 3D position errors vs. azimuth slew rate for either one or two antennas at a site and for both the STD and OTT mount types.**

While it is clear from this study that a single STD antenna with 12 deg/s azimuth slew rate will achieve 1-mm position error, other options can be considered such as a pair of antennas, each with significantly lower azimuth slew rate than 12°/s. For example, from Figure 3-3, a single STD antenna with 5°/s azimuth slew rate can be expected to achieve 1.5 mm 3D position accuracy. This is almost all of the improvement from current levels of performance to the 1 mm VLBI2010 target. At a later time, as the need increases or as funding becomes available, a second antenna could be added at a site to complete the improvement to 1 mm. If this approach is taken, a location for the second antenna should be set aside from the beginning.

### 3.3 Delay Measurement Error and the Broadband Delay Concept

The WG3 final report concluded that a delay measurement precision of 4 ps is required to achieve the VLBI2010 1-mm position accuracy target. This is nearly an order of magnitude improvement over current performance and cannot be achieved with existing dual-band S/X group delay systems ([Petrachenko, 2006](#)).

Fortunately, the development of data acquisition systems for astronomy with more than 10 GHz of instantaneous frequency coverage ([DeBoer et al., 2004](#); [US SKA Consortium, 2004](#)) has opened up the possibility, for geodetic VLBI, of using multiple, widely spaced frequency bands to resolve the very precise radio frequency (RF) phase delay with only modest SNR per band. This has been demonstrated theoretically ([Petrachenko, 2008a](#)) and allows the contemplation of systems that have excellent delay precision without the need for the high sensitivity that forces the use of large (and hence typically slowly moving) antennas. For an ideal operating environment with no RFI or source structure, it has been shown that a 4-band system (1 GHz per band) with RF frequency range 2–14 GHz can reliably resolve phase delay for SNRs as low as 10 per band and achieve delay precision of ~2 ps.

The delay derived using multiple widely spaced bands to resolve the phase delay has come to be known as the “broadband delay”. Since this approach is new, a proof-of-concept project has been initiated by NASA to test the idea experimentally and to gain experience with practical forerunners of VLBI2010 subsystems (cf. Section 5).

The implications of using the broadband delay for the VLBI2010 signal path are profound. They include the use of linearly polarized broadband feeds, broadband low-noise amplifiers (LNAs), fiber optic transmission of the RF signals from the antenna focus to the control room, an increase in the number of RF bands from two to four, and flexible frequency selection for each of the four RF bands (Section 4.1).

Known risks to implementing the broadband delay technique are related to radio source structure and RFI. It has been shown theoretically ([Niell, 2006b](#); [Niell, 2006c](#); [Rogers, 2006](#)) that the impact of even moderate source structure on interferometer output degrades the ability to connect phase between RF bands and ultimately to resolve the RF phase. RFI, on the other hand, restricts the use of regions of the 2–14 GHz broadband spectrum and hence limits the optimal definition of frequency sequences. Approaches for handling both risks are considered in more detail in Sections 3.7 and 3.4, respectively.

### 3.4 Radio Frequency Interference (RFI)

RFI is the man-made radio transmissions inadvertently added to the desired signal of interest from the target VLBI radio source. It can originate from fixed, mobile, marine, aeronautical, or space-based transmitters and for purposes ranging from commercial broadcast to scientific and amateur. In fact, the entire broadband VLBI2010 frequency range from 2 to 14 GHz is allocated for a myriad of applications through international, national, and regional agreements, with only a tiny portion set aside for radio astronomy. The broadband VLBI2010 receiving system must function in this somewhat hostile RFI environment, and it is expected that conditions will degrade over time through greater demand for the spectrum.

Fortunately, VLBI systems are comparatively robust against RFI. The large parabolic reflectors required to enhance the weak VLBI signals are also highly directional so that transmissions arriving from outside the main beam of the antenna are strongly attenuated relative to in-beam signals. In addition, due to the wide separation of VLBI antennas, the same interfering signal is rarely seen at both ends of a baseline and so do not correlate. Even when the same signal can be seen at both ends of the baseline (e.g., from geostationary satellites), it appears in the cross-

correlation at a different delay and fringe rate from those of the signal of interest and so does not affect the measured interferometric visibility.

For the case of moderate RFI arising from off-axis signals entering the antenna sidelobes, the primary impact is an increase in system temperature. In this case, the effect is isolated to the actual frequencies of the RFI. In the event that phase biases exist in the spectral region of the RFI, intermittent RFI will effectively modulate the biases and cause systematic variations in the measured delay ([Shaffer, 2000](#)).

For RFI that is strong enough to saturate the receiving system, the impact is much worse. At times when the RFI causes clipping, the VLBI signal disappears entirely, and the system sensitivity plummets across the full band, not just in the spectral region of the RFI. If the RFI is strong enough to cause clipping most of the time, a single narrowband interferer can effectively destroy the entire band. This situation must be avoided at all costs. To mitigate this problem, the dynamic range of the VLBI2010 receiving system from LNA to sampler needs to be high. In cases where the RFI is still too strong, band rejection filters need to be used prior to the point in the system where saturation occurs.

The implementation of a broadband receiving system for VLBI2010 introduces both advantages and disadvantages. On the one hand, it provides the freedom to shift selected bands to avoid RFI. On the other hand, it means that the full frequency range from 2 to 14 GHz must be received, making the system vulnerable to saturation if a large interferer is found anywhere in the range.

Efforts have begun to better understand the RFI environment. The NASA proof-of-concept project, with antennas outside large metropolitan areas (Boston and Washington, D.C.), provides a valuable test bed for evaluating the susceptibility of VLBI2010 systems to RFI. It is already clear that frequency selectivity below 2 GHz is required to avoid saturation from out-of-band TV signals.

In addition, searches of frequency allocation tables provide information about the RFI environment. Frequency ranges allocated for satellite TV broadcast (e.g., 3.7–4.2 GHz and 10.7–12.7 GHz), among others, have been identified as potential problems, but a more detailed analysis of the impact on the full VLBI2010 system is required to better assess the risk.

### 3.5 Frequencies

Throughout this document a number of VLBI2010 functions have been discussed that require access to specific regions of the radio spectrum. In this section all the frequency ranges are collected together and their purpose and limitations are considered ([Petrachenko, 2008e](#)). Due to practical considerations related to the antenna feed, it is unlikely that all can be implemented simultaneously.

- *Broadband (2–14 GHz)*. This is the most important frequency range for VLBI2010 since it enables the use of the broadband delay to improve delay precision by roughly an order of magnitude. It is likely that RFI will challenge the lower limit of this range and that, at least in the short term, technology will constrain the upper limit. For optimal VLBI2010 performance, illumination of the antenna by the feed should be independent of frequency and isotropic about the antenna axis, and the physical location of the feed phase center should also be independent of frequency. Broadband feeds are discussed further in Section 4.5.
- *S/X band (2.3 and 8.5 GHz)*. Current geodetic VLBI systems use a dual-band receiver with S band in the 2.2–2.4 GHz range and X band in the 8.2–8.95 GHz range. Although it is expected that existing antennas will eventually upgrade their feed/receiver systems to VLBI2010 specifications, interoperability with existing systems is necessary during the

period of transition to VLBI2010 operations. In addition, since source positions are frequency dependent, there is a strong requirement to continue access to S and X bands to maintain a connection with the current International Celestial Reference Frame (ICRF).

- *Water vapor band (18–26 GHz)*. The primary error source for geodetic VLBI is the wet atmosphere. One option for reducing its contribution is to measure the wet delay directly using a WVR ([Elgered et al., 1991](#); [Emardson et al., 1999](#)). Such instruments have been under development for many years, but, to date, none has shown convincing improvement for geodetic results, although they are valuable for meteorological studies. The addition of a coaxial 18–26 GHz feed and radiometer to the VLBI2010 receiving system would enable line-of-sight WVR measurements. This configuration would eliminate the low elevation and axis offset problems typical of current WVRs, but two current problems would remain: WVRs are unusable in the presence of rain, and the conversion from WVR brightness temperature to atmosphere delay needs detailed knowledge of the water vapor and temperature profiles along the line of sight.
- *Ka band (32 GHz)*. Due to RFI problems at S band, the NASA DSN is making a transition from S/X spacecraft tracking to X/Ka (8/32 GHz). To support this transition, an X/Ka celestial reference frame is being developed at JPL ([Jacobs et al., 2006b](#); [Jacobs and Sovers, 2008](#)). Because sources are generally more compact at Ka band, the X/Ka CRF is expected to be considerably more stable than the S/X. However, these benefits are somewhat offset by the fact that antenna and receiver design is more difficult at Ka band, sources are weaker, and atmospheric transparency and delay stability can degrade to the point that observations are impossible under some atmospheric conditions. Also, in many cases, reflectors of existing geodetic VLBI antennas have low efficiency at Ka band.
- *GNSS (1.1–1.6 GHz)*. There are two motivations for observing GNSS satellites with a VLBI antenna. One is to improve GNSS orbits by tracking satellites directly in the inertial frame defined by the ICRF. These observations could also serve as an additional method of inter-comparing VLBI and GNSS. The second motivation is to make differential measurements between the VLBI antenna and a small local directional GNSS antenna to establish gravitational and thermal models for the VLBI antenna and to establish and monitor intra-site ties.

### 3.6 Antenna Deformations

Antenna structures undergo both thermal and gravitational deformations. Both bias the effective position of the antenna. It is clear that the development of a stable, externally accessible set of reference marks is necessary for decoupling geophysically interesting site motions from intrinsic antenna deformations, for enabling comparisons and combinations of VLBI with other techniques, and for providing more general access to the VLBI frame.

- *Gravitational deformations*. Gravitational sag of the antenna reflector and feed support structure results in elevation-dependent delay variation and hence biases of the height estimates. Although measurements and calculations to determine gravitationally induced height bias continue to be refined (e.g., [Bolli et al., 2006](#)), they are complex, labor-intensive, and prone to error. One simple alternative is to construct antennas that are stiff with respect to gravitational deformation. This is easier to achieve for smaller antennas, which bodes well for the 12-m antennas proposed for VLBI2010.
- *Thermal deformations*. Thermal deformations can be classified as deformation of the antenna reflector (and feed support structure) and of the antenna tower. In the former case, the delay dependence is generally considered to be benign since it tends to be clock-like and hence can



be removed as part of the clock estimates. However, in the case of the antenna tower, thermal expansion and contraction cause the VLBI reference point to move up and down (and to a smaller extent side to side) and hence bias the station position estimate. For larger antennas, annual signatures can be in excess of 10 mm peak-to-peak and can clearly be seen in current data records. Three main approaches have been developed to measure or model the thermal deformations: the deformation is modeled based on antenna materials and simple physical models; the vertical deformation between a fixed point on the ground and the antenna intersection of axes is monitored using an invar wire; and the deformation is modeled using more complex analysis involving multiple temperature sensors and comparisons with invar wires. Another option is to build antennas out of materials with low coefficient of thermal expansion, such as composites based on Kevlar or carbon fiber. The smaller size of the VLBI2010 antenna reduces the amplitude of thermally induced deformations.

A final promising approach that has been suggested (Koyama, 2004; [Ichikawa et al., 2008](#)) is connected-element interferometry between a small (~2 m), structurally well-understood antenna and the primary VLBI2010 antenna. The purpose is to measure the baseline between the small stable antenna and the VLBI2010 antenna repeatedly and thereby to build and maintain thermal and gravitational models of the primary antenna. In a sense, this transfers the effective VLBI reference point to the intersection of axes of the small reference antenna. Due to its small size, it is expected that the reference antenna can more easily and accurately be connected to an external survey point. If the small antenna is also sensitive at GNSS frequencies as discussed in Section 3.5, it is conceivable that the intersection of axes of the small antenna could be connected directly to the effective IGS reference point. The simplicity, operational ease, and potential accuracy of this approach make it an attractive option.

### 3.7 Source Structure Corrections

The ideal radio source for reference frame definition is a point source with no apparent variation in position. Real sources, on the other hand, typically have structure that varies with both time and frequency. It is not uncommon that the structure of ICRF sources introduces tens of ps of group delay. These delay biases pose a risk both to resolving the broadband delay (Sections 3.3 and 7) and to achieving the VLBI2010 goal of 1-mm position accuracy.

In current geodetic VLBI practice, source structure effects have been mitigated by selecting sources that are known to have minimal structure. Although improved source lists have recently been compiled, many sources in the new catalogs still have enough structure to impair the ability to successfully resolve the broadband delay ([Niell, 2006b](#); [Niell, 2006c](#); [Rogers, 2006](#)).

Another strategy for dealing with source structure is to determine the structure from the geodetic data and correct for it. This has not been done routinely because current operational geodetic/astrometric schedules do not include enough observations of each source to create high quality images. The anticipated VLBI2010 operating modes resulting from larger networks, rapidly slewing antennas, higher data rates, and broadband operation will enable a significant increase in the number of observations per session, thus opening up the practical possibility of routinely generating source structure corrections from each operational geodetic/astrometric observing session.

Generating source structure corrections involves four steps:

- create an image of the source for each band of the VLBI2010 broadband system,
- use the images to generate source structure corrections at each observed u-v point,
- align the images in each of the bands relative to the highest frequency band,

- select a physical point in the highest frequency image to serve as the position reference for the source.

These steps are described in more detail in the Sections 3.7.1–3.7.4, including a discussion of the Monte Carlo simulations that have been performed to study the effectiveness of carrying out source structure corrections for the VLBI2010 systems.

### 3.7.1 Imaging Capabilities of the VLBI2010 System

In order to study the imaging capabilities of the VLBI2010 system, a processing pipeline that simulates the generation of VLBI images from VLBI2010 test schedules has been developed. Simulated VLBI images have been successfully produced for various schedules with different network configurations, numbers of observations per day, and observing strategies. Details concerning the pipeline and the initial results obtained in the case of high SNR sources are presented in [Collioud and Charlot \(2008\)](#). Additional simulations have been carried out for weaker sources (40 mJy) assuming a typical noise level equivalent to an SNR of 20. Results are presented in Figure 3-4.

The simulations demonstrate that the standard hypothetical 16-station network of the VLBI2010 system is in general well suited to producing high-quality images. However, this network fails to recover extended structures for far south sources due to the lack of short baselines in the southern hemisphere.

Tests were therefore carried out to determine whether adding two stations at carefully selected locations could help fill the central hole in the u-v plane and mitigate the southern hemisphere image reconstruction problem related to the lack of short baselines with just 16 stations. As shown in Figure 3-4, an 18-station network with two additional stations in the southern hemisphere clearly improves the recovery of extended structures, giving simulated images at southern declinations that have a quality comparable to northern sources.

### 3.7.2 Structure Corrections Based on VLBI2010 Images

The simulated VLBI2010 images may also be used to generate structure correction maps. These represent the effects of source structure on the broadband delay, or S/X synthesis delay, as a function of interferometer resolution. The structure correction maps also form the basis for the calculation of structure indices which characterize the astrometric suitability of the sources ([Fey and Charlot, 1997](#); [Fey and Charlot, 2000](#)).

Work is planned to assess the accuracy of the structural corrections derived from VLBI2010 images. For this purpose a sample of 100 similar VLBI2010 images has been produced using the same input source model but considering different errors in the simulated visibilities, generated using a Monte Carlo method. In a second step, the structure correction maps corresponding to these images will be derived and differenced with the theoretical structure correction map calculated from the “true” source model. From statistics of these differences, the accuracy of the corrections can be estimated. Such calculations will be repeated for different declinations and different source models. As noted above, inaccuracies in pinpointing the spatially invariant physical feature of the source should also be considered for a complete assessment of the error budget. Ultimately, these calculations should help determine whether the corrections are compatible with the 1-mm accuracy goal.

### 3.7.3 Relative Alignment of the Images in Different Bands

Since the maps generated in the first step lack information about their absolute positions, the images in the different bands need to be aligned relative to each other in order to properly combine

the data. Fortunately, the group and phase delays contain sufficient information to simultaneously resolve phase ambiguities and to align the map centers (Petrauchenko and Bérubé, 2007). The precision with which this can be done is dependent on the frequencies of the bands and the number of observations of the source. Petrauchenko and Bérubé (2007) conclude that relative map offsets can be reliably and accurately determined directly from VLBI2010-like data at an SNR of about 7 per band. This limit has been found under the assumption that the source is covered by at least 200 well-spaced scans within a 24-hour session. Using a somewhat different approach, Hobiger et al. (2008c) report even better performance.

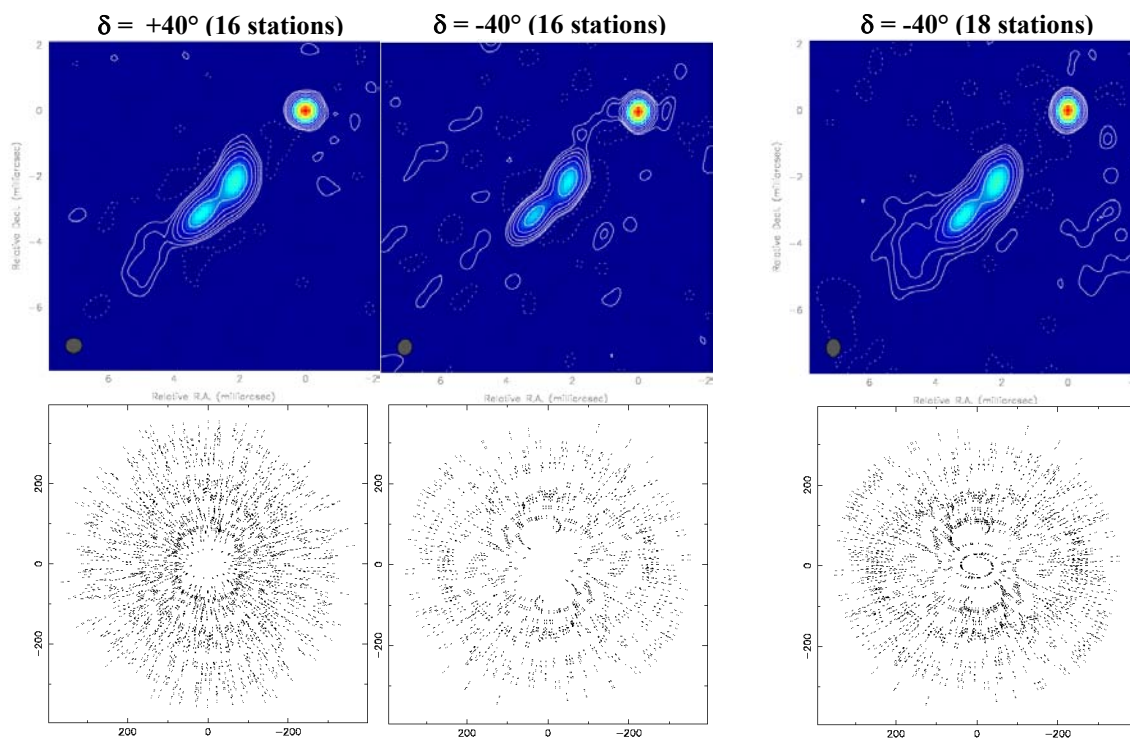

Source model

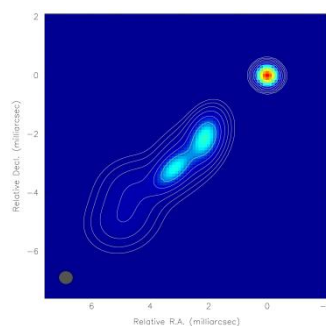

Figure 3-4:

Upper panels: Reconstructed VLBI images at declinations  $+40^\circ$  and  $-40^\circ$  for a typical VLBI2010 uniform schedule (60 s source-switching interval). The first contour corresponds to 0.05 mJy/beam (0.5% of the peak brightness) with successive contours increasing by a factor of two. The image on the right-hand side is that obtained when supplementing the usual 16-station network with two new stations. Middle panels:  $u$ - $v$  planes corresponding to the images immediately above them (in units of  $10^6 \lambda$ ). Lower left hand panel: The original source model convolved with a beam of 0.5 mas x 0.5 mas. The images in the upper panel can be compared to this source model. The total flux density is 40 mJy.

### 3.7.4 Identifying a Position Reference for the Source

A position reference point must be identified for each source. In the absence of structure corrections, this point is naturally placed at the centroid of the brightness distribution. Unfortunately, the centroid is typically not fixed over time or with observing frequency. Much better for geodesy/astrometry is to associate some feature of the map with a positionally invariant physical feature of the source, typically the black hole at its core. The problem is that the majority of radio emission from the source is generated by dynamic jets emanating from the core, but not the

core itself. Some success has been achieved by modeling the core-jet nature of the source as a point plus elliptical component ([Fomalont, 2006](#)).

## 4 System Description

Presented here is an overview of the current status of the V2C recommendations for the next generation system. Some recommendations, e.g., the antenna, are nearly complete, while others, e.g., the correlator, are at an early stage in their development. Not all major subsystems are discussed in detail, although all are at least mentioned here as part of the system overview. VLBI2010 recommendations for the network, station, and antenna are given in Sections 4.2–4.4. Some aspects of the feed, polarization processing, calibration, digital back end, and correlator subsystems are presented in Sections 4.5–4.10.

### 4.1 System Overview

Figure 4-1 is a block diagram of the VLBI2010 system. Its architecture, which differs significantly from that of existing geodetic VLBI systems, is driven by the needs for short source-switching intervals, improved delay measurement precision, smaller drifts of the electronics, and improved automation and operational efficiency. Of particular note is the change from a system with two fixed bands (S and X band) to a system with four bands, each of which can be placed anywhere in the 2–14 GHz range. The maximum VLBI2010 bit rate of 32 Gbps is based on the following assumptions: four bands, two polarizations, a Nyquist zone bandwidth of 1 GHz, 2 Gsample/s sample rate and 2 bits/sample. Technologically, many of the changes are enabled by continuing improvements in digital electronics. A suggested model for the VLBI2010 subsystem characteristics is summarized below.

- Antennas are relatively small ( $\geq 12$  m), fast slewing, and capable of mostly unattended operation (Section 4.4).
- Feeds are cryogenically cooled with dual linear polarization and continuous frequency coverage from 2 to 14 GHz (Section 4.5).
- Both linear polarizations are acquired, and all four polarization products are processed at the correlator (Section 4.6).
- The front end receiver is comparatively simple and includes
  - broadband LNAs for the two polarizations,
  - noise and pulse calibration subsystems, which inject signals into the receiver to calibrate the complex system gain down to the digitizer (Sections 4.7 and 4.8).
- The broadband (2–14 GHz) RF signals are transmitted directly from the receiver to the control room on fiber optic cables. This minimizes the number of signal cables between the receiver and control room and allows downstream analog processing, such as frequency translation and filtering, to be done under better controlled environmental conditions.

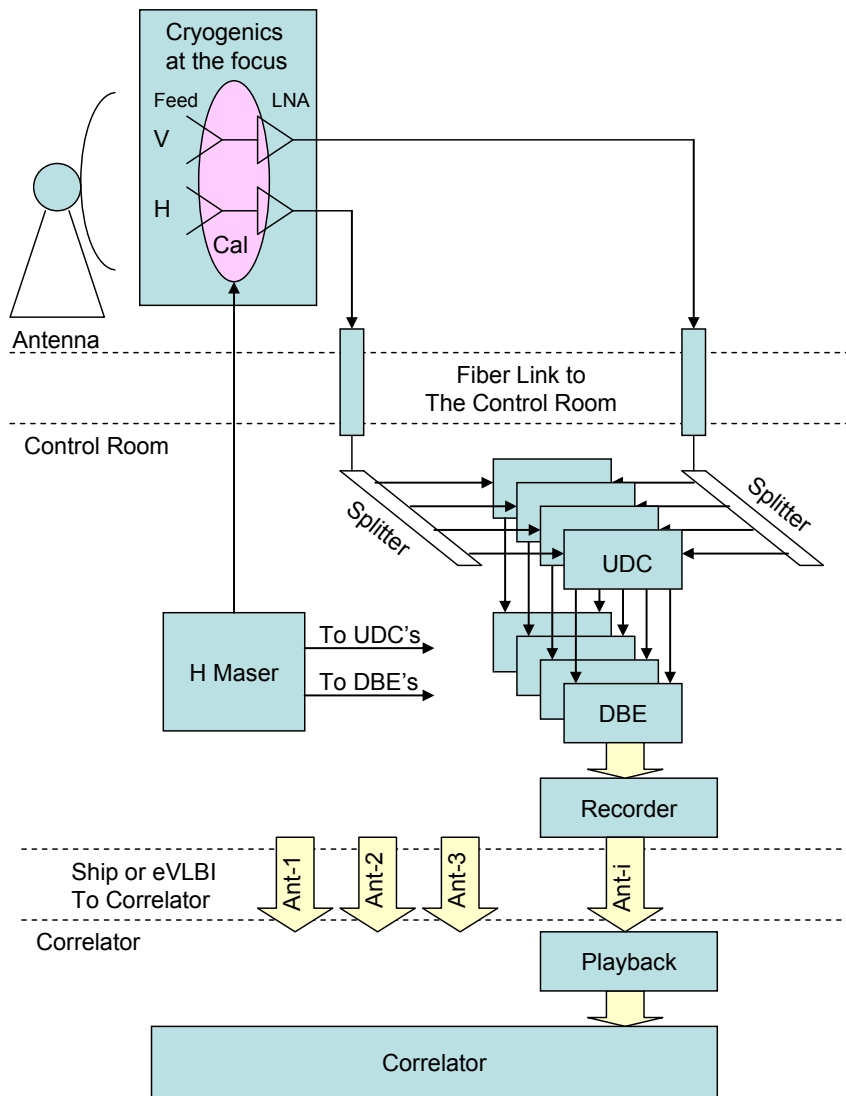

**Figure 4-1. VLBI2010 block diagram.**

- Four RF bands are processed, enabling the use of the broadband delay technique (Section 3.3).
- Each RF band is frequency-translated to the intermediate frequency (IF) range (0–3 GHz) in a flexible up-down converter (UDC). The translation is done in two mixing steps. The input is first shifted up in frequency with a programmable synthesizer to put the desired portion of the RF band in a predetermined, fixed frequency range. The signal then passes through a bandpass filter before being translated down to IF, where it can be digitized.
- The output of the UDC is sampled at 10 bits/sample and processed in the digital back end (DBE). Input signals initially pass through 1-GHz-wide anti-alias filters before sampling. Up to three Nyquist zones may be available. The sampled data are then processed in a field programmable gate array (FPGA), the primary functions of which are channelization, bit-truncation, and data quality analysis, including power level measurement and calibration signal detection (Section 4.9).

- A hydrogen maser provides the frequency and timing reference signals for the pulse calibration subsystem, the UDCs, and the DBEs.
- Data are stored, at least temporarily, on disk recorders.
- Recorded data are either shipped to the correlator on disk packs or, where possible, transmitted over optical fiber.
- Correlation is done in one or more software correlators (Section 4.10).

## 4.2 Network Recommendations

It is expected that increasing the number of VLBI stations and improving their global distribution will be beneficial for the three main product groups of the IVS: terrestrial reference frame (TRF), CRF, and EOP. The IVS WG3 final report recommends a VLBI2010 network of between 20 and 40 globally distributed stations, with the 20-station estimate based on roughly three sites per continent and the 40-station estimate based on a site spacing of approximately 2,000 km over all land masses.

For the TRF it is vital that the VLBI2010 scale be accurate and be transferred as effectively as possible to the International Terrestrial Reference Frame (ITRF). A robust transfer requires a large total number of VLBI sites co-located with the other techniques, GNSS, satellite laser ranging (SLR), and Doppler Orbitography and Radio-positioning Integrated by Satellite (DORIS) (along with improved site ties), while a more stable scale estimate itself requires more frequent observations with a larger network observing instantaneously. Although more frequent observations can be expected to improve results through averaging, dense time series of station positions will perhaps more importantly prove valuable for revealing, understanding, and eventually reducing systematic errors. While the primary emphasis in network design is on achieving a uniform global distribution of stations, the insensitivity of short baselines to EOP and to source structure errors makes regional site concentrations attractive as test beds for improving, for instance, atmosphere modeling and site ties.

For CRF a larger better-distributed global network improves u-v coverage, which is a prerequisite for generating higher quality images of radio sources, and also yields more uniform CRF quality between the northern and southern celestial hemispheres. In addition, a more uniform north-south distribution of stations leads to reduced coupling between global troposphere gradients and estimates of station latitude and source declination. Regional concentrations of stations will be needed to provide the short baselines for imaging the larger scale structure of the CRF sources. A larger global network, when coupled with the increased number of observations anticipated for VLBI2010, also opens the possibility of generating source structure corrections directly from the VLBI2010 data (Section 3.7); these corrections will benefit all of the IVS data products. Although not necessarily required on a daily basis, a subset of larger antennas will allow detection of weaker CRF sources.

For EOP it is necessary that the VLBI2010 estimates be strongly coupled to the ITRF. Experience has shown that EOP estimates from current VLBI networks show biases relative to each other and that those biases change with time. The systematic impact of any single station on VLBI EOP determinations can be expected to become smaller as the network size increases, making a larger network more robust against changes in network composition. At least a subset of the antennas needs high speed data links to the correlator to allow near-real-time (< 24 hours) EOP delivery.

The VLBI2010 network also needs to be considered in the context of other space geodetic techniques. Due to the small numbers of VLBI and SLR sites, established and planned SLR sites

should be considered as potential locations for new VLBI2010 antennas. This anticipates the demand for all-technique sites for GGOS 2020 ([GGOS, 2009](#)).

All V2C simulations have shown that a global 16-station network observing simultaneously can achieve the performance goals of VLBI2010. However, based on the considerations given above and due to time necessary for maintenance and repair, the following recommendations are made for the minimum VLBI2010 network.

- Have at least three regularly observing stations on each major tectonic plate, with more encouraged in regions where economics allow.
- Have at least eight regularly observing stations in the southern hemisphere.
- Have at least six regularly observing, globally distributed stations with high data rate connection to one or more correlators to enable near-real-time EOP delivery.
- Have at least eight larger ( $\geq 20$  m) antennas (four per hemisphere) for CRF densification.
- Wherever possible, co-locate new VLBI2010 stations near existing or planned space geodesy observatories, with a priority to SLR sites.
- Have a capability to process continuous observations for at least 24 stations, with a long-term goal to increase the number to at least 32 stations.

### 4.3 Station Recommendations

In order to establish a high quality VLBI2010 station, criteria are required for site selection, for local surveys, and for instrumentation ([Malkin, 2008a](#)).

Once the general location of a site has been determined based on network considerations, it is recommended that the following criteria be applied for site selection.

- The site should be geologically stable, i.e. located on firm, stable material, preferably basement outcrop, with small groundwater fluctuations. In regions where this is impossible, particular attention should be given to the stability of the antenna foundation and a robust tie to a well-designed regional footprint should be developed.
- The site should be free of existing and forecastable obstructions above  $5^\circ$  for at least 95% of the horizon.
- The site should have a minimum of RFI from existing and forecastable local transmitters. Over the longer term, contacts with local regulators should be developed to ensure that the RFI environment does not degrade significantly.
- The site should be co-located with other space geodesy techniques (GNSS, SLR, DORIS, and gravimetry), preferably with long observational histories. For sites where other techniques may be introduced in the future, site criteria for those techniques should also be taken into account.
- The site should include space for a second VLBI2010 antenna if possible.
- The site should be near an existing or planned high-speed data link with a long-term goal of a data transmission rate of at least 4 Gbps. Where not possible, access to expedient shipping is required.
- The site should be connected to regional/national geodetic networks.

- The site should be developed in coordination with IVS, IAG/GGOS, and IAU directing bodies.
- The site should be secure and have access to power, transportation, and personnel.

Local geodetic networks are needed to monitor the stability of the VLBI reference point. The local network should consist of a station network and a regional footprint network. The accuracy of the surveys should be significantly better than 1 mm, and all survey data should be rigorously reduced to provide 3D geocentric coordinate differences in the ITRF system.

The station network should meet the following criteria:

- There should be at least three ground monuments around each VLBI antenna at a distance of 30–60 m (up to 100 m for large antennas).
- Visibility from these monuments to the other space geodetic techniques should be provided.
- The monument design should correspond to the local geological conditions and provide maximum stability over time.
- The local network should be surveyed at least as often as once every 2.5 years, in summer and winter seasons alternately. More frequent surveys, once every six months, should be performed during the first two years after installation of new instrumentation or monuments.
- Measurements of the temperature-adjusted VLBI antenna reference points and axis offsets should be included in the survey. This requires a clear definition of the reference temperature ([Böhm et al., 2008](#), [Heinkelmann et al., 2008](#)).

The footprint network should meet the following criteria:

- At least three ground monuments should be located around the site at a distance of 10–30 km from the station.
- The network should be surveyed at least once every five years, with annual surveys for the first two years after the installation of the network.

A VLBI2010 station must be equipped with the following systems:

- an antenna designed and equipped in accordance with the VLBI2010 system specifications,
- a GNSS receiver that meets the IGS requirements and is connected to the station frequency standard,
- an eight-hour uninterruptible power supply (battery plus generator) to handle all system functions including antenna movement,
- rooms and equipment for station maintenance and repair,
- local geodetic network,
- a meteorological system:
  - The meteorological station must provide automated digital measurements of the following parameters with the respective minimum accuracies:
    - temperature                      0.5°C,
    - pressure                              0.5 hPa,





2–14 GHz required.

*Aperture efficiency:* > 50%

*System temperature:* < 40 K excluding atmospheric contribution.

*Optics:* not yet specified—as required to give maximum sensitivity with the feed.

*Slew rates and accelerations:* see Section 3.2 for specifications for a single or pair of az-el antennas.

*Blind pointing accuracy:* < 0.1 HPBW (half-power beamwidth) at 32 GHz (equivalent to < 20 arcsec for a 12-m dish) for primary operating conditions; < 0.3 HPBW at 32 GHz (equivalent to < 1 arcmin for a 12-m dish) for secondary operating conditions. These limits apply both to pointing to an arbitrary position on the sky and to tracking at a specified rate.

*Settling time:* < 1 second from 1°/s slew rate to specified pointing accuracy.

*Encoder angular resolution:* < 10% of the required pointing accuracy.

*Primary operating conditions:*

temperature: 10-year minimum to 10-year maximum

rel. humidity: 0–100% with condensation

wind speed: < 40 km/hr sustained (or < 98-percentile wind speed, if higher)

rainfall: < 50 mm/hr

*Secondary operating conditions:*

temperature: 10-year minimum  $-5^{\circ}\text{C}$  to 10-year maximum  $+5^{\circ}\text{C}$

rel. humidity: 0–100% with condensation

wind speed: < 80 km/hr sustained (or < 99.5-percentile wind speed, if higher)

rainfall: < 100 mm/hr

*Survival conditions at stow with negligible structural damage:*

temperature: 100-year minimum  $-5^{\circ}\text{C}$  to 100-year maximum  $+5^{\circ}\text{C}$

rel. humidity: 0–100% with condensation

wind speed: < 200 km/hr sustained

rainfall: < 100 mm/hr

hail: < 20-mm-diameter hailstones with < 50 km/hr wind

ice: < 30 mm thick on all exposed surfaces

seismic: < 0.3 g, horizontal and vertical

corrosion: can withstand coastal environment

*Reference point definition:* The geodetic reference point, or “invariant point”, is the intersection point between the fixed rotation axis and the plane that contains the moving axis and is perpendicular to the fixed axis. For an elevation-over-azimuth mount, the fixed and moving axes are the azimuth and elevation axes, respectively. If the offset between the rotation axes is zero, the reference point is the point where the axes intersect.

*Reference point stability:* Relative to a local geodetic network external to the antenna and its foundation, the 3-dimensional position of the reference point must be either stable or modelable, as a function of elevation and temperature (and possibly other parameters), to less than 0.3 mm rms.

*Path length stability:* Define the path length difference to be the difference between the arrival times (converted to length by multiplying by the speed of light) of a plane wavefront at the reference point and at the feed after passing through the antenna optics. The path length difference must be stable or modelable, as a function of elevation and temperature, to less than 0.3 mm rms for all pointing directions under primary operating conditions. Provision should be made to mount geodetic instrumentation, such as reflectors or corner cubes, on the antenna primary and secondary reflectors and around the feed to allow measurements of path length variations for different pointing directions.

*Maintenance:* Mount, drives, and antenna structure should be able to withstand nearly continuous operation with more than 2,500 long slews per day. Antenna mechanical structure aside from motors and gear boxes should have a lifetime of more than 20 years. MTBF (Mean Time Between Failures) for motors and gear boxes should be larger than 2 years. Replacement and maintenance of motors and gear boxes should be convenient and inexpensive. Projected downtime for repair and maintenance of antenna and drives should be less than 10 days per year. Projected cost of annual maintenance of antenna and drives should be less than 10% of antenna capital cost.

Recommendations on antenna control and cable wrap are given in [Himwich and Corey \(2009\)](#).

#### 4.5 Antenna Feed

In order to maintain high aperture efficiency over 2–14 GHz, the beamwidth and phase center location of the VLBI2010 feed need to be nearly independent of frequency, and the polarization purity must be good. No circular polarization feed with these properties is known to exist or to be under development. The VLBI2010 feed will therefore be a dual linear polarization feed.

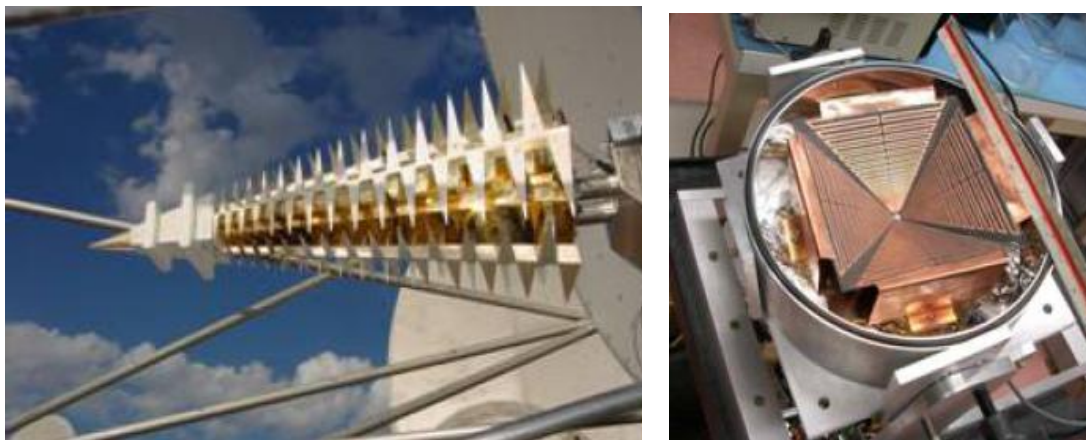

**Figure 4-2. Left: ATA feed installed on an ATA dish. Right: Prototype Eleven feed in a cryogenic dewar.**

Several feeds with beam patterns and phase centers that vary little with wavelength are in various stages of development. Among them are the so-called Eleven feed (Figure 4-2), which is a log-periodic, folded-dipole feed (Chalmers), a quasi-self-complementary feed (Cornell), and an inverted conical sinuous feed (NRAO). All of these are compact and can be installed and cooled to cryogenic temperatures inside a dewar ([Imbriale et al., 2007](#)). None of these feeds has progressed past the prototype stage, and there are still significant technical issues to be resolved, including how to maintain mechanical integrity when cooled to cryogenic temperatures, how to integrate the LNA with the feed structure, and how high the frequency range can be pushed with satisfactory performance. The V2C is monitoring these developments closely.

The dual-polarization ETS-Lindgren feed being used in the proof-of-concept tests (Section 5) is a fallback candidate for VLBI2010. Its advantage is that it is available commercially now. Its disadvantages include strong wavelength dependence and asymmetry of the beam patterns with significant cross-polarization, all of which impact aperture efficiency. Tests at JPL ([Imbriale et al., 2007](#)) have shown that putting the feed inside a cylinder (such as a dewar), and adding absorber either to the interior cylinder walls or to the feed itself, improves the beam patterns. The second fallback candidate is the log-periodic pyramidal Allen Telescope Array (ATA) feed. Its design is mature, and feeds have been installed on 42 ATA antennas (Figure 4-2). A drawback of the ATA

design is frequency dependence of the phase center location along the feed axis, with attendant frequency-dependent efficiency losses when observing over a wide frequency range.

#### 4.6 Polarization

The VLBI2010 antenna feed will be sensitive to linear polarization instead of the traditional circular polarization of most current VLBI feeds (Section 4.5). A disadvantage of linear feeds in VLBI is the sinusoidal dependence of the fringe amplitude on the varying feed angle difference between antennas: as the Earth rotates, the orientation of a feed on an az-el or x-y mount changes with respect to the radio source, and for two widely separated antennas, the difference in feed angles can be  $90^\circ$ , with a corresponding null in fringe visibility. This problem can be avoided by employing dual-polarization feeds. An alternative is to rotate single-polarization feeds axially so that all feeds in a VLBI network maintain the same orientation on the sky. The operational feasibility of this approach is yet to be ascertained.

While no one has yet found a way to build a good broadband circular feed, it is possible to construct a circular signal from the two linear signals after digitization. This could be done in the DBE by applying a  $90^\circ$  phase shift to one signal and then adding it to the other. Or it could be done after correlation if all four cross products between the two linear signals are processed ([Corey, 2007](#)).

A complication of constructing a circular signal after the feed, whether at the station or at the correlator, is the inevitable differences in the analog instrumental gain and phase for the two polarization channels after the feed. For instance, if the gain for one polarization is much higher than for the other, the signal created by phase-shifting and summing the two will be dominated by the high-gain channel and so will effectively remain a linearly polarized signal. The relative gains and phases between the two channels must therefore be measured, and their effects corrected for prior to constructing the circular signal. There are several options for carrying out the measurements, ranging from observations of carefully selected radio sources to the use of phase/noise calibration methods, or combinations thereof.

#### 4.7 Phase and Cable Calibration

The primary purpose of the phase calibration system is to measure the instrumental phase/delay response. For most applications only temporal variations are of interest, but for a few critical applications, such as UT1 measurement and time transfer, knowledge of the absolute delays is also required. For VLBI2010, the specification on the instrumental delay measurement error has been set to  $< 1$  ps, so that it is well below the single-observation stochastic error, which is targeted to be 4 ps.

In current geodetic VLBI systems, instrumental delays are measured using a pulse calibration system. A spectrally pure 5 or 500 MHz signal is transmitted by cable to the receiver, where it triggers a tunnel diode to generate pulses with very fast ( $\sim 30$  ps) rise times. The pulses are injected into the signal path prior to the first LNA and accompany the signal through to digitization, after which the phases of the tones are extracted.

A similar system is envisioned for the VLBI2010 system. Commercial sources for tunnel diodes have become scarce, however, and the long-term availability of diodes is a serious concern. Alternative designs for pulse generators employing high-speed digital logic gates and/or comparators are under development, and results obtained with prototypes are extremely encouraging (e.g., [Rogers, 2008](#)). The physical location of the pulse generator could be either on the antenna, with the reference signal carried to it over coax or fiber, or in the control room, with the RF pulses sent to the antenna over fiber.

The phase cal injection point may be between the feed and LNA, as in current S/X systems, or it could be moved ahead of the feed or immediately after the LNA. These options are being investigated with the NASA proof-of-concept system (Section 5). Injecting phase cal ahead of the feed has the advantage of putting more of the VLBI signal path in the calibration loop, but multipath may be a problem. All three options include in the calibration those system components with the largest phase variations: long cables subject to varying temperature or mechanical stress (as in an antenna cable wrap) and high-frequency local oscillators (LOs), which are prone to be temperature-sensitive.

Two options for the means of extracting the phase and amplitude of the calibration tones are under consideration. Both could be implemented in the DBE or at the correlator.

- If the RF phase cal and total LO frequencies ahead of the detection point are integral multiples of 5 MHz, say, then the phase cal signal will repeat every 200 ns, and the sampled data can be binned and averaged over a 200-ns interval. The FFT of the averaged signal then yields the amplitude and phase of each phase cal tone.
- Should the above conditions on the frequencies not hold, the phase cal information can be extracted using standard, dedicated tone detectors of the type employed in many geodetic acquisition systems (e.g., Mark IV, VLBA, S2) and correlators.

If the electrical path length between the maser and the pulse cal injection point varies excessively, it must be measured, and its effect on the extracted phases subtracted. The precision of the current Mark IV cable measurement system is inadequate for VLBI2010 on time scales under a few minutes. Other designs with the requisite sub-picosecond precision have been developed for geodetic and astronomical applications and could be adopted, with modification, for VLBI2010. It is possible, however, that a cable system may not be necessary if optical fiber or coax cables with low temperature and mechanical stress sensitivities are selected, and if the antenna cable wrap imparts low stress on the cables.

#### **4.8 Noise Calibration**

In addition to the new pulse calibration system, a new noise calibration system is also planned. As in current systems, it will be based on a calibrated noise diode, but in the new version it will use the 80 Hz synchronous detection process that has become standard in radio astronomy. An upgraded noise calibration system is essential to support the source structure corrections contemplated for VLBI2010 (Section 3.7). As with the pulse calibration system, the injection point for the calibration signal remains an open question.

#### **4.9 Digital Back End (DBE) Functions**

Traditionally, a VLBI back end uses primarily analog electronics. However, due to advances in digital electronics, it is now cost effective to sample the IF signal directly and do sub-band processing digitally. This approach has been under development for several years and is now about to be deployed in mainstream geodetic VLBI systems. Two options exist. Either the digital processing completely replaces current analog baseband converters (BBC), one digital algorithm per effective BBC, or a polyphase filter plus fast Fourier transform (PPF&FFT) is used, with all output channels available simultaneously, albeit with restrictions relating to the customizing of sub-band frequencies and bandwidths. The latter option, which is very cost effective, is favored for VLBI2010.

This section discusses important functions to be considered for inclusion in the VLBI2010 DBE ([Petrachenko, 2008d](#)).

- *Anti-alias filter.* To handle the proposed VLBI2010 1-GHz bandwidth, the DBE anti-alias filters should be 1024 MHz wide. Whether the first, second, or higher Nyquist zone is used will depend on the details of the preceding down-conversion system and the bandwidth of the sampler.
- *Sampler.* The sampler clock frequency should be 2048 MHz, or a harmonic thereof. The sampler bandwidth should be as large as possible in order to maximize the number of available Nyquist zones. In addition, since the VLBI signals will be re-quantized to 1 or 2 bits after the PPF&FFT (see next item), it is necessary that the sampler resolution be significantly greater than that to avoid second-quantization loss. In the absence of RFI a practical sampler resolution might be 4 bits, with each additional bit providing 6 dB of headroom for RFI. At least 8 (and preferably 10) bits of resolution are recommended for the VLBI2010 sampler.
- *PPF&FFT.* The main parameter to specify for the PPF&FFT is the sub-band bandwidth. For numerical efficiency of the FFT it must be a power-of-two sub-multiple of the sample clock frequency. For efficient RFI excision and thorough spectral monitoring, narrow sub-bands are better. Although the final decision is somewhat arbitrary and may depend on downstream computations, sub-band bandwidths as low as 1 MHz are not out of the question.
- *Polarization conversion.* Although polarization processing may best be done after correlation, another option is to convert linear polarization digitally to circular polarization in the DBE (Section 4.6).
- *Re-quantizer.* For efficient transmission to the correlator, the PPF&FFT output needs to be re-quantized to 1 or 2 bits. For optimal 2-bit data the voltage magnitude threshold should be set near 1 sigma. Since performance varies slowly with threshold, wired thresholds may be adequate under many circumstances. However, the use of sub-band-specific thresholds will be more robust under suboptimal conditions and should be implemented if possible. Threshold values can be determined from sub-band power monitoring or from stream statistics (see below).
- *Corner turner.* For each output clock cycle of the PPF&FFT, data are grouped naturally as a set of complex data points, one pair per sub-band. However, distribution to correlation resources is done most efficiently if the data are re-grouped into continuous streams for each sub-band. This is referred to as corner turning and is efficiently implemented in the DBE.
- *Sub-band selection.* Not all sub-bands will necessarily be transmitted to the correlator. Sub-band selection should be flexible to allow adaptation to, e.g., changing band optimization schemes and RFI environment.
- *Burst acquisition.* In order to minimize on-source time, data need to be acquired at a rate as high as possible. These bursts of data should be buffered so they can be transmitted at a rate matched to the storage media while the antenna is slewing to the next source. The DBE may be a convenient location for the buffering.
- *Data quality analyzer (DQA) and calibration.* Different DQA and calibration functions are performed most naturally at different points in the signal processing path, e.g., prior to PPF&FFT, between PPF&FFT and re-quantization, or after re-quantization. The most important functions are:

- *Phase cal detection.* Phase cal detection can be implemented in the DBE or at the correlator (Section 4.7). Since it provides an accurate indication of end-to-end system coherence, which must be achieved for successful correlation, it is an invaluable diagnostic at the station. At least some phase cal detection capability is essential at the station.
- *Full-band power monitoring.* Power detection of the input signal is required both for radiometry and for setting the sampler input power to near an optimal level. Since the front end noise diode will be switched on and off rapidly (perhaps at 80 Hz), power levels must be detected synchronously with the on/off signal.
- *Sub-band power monitoring.* Sub-band power monitoring will be used to assist in setting the sub-band bit-truncation levels and to monitor RFI. This monitoring must be done after the PPF&FFT on each sub-band, synchronously with the noise diode on/off signal.
- *Time-binned power monitoring.* To gain information about pulsed RFI, it may be desirable in some cases to bin power measurements into higher resolution time increments.
- *PPF&FFT.* If additional spectral information is required, a second level PPF&FFT can be applied on a selected sub-band basis.
- *Stream statistics.* After the re-quantizer, the number of data points in each re-quantized state is counted.

#### **4.10 Correlator**

Possibilities for a VLBI2010 correlator include a full custom hardware correlator, an adaptation of an existing hardware correlator, a software correlator, and a hybrid correlator, wherein FPGAs perform the most compute-intensive functions and software does the rest. All have their merits, either for a transition period or for the long term, although a full custom correlator is probably a poor choice, given its long development time and the availability of other options. The flexibility and ease of implementation of a software correlator make it the preferred option (e.g., [Deller et al., 2007](#)).

In its initial operation VLBI2010 will probably involve no more than 24 stations and a sustained data rate of 4 Gbps. A preliminary estimate of requirements for a VLBI2010 software correlator indicates that this is in fact a viable option (Briskin, 2008).

## **5 NASA Proof-of-Concept Demonstration**

### **5.1 Description of the NASA Broadband Delay Proof-of-Concept System**

A key new element of VLBI2010 is the broadband delay (Section 3.3). In order to demonstrate that the concept is feasible, all of the components of the broadband delay system have been implemented on two antennas, the 18-m antenna at the Haystack Observatory in Westford, Massachusetts, and the 5-m MV-3 antenna at the NASA Goddard Space Flight Center in Maryland, a baseline of 597 km. The combined effective collecting area of these two antennas is somewhat less than that of two 12-m antennas but should be sufficient to validate the concept.

To receive the multiple bands required by the broadband delay technique, the proof-of-concept system uses a feed that covers the range  $\sim 2$  GHz to  $\sim 14$  GHz in two linear polarizations. The feed for the initial tests is the ETS-Lindgren Model 3164-05, a commercial wideband feed. This feed was chosen because it is readily available and relatively inexpensive. It is known that the particular combinations of the commercial wideband feed and the optics of both MV-3, which is Cassegrain, and Westford, which is used in a prime focus configuration, are far from optimum. To eliminate unacceptable ohmic losses at higher frequencies, the feed is cooled to approximately 20 K in a cryogenic dewar (Imbriale et al., 2007). See Figure 5-1 for an overview of the full system.

Following the feed in the dewar are, for each polarization, a high-pass filter, a directional coupler,

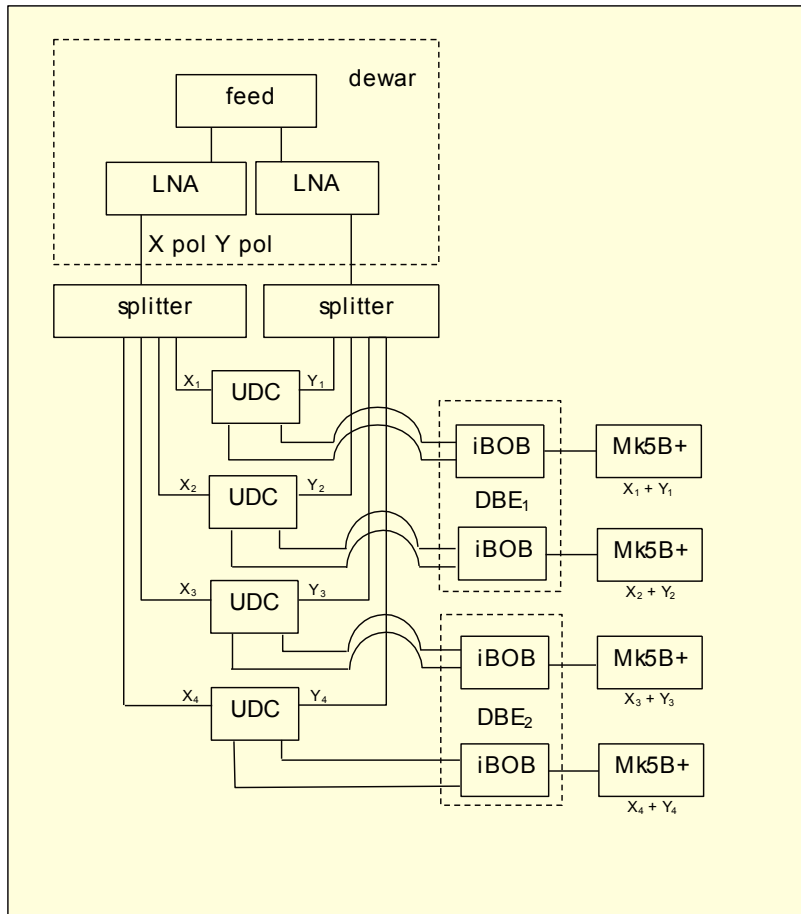

**Figure 5-1. Diagram of the main components of the broadband delay data acquisition chains from feed through data recorder. The Dewar containing the feed and LNAs is mounted on the antenna. The components from the splitters down are located in the control room.**

and a low noise amplifier. As part of the VLBI2010 effort a new phase calibration generator has been developed that relies on digital components, rather than the tunnel diode used for the Mark IV version (Rogers, 2008). The output is injected through the directional coupler in each path. The rail spacing is currently 5 MHz, although 10 MHz spacing is also being considered. Injection of a noise diode signal for amplitude calibration is planned.

The RF signal for each polarization is carried from the dewar to the control room on a separate optical fiber. In the control room, following the optical fiber receiver, each RF polarization channel is divided into four branches. The two polarizations from each band are then processed through the UDC, DBE, and recorder as a pair.



The UDC utilizes a common oscillator for two channels, one for each polarization of a band. This reduces phase differences between the polarizations as well as cost. The IF filter for each channel is 2 GHz wide. It is possible to output the signals for two Nyquist zones (NZ) in both channels of the UDC with independent programmable total gain for each of the four channels. For the broadband system demonstration, only one Nyquist zone for each polarization is selected after down-conversion and passed to the DBE. To match the current capability of the DBE, the NZ filters are 512 MHz wide.

The bandwidth-limited signals from both polarizations of one band are input to a two-channel, eight-bit analog-to-digital converter (ADC) in the DBE. The sampled data are passed to the [iBOB](http://casper.berkeley.edu/wiki/index.php/IBOB) (interconnect break-out board; <http://casper.berkeley.edu/wiki/index.php/IBOB>) containing the FPGA chip which, for this application, outputs sixteen two-bit 32-MHz-wide channels for each polarization. The iBOB is a product of the Center for Astronomy Signal Processing and Electronics Research group at UC Berkeley, and the DBE is a joint development of that group and MIT Haystack Observatory. In order to keep the number of recorders to four at each site, the eight odd-numbered 32-MHz channels from each polarization are combined on one of the two VLBI standard interface ([VSI](http://www.haystack.mit.edu/tech/vlbi/vsi/index.html), <http://www.haystack.mit.edu/tech/vlbi/vsi/index.html>) outputs from the iBOB for a data rate to each Mark 5B+ recorder of  $\sim 2$  Gbps. With four recorders the total data rate is  $\sim 8$  Gbps at each site. The rate for each polarization of each band is  $\sim 1$  Gbps.

## 5.2 Results and Current Status

Several tests have been conducted with the broadband systems. In the first group of tests, only MV-3 had the broadband VLBI2010 system, while Westford used the standard circularly polarized S/X feed, amplifier, and local oscillator, but with its X-band output split eight ways and fed directly to the DBEs. All four bands at both antennas were set to record the same X-band frequency range,  $\sim 8.6$ - $9.1$  GHz. The primary purpose of the initial tests was to demonstrate the functionality of the broadband system. However, the mixed broadband and S/X operating mode is also of interest since it will be required during the transition to VLBI2010 operations when networks include some antennas with standard S/X capability while others are equipped with broadband systems.

For this first group of tests, most of the broadband components of the proposed VLBI2010 system were mounted on MV-3. However, there was no phase cal at that time, and one channel was carried on coaxial cable instead of optical fiber. Linear polarization was recorded at MV-3 and circular at Westford. First fringes were found Nov 19, 2007, and a six-hour observation of the source 3C84 was made on Jan 4, 2008. From these sessions and the preceding single antenna measurements, several things were learned. a) Television signals near 520 MHz can saturate the LNAs and may be strong enough to damage them. b) The efficiency of MV-3 at X-band is about one-third the expected value. c) The VLBI fringe amplitudes and the SNRs agree within 10% with the values expected from the single dish measurements at each site. A temporal variation in phase difference between the two polarizations at MV-3 was found, but without phase cal the cause could not be isolated. The most likely cause was different responses of the optical fiber and the coax cable to temperature change.

Having verified functional operation during the initial tests, a dewar and set of UDCs were replicated for Westford. VLBI observations were then carried out with VLBI2010 systems at both sites, now also including phase cal and optical fiber for both polarizations. It was found that Westford is also severely affected by the TV signals, and concern was raised that the LNAs might be damaged, not just by the TV but by a nearby radar at 1.295 GHz. A decision was made to install protective diodes in the LNAs and high-pass filters were installed in the dewars at the outputs of the feeds. Although a low frequency cutoff of 3.1 GHz is currently being used for the high-pass

filters, a better filter with a frequency cutoff low enough to allow S-band observations will be included at a later stage of development.

Currently the phase cal signal is generated by a Mark IV unit that was modified to produce a tone spacing of 5 MHz. Initially the signal was injected through a probe mounted just in front of the dewar window, but, because of concern about the stability and balance of power between the polarizations, the signal is now split and injected through directional couplers (one for each polarization channel) following the filters inside the dewar.

The UDCs allow a great deal of flexibility in the choice of frequency for each band, so observations have been made in several modes to evaluate the internal consistency of the four UDC/DBE/Mark-5B+ channels and to sample the response over much of the RF range that is accessible. Fringes have been detected from  $\sim 3.4$  GHz to  $\sim 9$  GHz, but at the time of writing the phase characteristics have not yet been analyzed.

As noted above, the sensitivity of MV-3 was found to be only about one-third the expected value when the dewar was installed. Attempts to improve the efficiency by determining an optimum focus setting have not been successful. Measurements of the shape of the primary surface and the sub-reflector show that the sub-reflector is not correct for the paraboloidal main reflector. It is unclear if the low efficiency is due to the mismatched sub-reflector, to improper illumination of the sub-reflector by the Lindgren feed, to both, or to other problems. At Westford the sensitivity was improved in a band near 4 GHz by adjusting the focus based on observations of a satellite, but this appears to have reduced the sensitivity at higher frequencies. Maximizing the sensitivity for the systems as they currently exist, for example by finding the best focus settings, is a high priority. Whether major modifications, such as changing the sub-reflector at MV-3, will be made will require additional modeling and measurements of the beam pattern of the dewar/feed combination.

### 5.3 Plans

The next steps will include installing the new phase calibrator, improving our understanding of the requirements of the operating parameters for the DBE, maximizing the sensitivities of the antennas, obtaining observations spanning the full available frequency range, and developing optimum analysis procedures for estimating the delay for the dual linear-polarization observations.

The main component that requires further development for the prototype demonstration is the broadband feed. The commercial version being used for these demonstrations is not matched to the antenna geometry, and both the beamwidth and the phase center are frequency dependent. As soon as a candidate is available, it will be installed on one of the two antennas for evaluation.

For the anticipated operational VLBI2010 system the second generation of DBE and recorder are under development. The DBE2 will have significant additional capability and functionality, including phase cal and noise cal extraction for better phase and amplitude calibration. The DBE2 and Mark 5C ([Whitney, 2008](#)) recorder will transfer data via 10 Gbps Ethernet, allowing 4 Gbps recording on one Mark 5C. These components will be utilized in the broadband demonstrations as they become available.

## 6 Operational Considerations

In this section issues related to VLBI2010 operations are considered. The operational challenges of meeting the VLBI2010 requirements for continuous observations, latency of less than 24 hours to initial geodetic products, and a manifold increase in data volume are given particular attention.

Section 6.1 outlines an observing strategy to meet the needs of VLBI2010, and Section 6.2 summarizes how the transition from current operations to VLBI2010 can be effected. Sections 6.3

and 6.4 discuss automation in data acquisition and analysis, Section 6.5 introduces the IVS Working Group 4 effort to modernize VLBI data structures, and Sections 6.6 and 6.7 treat data transmission from the antennas to the correlator.

## 6.1 Observing Strategy

An observing strategy for VLBI2010 must:

- yield TRF, CRF, and EOP data products of the requisite quality,
- fulfill the VLBI2010 requirements for continuous observations and latency of less than 24 hours to initial geodetic products,
- allow for station maintenance and repair,
- allow for research and development (R&D),
- be affordable and sustainable,
- enable an integrated use of legacy and special purpose antennas with VLBI2010 antennas.

At the heart of the observing strategy for VLBI2010 are the acquisition, correlation, and reduction of data from a globally distributed subset of 16 VLBI2010-compliant stations to produce continuous, high-quality EOP ([Petrachenko, 2007](#)). A smaller number of these antennas must have access to a cost-effective high-speed fiber optic network to meet the VLBI2010 requirement for less than 24 hour turnaround time from observations to initial geodetic products. The antennas that are not observing are available for station maintenance and, if necessary, repair. In general, each station strives for as continuous a data set as possible in order to better understand and reduce systematic effects that limit accuracy.

The key to extending these observations to enhance CRF and TRF, and to provide opportunity for R&D is the development of a correlator capacity that can handle significantly more sites than is needed just for daily determination of EOP. While it is desirable that most of the extra antennas in each day's observing meet the VLBI2010 slew rate specification, the additional correlator capacity will also allow legacy antennas and special purpose antennas, such as those with large collecting area, to be included. Incorporating the added antennas into integrated observing schedules that overlap with the daily EOP schedules will enhance the connection to the stations that observe on a daily basis and hence have well established locations. The legacy and special purpose IVS antennas will have their own, unique roles in the VLBI2010 era, as they will:

- allow continuation of long legacy data records,
- extend the VLBI TRF for better global coverage,
- allow regional studies,
- extend the CRF to weaker sources,
- extend the CRF to higher frequency bands such as K, Ka, and Q (15, 32, and 43 GHz, respectively).

## 6.2 Transition Plan

The transition from current S/X observations to VLBI2010 observations is constrained by the IVS requirement for continuous operational products, so it is not permissible to shut down operations completely during the transition. Validating the new system against the old is also critical, in order to avoid systematic offsets between the products from the new and old systems.

The key to a successful transition plan is the inclusion of VLBI2010 operating modes that are backward compatible with legacy S/X systems. As they come on line, VLBI2010 sites can then

observe seamlessly with S/X sites. Mixed S/X-VLBI2010 observations have already been demonstrated, under limited conditions, as part of the NASA proof-of-concept project (Section 5).

Three stages of transition to VLBI2010 operations are anticipated ([Malkin, 2007](#)):

- The number of VLBI2010 stations is still small, say 2–5. At this stage, most VLBI2010-only sessions will be of an R&D nature for the purpose of investigating and optimizing station operations, optimal scheduling, data acquisition, data transfer, correlator operations, and automated data analysis. New antennas will also be incorporated into the existing S/X networks and observing programs to enhance the IVS network and to connect new antenna locations with the VLBI TRF.
- The number of VLBI2010 stations is intermediate, say 6–15. At this stage the VLBI2010 network will be running independent programs for EOP, TRF, and CRF, and legacy antennas will continue the current observing programs aimed at the same IVS products. Some sessions will use mixed networks of S/X and broadband stations, and the ties between the current and new networks will be strengthened. Comparisons of the EOP and CRF data products obtained with the old and new technologies will also become possible.
- The number of new stations is 16+ with good distribution over the globe. At this stage the new observing strategies discussed in Section 6.1 can be put into practice.

### 6.3 System Automation

One of the main impediments to the expansion of VLBI operations is the comparatively (vis-à-vis GNSS, for instance) large number of personnel needed at each site. High priorities in designing VLBI2010 have therefore been the development of systems that are robust and easy to repair, and the inclusion of automation into as many aspects as possible of VLBI processes, including schedule generation, station operations, and data analysis, the last of which is discussed in more detail in Section 6.4.

Current station operations are already automated to a large extent in that a software “field system” monitors and controls most of the station hardware from the antenna through the data recorder. However, personnel are still needed on site to download and start schedules, to load and unload record media, and to repair or reset malfunctioning subsystems, among other tasks. At most stations, personnel are expected to be on site continuously during operations.

In contrast, the vision of VLBI2010 station operations is that personnel will be required to be on site only to change and ship record media once per day at most, to perform maintenance periodically, and to make repairs as necessary, but otherwise will be only on call during operations, and possibly not on site. To turn this vision into reality, systems and processes must be engineered to have a much higher level of reliability than at present, and procedures need to be put in place to identify anomalous conditions and to alert on-call personnel when their presence is required on site. Identification of anomalous conditions requires that features be incorporated in the hardware for thorough testing of all subsystems and that software be put in place to automatically and thoroughly check the system on a regular basis.

An important innovation for VLBI2010 station operations is the development of a control center that is in constant communication with all stations actively involved in observations. For convenience it is possible for the control center to be transferred from location to location around the globe to follow daylight hours. To avoid problems when communication lines fail, each station will still be controlled by an on-site schedule file. However, the control center will be able to download and start new schedules, re-calculate schedules when network conditions change due to, for example, a failed station, monitor and control all subsystem functions, reset subsystems when

they malfunction, and contact on-call personnel when hands-on intervention is required. Centralized monitor and control of the entire network will have the added advantage of ensuring that configurations at all sites are compatible.

#### 6.4 Analysis Automation

An integral part of the VLBI2010 concept is (near)-real-time correlation processing for a subset of stations followed by rapid automated analysis for EOP determination. A seamless data flow is required from antenna back end to the uploading of EOP to the combination centers. To this end, reliable automated procedures will be needed at all stages of the VLBI data processing. Where these procedures do not exist, they need to be developed. Where they do exist, they need to be reviewed, updated as necessary, and integrated into a coherent VLBI2010 analysis process ([Malkin, 2008b](#)).

The set of operational data analysis tasks required for determination of EOP includes the following steps:

- Retrieve data files from the correlator and/or IVS data center.
- Compute and apply ionosphere correction.
- Resolve ambiguities.
- Interpolate meteorological parameters to the epochs of the observed scans.
- Retrieve or compute in situ other data used for analysis, such as a priori EOP, atmospheric loading, mapping function, tropospheric gradients, and master file.
- Perform estimation of parameters.
- Perform quality check.
- Upload results to IVS data center.

During EOP computation, the analyst usually needs to solve several tasks, as a rule in an interactive mode:

- choice of clock reference station,
- elimination of outliers,
- detection of clock breaks,
- cable calibration data handling,
- adjustment of parameterization,
- detection of abnormal station behavior and corresponding adjustment of the estimation procedure.

Many steps listed above are fully or partly automated at different IVS analysis centers and correlators, while others are under development. Partially automated computation of UT1 from Intensive sessions was implemented at the Institute of Applied Astronomy (IAA) IVS Analysis Center in 2001 ([Malkin et al., 2002](#); Malkin and Skurikhina, 2005). Advanced automated analysis procedures, which include earlier steps such as ambiguity resolution and thus cover the entire data path from correlation to UT1, were recently developed at the Kashima Space Research Center ([Koyama et al., 2008](#)).

However, the automated analysis of 24-hour sessions, with computation of the full set of EOP along with troposphere and other parameters of interest, is a more complicated task, and analysis of

these sessions often requires that decisions be made by the analyst. Experience shows that about 99% of Intensive sessions processed in the automated mode do not require re-visiting by an analyst, whereas only 80–85% of 24-hour sessions give satisfactory results if processed in a semi-automated mode. The rest of the sessions require manual intervention, mainly due to clock breaks and, to a lesser extent, due to other reasons such as choice of the clock reference station or excessive station noise.

To make automated data analysis simpler and more reliable, the formats of all operational files, such as station logs, meteorological data files, and correlator reports, need to be reviewed and standardized (Section 6.5).

## 6.5 New Data Structures

IVS Working Group 4 (WG4) on Data Structures was established at the 15 September 2007 IVS Directing Board meeting. The purpose of WG4 is to design a replacement for the current VLBI database.

Any new data structure must be able to store the data currently required to process VLBI sessions as well as to handle the needs of VLBI2010. The following summarizes some initial goals for a new format.

- *Compact.* The structure should minimize redundancy.
- *Accessible.* Users should be able to easily access the data without the need of custom software.
- *Different languages/different platforms.* The same structure should be accessible on different operating systems and by different languages.
- *Speed.* One should be able to add, modify, and retrieve data quickly.
- *Extensible.* It should be possible to add new data types, e.g., source structure maps, system temperatures, and system gain information.
- *Provenance.* Analysts should be able to retrieve the origin and history of the data.
- *Completeness.* The data structure should include all of the information necessary to process VLBI data from start to finish. Analysts should be able to redo the analysis from start to finish.
- *Different levels of abstraction.* There are many different kinds of users of VLBI data. The new structure should serve all of them. Many users may be interested only in the final delay. Experts may want access to data from an earlier processing stage.

## 6.6 Shipping and Media Requirements

A major operating expense for VLBI is the cost of shipping media between stations and correlators. VLBI2010 will be no different in this regard, as sensitivity trade-offs required to allow smaller, faster-slewing antennas lead to the need for significantly higher data volumes.

The current state of the art for data storage on affordable 3.5" high density disks (HDDs) is 1 TB. With the advent of new technologies, that capacity is expected to grow to 4 TB by 2011. A 32-TB 8-pack of 3.5" HDDs can therefore be considered a reasonable unit of disk storage at the anticipated start of significant VLBI2010 operations in 2012.

Based on the sensitivity considerations in Section 3.1, it is possible to calculate the number of 32-TB disk packs needed per day for a variety of operating conditions ([Petrachenko, 2008c](#)). As an

example, Figure 6-1 shows the relationship between the number of disk packs needed per day and  $N$ , the number of observed sources, where the sources are selected from the Petrov list (cf. Section 2.2) by decreasing flux density, i.e., only the strongest  $N$  sources in the list are used. As expected, as  $N$  increases, the average flux density decreases and hence more disk packs are needed per day. Plots are displayed for SNR targets of 10 and 14 and for typical source-switching intervals of 45 and 60 s.

For a typical operating scenario of six days observation and one day maintenance per week and a four-week buffer of recording media at each site, Figure 6-1 can be used to show that a media pool between 4 and 28 32-TB 8-packs is required per site. For the same operating scenario, between 100 and 720 one-way 8-pack shipments is required per site per year.

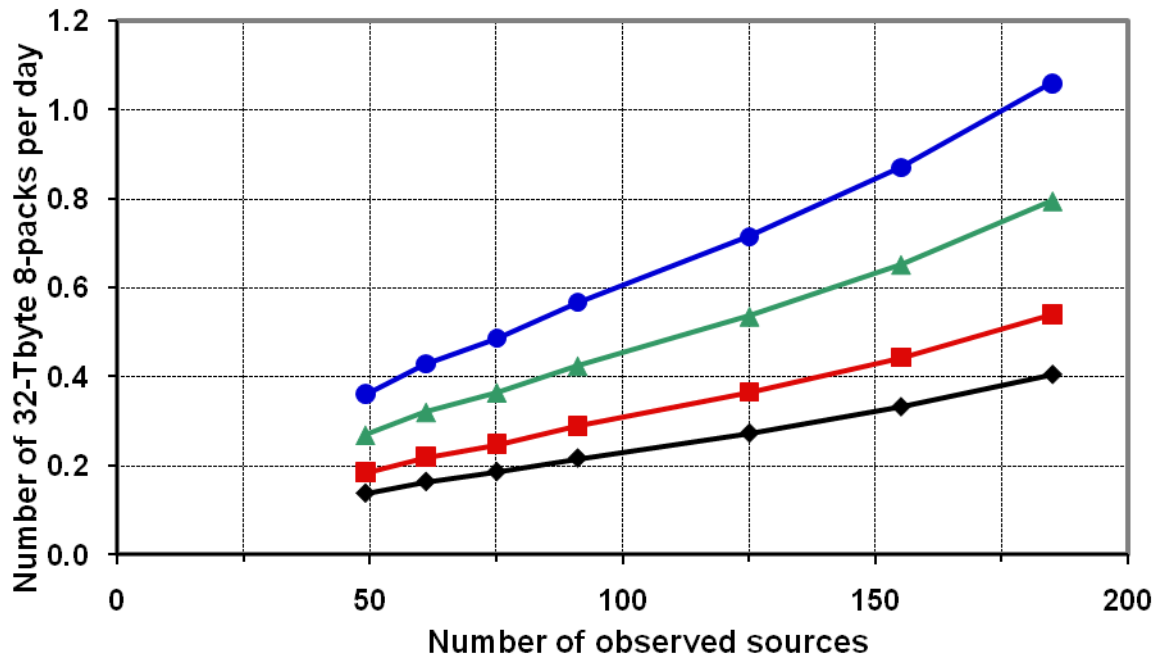

**Figure 6-1.** The number of 32-TB disk packs needed per day is plotted relative to  $N$ , the number of observed sources, where the sources are selected from the Petrov list by decreasing flux density. The SNR targets and source-switching intervals of the four scenarios are, from top curve to bottom: a) SNR=14 and  $\Delta T_{SRC}=45$  s, b) SNR=14 and  $\Delta T_{SRC}=60$  s, c) SNR=10 and  $\Delta T_{SRC}=45$  s, d) SNR=10 and  $\Delta T_{SRC}=60$  s.

These requirements can be expected to ease with time as disk capacity continues to increase. However, in the meantime, less demanding operating modes may be required.

## 6.7 e-VLBI

As can be inferred from Section 6.6, VLBI2010 operations starting in ~2012 could be supported at sustained data rates between 0.5 and 3.5 Gbps/station/day with traditional recording and shipping of disk modules. However, the cost of such a mode of operation is substantial, unmanned operation of sites is largely precluded, and processing turnaround times are a minimum of several days.

Although unproven for continuous VLBI operations at these sustained data rates, a more desirable mode of data transport is electronic transmission of data (e-VLBI), which would dramatically

reduce processing turnaround time and allow fully automated station operation. The 10-Gbps data interfaces being designed into the VLBI2010 system lend themselves naturally to network data transport and are well matched to the projected operational sustained data rates. Furthermore, most modern fiber networks are designed to support the multiplexing of many (up to 100 or more) individual optical wavelengths onto a single fiber with each wavelength typically supporting 10 Gbps.

For stations with suitable fiber connections to the correlator, data processing can take place in real-time or near-real-time, and a core subset of stations must be connected in this way to support time-critical EOP measurements. The data from this subset of stations may also need to be recorded at the correlator if subsequent correlation with shipped data from other stations is required. A fallback position for time-critical EOP operations where one or more stations are connected at less than real-time data rates would be post-observation e-VLBI transfer of data at lower speeds and recording on disks located at the correlator facility, as is currently done to support time-critical Intensive EOP processing.

The costs of installing and supporting e-VLBI data transfer will vary widely depending on several factors, including “last-mile” fiber installation costs (where necessary) as well as recurring usage or lease charges. Access to government-supported or research-and-engineering (R&E) networks will almost certainly be required within the foreseeable future to keep the latter costs to an acceptable level. It is difficult at this time to project such costs and how they may compare with traditional record-and-ship costs, but there is reason to be optimistic that these costs will be competitive and affordable for at least a subset of the stations.

## 7 Risks and Fallback Options

In this section, risks to accomplishing the goals of VLBI2010 are considered. These are divided into technical risks and organizational challenges.

### 7.1 Technical Risks

- *Antenna slew parameters.* Demanding slew rates are required to achieve 1-mm accuracy using a single antenna (Section 3.2). In addition to the high capital cost of fast antennas, large recurring costs related to power consumption, repair and maintenance, among other things, may be difficult to sustain. Since, as seen from Figure 3-3, the same level of performance can be achieved using a pair of slower-slewing antennas, costs and benefits of this option need to be weighed. The “two antenna” configuration has the added advantage of providing a completely redundant antenna system, making it possible to continue observations during maintenance and repair, thus providing a capability for truly continuous operation.
- *Sensitivity.* Adequate sensitivity is required to observe enough sources to establish a robust connection to the ICRF. Modern source lists include nearly 200 high-quality sources with flux densities above 250 mJy. At 250 mJy and under ideal conditions, a 12-m antenna with 50% efficiency, a system temperature of 50 K, and a data acquisition rate of 32 Gbps safely resolves broadband delay after about 10 s of integration. Real-world limitations related to RFI and source structure may seriously compromise the resolution process. Fallback options include the use of longer integrations, a higher minimum source flux density, or larger antennas. Each of these has a down side. Longer integrations increase the already high costs of shipping and media and also increase the source-switching interval with concomitant degradation in geodetic accuracy. Raising the flux density limit reduces the number of available sources and hence degrades the connection to the ICRF. Larger antennas increase capital and operating costs.



- *Data volume.* Achieving full VLBI2010 sensitivity with a 12-m antenna will require a sustained record/transfer data rate of at least 4 Gbps. Anticipated shipping and media costs for continuous observations with a network of 16 or more VLBI2010 antennas will therefore be much higher than those of today and may not be affordable at the outset. Fortunately, there is a long history of steadily increasing data storage density and transmission rate with time. As a result shipping, media, and transmission costs can be projected to decrease in the future. If necessary, in the short term, fallback observing scenarios may be required, e.g., increasing the minimum source flux density or increasing the average source-switching interval (Section 6.6).
- *Broadband delay.* Although the NASA proof-of-concept project is underway, the broadband delay technique has not been demonstrated at the time of this report. While no fundamental limitations have been identified, complications from RFI and source structure are a concern. As a fallback, options including an enhanced two-band system with a wider bandwidth in each band and wider spacing between bands have been considered ([Petrachenko, 2008a](#)). These systems can be expected to achieve on the order of 8–12 ps delay precision which, according to Figure 2-3, should not degrade performance significantly, although this large delay uncertainty may be insufficient for uncovering and understanding systematic errors.
- *RFI.* RFI is a major concern for VLBI2010 (Section 3.4), especially toward the lower end of the 2–14 GHz spectrum. The overall gain distribution of the system, sampler resolution, and digital processing algorithms are all being designed to be as robust as possible against RFI. In addition, with proper feed design, RFI from outside the band should be significantly attenuated. It is recognized that at some locations fixed input filters may be required and that flexibility of frequency selection for the broadband sequences is likely to be limited. It is expected that these precautions and limitations will result in a workable broadband system, but if all else fails, a final fallback option is an enhanced dual-band system, which may be more robust against strong RFI in regions of the spectrum that are not actively being used.
- *Operational costs.* In VLBI2010 an effort is being made to reduce operational costs through automation. This will be offset to some degree by added costs for shipping and data transmission, power, and maintenance for the fast-slewing antenna drive system and for the added operational antenna days that would be required to achieve continuous observations.
- *Network geometry.* An important aspect of VLBI2010 is the expansion of the IVS network toward a more uniform global distribution of stations. New VLBI2010 antennas are needed in all regions to improve connection to the ITRF and to improve the robustness of the ITRF scale. Therefore, a particular emphasis needs to be placed on the southern hemisphere where antennas are less plentiful. This is required to improve the CRF in the south celestial hemisphere and to reduce biases in source declination and station latitude due to global atmosphere gradients.

## 7.2 Organizational Challenges

Successful projects are usually characterized by well-defined requirements, agreed-upon specifications and schedules, and control of resources and personnel. The VLBI2010 project, as it stands today, has made significant progress toward establishing well-defined requirements and agreed-upon specifications. However, the voluntary nature of the IVS and the informal structure of the V2C make it difficult to move to the next phase of the project at which enforceable schedules are agreed upon and resources and personnel are committed. One model for moving forward, which has been used successfully for large international projects in other areas of science, is the establishment of a consortium of partners organized through a full-time project office. However, the comparatively small size of the VLBI2010 project, the globally dispersed distribution of potential partners, and their asynchronous and uncertain funding timelines make this approach

inappropriate and perhaps excessively formal. A more suitable approach may be to organize a small project executive group. Its main responsibilities would be to establish and to maintain best-effort schedules, to solicit expressions of interest and, eventually, commitments either to specific design, development, and production tasks or to contributions of project components such as antennas, correlators, and maintenance depots. It may be useful to formalize these intentions at a level similar to that currently used for components of the IVS.

## 8 Next Steps

- *Continue the NASA-sponsored broadband delay development and testing effort.* It has reached the point where two progenitor VLBI2010 front end receiver and back end systems have been built and are deployed at the Westford and GGAO antennas. Initial fringes have been detected between the systems, and evaluation of their sensitivity and stability is currently under study. The next major steps to be undertaken include:
  - Study the sensitivity and stability of the system over the full available spectrum, and at the same time gather information on the local RFI environments.
  - Develop processes for combining the linearly polarized correlation products to produce group delay estimates in each band.
  - Develop processes for forming the broadband delay and study its sensitivity requirements, stability, etc., using long continuous observations of single sources.
  - Study the impact on broadband delay of switching between sources in different areas of the sky.
  - Study the impact of source structure on broadband delay.
  - Test broadband delay with a geodetic schedule.
  - Install an Eleven feed when it becomes available and test it.
  - Begin to correlate data using an implementation of a small software correlator specifically tailored for geodetic applications and VLBI2010.
- *Continue development of the VLBI2010 subsystem recommendations.* The current state of VLBI2010 subsystem definitions is presented in this report. Some are quite advanced, e.g., antenna and site recommendations, while others, e.g., DBE and correlator, are only rudimentary. In March 2009 a workshop will be held in Wettzell to decide on VLBI2010 frequencies and feeds. This will be followed by a second workshop to discuss the definition of the VLBI2010 DBE and correlator. By the start of 2010 it is intended that all required subsystems be fully defined so that final development and prototyping can proceed for the VLBI2010 deployment.
- *Formalize the structure of the VLBI2010 project.*
  - Identify organizations to take responsibility for the design, prototyping, and production of final versions of all VLBI2010 subsystems from the feed and front end receiver to the data recorder.
  - Identify organizations to take responsibility for the design and implementation of VLBI2010 correlators.
  - Develop timelines, including identification of persons and organizations responsible for completion of tasks.

- *Promote the expansion of the VLBI2010 network.* Due to long lead times, it is important to start the process of acquiring antennas as soon as possible. In a few cases (e.g., Wettzell Twin Telescope and AuScope network), proposals have already been accepted, and detailed design or construction is underway. Groups should be solicited to fund, install, and operate antennas in regions of the globe where antennas are lacking, especially in the southern hemisphere.
- *Develop a research network to study the effectiveness of broadband delay, short source-switching intervals, atmosphere measurements and models, instrumental calibrations, antenna deformation measurements, and site ties.* The optimal network would be only a few hundred kilometers in extent, so that atmosphere conditions at the sites are independent but the effects of EOP and source structure errors are minimal. Such a network will be invaluable for refining the most effective methods for reducing random and systematic errors. Since GNSS results on the same short baseline will be comparatively free of orbit determination errors, they will provide an excellent independent comparison of performance, including site ties. Even a single baseline with VLBI2010 electronics and fast slewing antennas would be of great value. An example might be a continuation of the broadband delay proof-of-concept baseline but with dedicated fast-slewing antennas.
- *Develop a small reference antenna for monitoring antenna deformations and site ties (Section 3.6).* The development of such an antenna is not dependent on VLBI2010 electronics and could begin immediately. This approach shows great promise for a unified automatic approach to site ties, which is an integral aspect of GGOS.
- *Continue with research into scheduling strategies.* In addition to the two scheduling strategies used in the VLBI2010 simulations, further work to optimize scheduling with respect to the new operating modes and antennas is planned. A research project dealing with these issues has been started at IGG Vienna (Schuh, 2008).
- *Continue with studies of source-structure corrections.* Theoretical studies of source-structure corrections are nearly complete (Section 3.7). If the results are promising, S/X observations with the RD-VLBA network should be made to test the concepts.
- *Study VLBI2010 analysis requirements.* VLBI2010 will introduce many novelties, including a completely new observable, the broadband delay; four flexible bands instead of the usual S/X; a need for greater analysis automation; many more observations per session; and many more clock and atmosphere estimation intervals per session. Building on the analysis development for the V2C simulations and the WG4 work on data structures, the analysis enhancements required for VLBI2010 need to be identified and a plan created for their implementation.

## Acknowledgements

Many people contributed in a number of different ways to the VLBI2010 project and their efforts are greatly appreciated. In particular the authors would like to thank the following persons: Tom Clark, Chopo Ma, Alan Rogers, Hayo Hase, Sandy Weinreb, Hamdi Mani, and Marshall Eubanks. The proof-of-concept demonstration has been funded by NASA's Earth Surface and Interior Focus Area through the efforts of John Labrecque, Chopo Ma, and Herb Frey. The demonstration was the result of the efforts of Bruce Whittier, Mike Titus, Jason SooHoo, Dan Smythe, Alan Rogers, Jay Redmond, Mike Poirier, Arthur Niell, Chuck Kodak, Alan Hinton, Ed Himwich, Skip Gordon, Mark Evangelista, Irv Diegel, Brian Corey, Tom Clark, and Chris Beaudoin. We thank Wolfgang Schlüter for his support at the inception of the VLBI2010 project and Harald Schuh for his continuing support in their roles as Chair of the IVS Directing Board.

The authors would like to acknowledge the generous VLBI2010-related support of their affiliated agencies.

VLBI2010 research at MIT Haystack is conducted under NASA contract NNG05HY04C.

Andrea Pany is recipient of a DOC-fFORTE fellowship of the Austrian Academy of Sciences at the Institute of Geodesy and Geophysics, Vienna University of Technology.

Jörg Wresnik is funded by the FWF Austrian Science Fund, project title: Optimum design of geodetic VLBI network and observing strategies, P18404-N10.

## References

- d'Auria, G., F. S. Marzano, and U. Merlo, Model for estimating the refractive-index structure constant in clear-air intermittent turbulence, *Applied Optics*, vol. 32, pp. 2674–2680, 1993.
- Bar-Sever, Y. E., C.S. Jacobs, S. Keihm, G.E. Lanyi, C.J. Naudet, H.W. Rosenberger, T.F. Runge, A.B. Tanner, and Y. Vigue-Rodi, Atmospheric Media Calibration for the Deep Space Network, *Proc. IEEE*, vol. 95, pp. 2180–2192, 2007.
- Böhm, J., R. Heinkelmann, H. Schuh, and A. Nothnagel, Validation of Mean Temperature Values as Provided by GPT, *IVS Memorandum 2008-003v02*, 2008.
- Böhm, J., B. Werl, and H. Schuh, Troposphere mapping functions for GPS and very long baseline interferometry from European Centre for Medium-Range Weather Forecasts operational analysis data, *J. Geophys. Res.*, 111, B02406, doi:10.1029/2005JB003629, 2006.
- Böhm, J., J. Wresnik, and A. Pany, Simulation of wet zenith delays and clocks, *IVS Memorandum 2006-013v03*, 2007.
- Bolli, P., S. Montaguti, M. Negusini, P. Sarti, L. Vittuari, G.L. Deiana, Photogrammetry, Laser Scanning, Holography and Terrestrial Surveying of the Noto VLBI Dish, in *IVS 2006 General Meeting Proceedings*, ed. by D. Behrend and K. Baver, NASA/CP-2006-214140, pp. 172–176, 2006.
- Brisken, W., Software Correlation for VLBI2010, private communication, Feb. 4, 2008.
- Collioud, A. and P. Charlot, Imaging Capabilities of the Next Generation VLBI System, in *Measuring the Future – Proceedings of the Fifth IVS General Meeting*, ed. by A. Finkelstein and D. Behrend, Saint Petersburg, Nauka, ISBN 978-5-02-025332-2, pp. 433–438, 2008.
- Corey, B., Notes on Antenna Polarization and VLBI Observables, *IVS Memorandum 2007-011v01*, 2007.
- DeBoer, D., W.J. Welch, J. Dreher, J. Tarter, L. Blitz, M. Davis, M. Fleming, D. Bock, G. Bower, J. Lugtem, Girmay-Keleter, L. D'Addario, G. Harp, R. Ackermann, S. Weinreb, G. Engargiola, D. Thornton, and N. Wadefalk, The Allen Telescope Array, *Proc. SPIE Vol. 5489, Ground-based Telescopes*, J.M Oschmann (ed.), pp 1021–1028, 2004.
- Deller, A.T., S.J. Tingay, M. Bailes, C. West, DiFX: A Software Correlator for Very Long Baseline Interferometry Using Multiprocessor Computing Environments, *The Publications of the Astronomical Society of the Pacific*, Volume 119, Issue 853, pp.318–336, 2007.
- Drewes, H., The International Space Geodetic and Gravimetric Network (ISGN). In: G. Beutler, H. Drewes, H. Hornik (Eds.): *Commission VIII - International Coordination of Space Techniques for Geodesy and Geodynamics (CSTG)*, Progress Report 1998. IAG CSTG Bulletin No. 15, 13–15, DGFI, Munich 1999.
- Elgered, G., J. L. Davis, T. A. Herring, and I. I. Shapiro, Geodesy by Radio Interferometry: Water Vapor Radiometry for Estimation of the Wet Delay, *Radio Sc.*, vol. 96, pp. 6541-6555, 1991.
- Emardson, T. R., G. Elgered, and J. M. Johansson, External Atmospheric Correction in Geodetic Very-Long-Baseline Interferometry, *J. Geodesy*, vol. 73, pp. 375-383, 1999.
- Eresmaa, R., S. Healy, H. Jaervinen, and K. Salonen, Implementation of a ray-tracing operator for ground-based GPS Slant Delay observation modeling, *J. Geophys. Res.*, 113, D11114, doi:10.1029/2007JD009256, 2008.

- Fey, A. and P. Charlot, VLBA Observations of Radio Reference Frame Sources. II. Astrometric Suitability Based on Observed Structure, *The Astrophysical Journal Supplement Series*, vol. 111, pp. 95–142, 1997.
- Fey, A. and P. Charlot, VLBA Observations of Radio Reference Frame Sources. III. Astrometric Suitability of an Additional 225 Sources, *The Astrophysical Journal Supplement Series*, vol. 128, pp. 17–83, 2000.
- Fomalont, E., VLBA Phase Referencing for Astrometric Use, in *IVS 2006 General Meeting Proceedings*, ed. by D. Behrend and K. Baver, NASA/CP-2006-214140, pp. 307–315, 2006.
- GGOS, *The Global Geodetic Observing System: Meeting the requirements of a global society on a changing planet in 2020 (GGOS 2020 book)*, ed. by H.-P. Plag and M. Pearlman, submitted to Springer Verlag, ~370 pp., 2009.
- Heinkelmann, R., J. Böhm, and H. Schuh, Effects of Surface Pressure and Temperature on the VLBI Reference Frames, in *Measuring the Future – Proceedings of the Fifth IVS General Meeting*, ed. by A. Finkelstein and D. Behrend, Saint Petersburg, Nauka, ISBN 978-5-02-025332-2, pp. 188–192, 2008.
- Herring, T.A., J.L. Davis, and I.I. Shapiro, Geodesy by Radio Interferometry: The Application of Kalman Filtering to the Analysis of Very Long Baseline Interferometry Data, *Journal of Geophysical Research*, Vol. 95, No. B8, 1990.
- Himwich, E., and B. Corey, VLBI2010 Antenna Control Recommendations, *IVS Memorandum 2009-003v01*, March 12, 2009.
- Hobiger T., R. Ichikawa, Y. Koyama, and T. Kondo, Fast and accurate ray-tracing algorithms for real-time space geodetic applications using numerical weather models, *Journal of Geophysical Research*, under review, 2008a.
- Hobiger T., R. Ichikawa, T. Takasu, Y. Koyama, and T. Kondo, Ray-traced troposphere slant delays for precise point positioning, *Earth, Planets and Space*, Vol. 60, No. 5, e1–e4, 2008b.
- Hobiger T., M. Sekido, Y. Koyama, and T. Kondo, Integer phase ambiguity estimation in next-generation geodetic Very Long Baseline Interferometry, *J. Adv. Space Res.*, doi:10.1016/j.asr.2008.06.004, 2008c.
- Ichikawa, R., A. Ishii, H. Takiguchi, H. Kuboki, M. Kimura, J. Nakajima, Y. Koyama, T. Kondo, M. Machida, S. Kurihara, K. Kokada, and S. Matsuzakas, Development of a Compact VLBI System for Providing over 10-km Baseline Calibration, in *Measuring the Future – Proceedings of the Fifth IVS General Meeting*, ed. by A. Finkelstein and D. Behrend, Saint Petersburg, Nauka, ISBN 978-5-02-025332-2, pp. 400–404, 2008.
- IGS, IGS Site Guidelines, IGS Central Bureau, Jet Propulsion Laboratory/Caltech, <http://igscb.jpl.nasa.gov/network/guidelines/guidelines.html>, 2007.
- Imbriale, W., S. Weinreb, and H. Mani, Design of a Wideband Radio Telescope, *IEEE Aerospace Conference, Big Sky, Montana*, March 3–10, 2007, pp. 1–12, 2007.
- Jacobs, C.S., S.J. Keihm, G.E. Lanyi, C.J. Naudet, L. Riley, A.B. Tanner, Improving Astrometric VLBI by using Water Vapor Radiometry Calibrations, in *IVS 2006 General Meeting Proceedings*, ed. by D. Behrend and K. Baver, NASA/CP-2006-214140, pp. 336–340, 2006a.
- Jacobs, C.S., G.E. Lanyi, C.J. Naudet, O.J. Sovers, L.D. Zhang, P. Charlot, E.B. Fomalont, D. Gordon, C. Ma, KQ VLBI Collaboration, Extending the ICRF to Higher Radio Frequencies: Global Astrometric Results at 24 GHz, in *IVS 2006 General Meeting Proceedings*, ed. by D. Behrend and K. Baver, NASA/CP-2006-214140, p. 320, 2006b.

- Jacobs, C.S., and O.J. Sovers, Extending the ICRF above S/X-band: X/Ka-band Global Astrometric Results, in *Measuring the Future – Proceedings of the Fifth IVS General Meeting*, ed. by A. Finkelstein and D. Behrend, Saint Petersburg, Nauka, ISBN 978-5-02-025332-2, pp. 284–288, 2008.
- Koyama, Y., private communication, 2004.
- Koyama, Y., M. Sekido, T. Hobiger, H. Takiguchi, and T. Kondo, Developments of an Automated Data Processing System for Ultra Rapid dUT1 e-VLBI Sessions, in *Measuring the Future – Proceedings of the Fifth IVS General Meeting*, ed. by A. Finkelstein and D. Behrend, Saint Petersburg, Nauka, ISBN 978-5-02-025332-2, pp. 405–409, 2008.
- MacMillan, D., Simulations Studies at Goddard, IVS Memorandum 2006-015v02, Apr. 25, 2006.
- MacMillan, D., Comparisons of Observed and Simulated CONT05 Repeatabilities for Different Turbulence Cn Models, IVS Memorandum 2008-010v01, Jul. 22, 2008.
- MacMillan, D. and R. Sharma, Sensitivity of VLBI2010 Simulations to Parameterization of Input Simulated Turbulence, Clock and White Noise, IVS Memorandum 2008-011v01, Jul. 25, 2008.
- Malkin, Z., On the IVS2010 Transition Plan and Using of Old Antennas), IVS Memorandum 2007-012v01, Nov. 5, 2007.
- Malkin, Z., VLBI2010 Core Station Standard, IVS Memorandum 2008-016v01, Sep. 6, 2008a.
- Malkin, Z., VLBI2010 Towards Automated Data Analysis, IVS Memorandum 2008-017v01, Sep. 7, 2008b.
- Malkin Z. and E. Skurikhina. OCCAM/GROSS Software Used at the IAA EOP Service for processing of VLBI Observations. *Transactions. IAA*, vol. 12, pp. 54–67, 2005. (in Russian)
- Malkin Z., E. Skurikhina, M. Sokolskaya, G. Krasinsky, M. Vasilyev, V. Gubanov, I. Surkis, I. Kozlova, and Yu. Rusinov, IAA VLBI Analysis Center Report 2001. In: N.R.Vandenberg, K.D.Baver (Eds.), *IVS 2001 Annual Report*, NASA/TP-2002-210001, pp. 220–223, 2002.
- Niell, A.E., Interaction of Atmosphere Modeling and VLBI Analysis Strategy, in *IVS 2006 General Meeting Proceedings*, ed. by D. Behrend and K. Baver, NASA/CP-2006-214140, pp. 252–256, 2006a.
- Niell, A.E., Source Structure Simulation, IVS Memorandum 2006-017v01, August 9, 2006b.
- Niell, A.E., Source Structure Examples, IVS Memorandum 2006-018v01, August 29, 2006c.
- Niell, A.E., Simulation networks - 1, IVS Memorandum 2007-001v01, February 1, 2007.
- Niell, A.E., A. Whitney, B. Petrachenko, W. Schlüter, N. Vandenberg, H. Hase, Y. Koyama, C. Ma, H. Schuh, and G. Tuccari, VLBI2010: Current and Future Requirements for Geodetic VLBI Systems, 2005 IVS Annual Report, pp. 13–40, 2006.
- Nilsson, T., R. Haas, and G. Elgered, Simulation of atmospheric path delays using turbulence models, *Proceedings of the 18th European VLBI for Geodesy and Astrometry Working Meeting*, 12-13 April 2007, edited by J. Böhm, A. Pany, and H. Schuh, *Geowissenschaftliche Mitteilungen*, Heft Nr. 79, Schriftenreihe der Studienrichtung Vermessung und Geoinformation, Technische Universität Wien, 2007.
- Nilsson, T. and R. Haas, Modeling Tropospheric Delays with Atmospheric Turbulence Models, in *Measuring the Future – Proceedings of the Fifth IVS General Meeting*, ed. by A. Finkelstein and D. Behrend, Saint Petersburg, Nauka, ISBN 978-5-02-025332-2, pp. 361–370, 2008.

- Pany, A., J. Wresnik, and J. Böhm, Vienna VLBI2010 PPP Simulator, IVS Memorandum 2008-012v01, Aug. 14, 2008a.
- Pany, A., J. Wresnik, and J. Böhm, Investigation of the Impact of Random Error Sources on Position Repeatability using the VLBI2010 PPP Simulator, IVS Memorandum 2008-013v01, Aug. 14, 2008b.
- Pany, A., J. Wresnik, and J. Böhm, VLBI2010 analysis strategies tested with the PPP Simulator, IVS Memorandum 2008-018v01, 2008c.
- Petrachenko, B., A Monte Carlo Simulator for Geodetic VLBI, IVS Memorandum 2006-011v01, December 16, 2005.
- Petrachenko, B., Performance Comparison between Traditional S/X and X/Ka Systems and a Broadband S-Ku System, IVS Memorandum 2006-016v01, July 12, 2006.
- Petrachenko, B., A Proposed VLBI2010 Observing Scenario, IVS Memorandum 2007-007v01, August 21, 2007.
- Petrachenko, B., Performance of Broadband Delay (BBD) Sequences, IVS Memorandum 2008-005v01, June 20, 2008a.
- Petrachenko, B., VLBI2010 Antenna Slew Rate Considerations, IVS Memorandum 2008-008v01, July 7, 2008b.
- Petrachenko, B., VLBI2010 Sensitivity and Data Storage Requirements, IVS Memorandum 2008-009v01, July 15, 2008c.
- Petrachenko, B., VLBI2010 Digital Back End (DBE) Requirements, IVS Memorandum 2008-014v01, Aug. 26, 2008d.
- Petrachenko, B., VLBI2010 Frequency Considerations, IVS Memorandum 2008-015v01, Aug. 27, 2008e.
- Petrachenko, B., and M. Bérubé, VLBI2010 Source Map Alignment Simulation, IVS Memorandum, 2007-008v01, August 22, 2007.
- Petrachenko, B., J. Böhm, D. MacMillan, A. Pany, A. Searle, and J. Wresnik, VLBI2010 Antenna Slew Rate Study, in *Measuring the Future – Proceedings of the Fifth IVS General Meeting*, ed. by A. Finkelstein and D. Behrend, Saint Petersburg, Nauka, ISBN 978-5-02-025332-2, pp. 410–415, 2008.
- Petrov, L., Using source maps for scheduling and data analysis: approaches and strategies, *Proceedings of the 18th European VLBI for Geodesy and Astrometry Working Meeting*, 12-13 April 2007, edited by J. Böhm, A. Pany, and H. Schuh, *Geowissenschaftliche Mitteilungen*, Heft Nr. 79, Schriftenreihe der Studienrichtung Vermessung und Geoinformation, Technische Universität Wien, 2007.
- Rogers, A.E.E., Simulations of broadband delay measurements, Mark 5 memo #043, 2006.
- Rogers, A.E.E., Preliminary test of new “digital” phase calibrator, BBDev memo #023, 2008.
- Schuh, H., SCHED2010: Next Generation Scheduling for VLBI2010, Project P21049, FWF Austrian Science Fund, <http://www.fwf.ac.at/en/abstracts/abstract.asp?L=E&PROJ=P21049>, 2008.
- Shaffer, D.B., RFI: Effects on Bandwidth Synthesis, IVS 2000 General Meeting Proceedings, p. 402–406, Feb. 21–24, 2000.



- Tatarskii, V. I., The Effects of the Turbulent Atmosphere on Wave Propagation. Jerusalem: Israel Program for Scientific Translations, 1971.
- Treuhaf, R. N. and G. E. Lanyi, The effect of the dynamic wet troposphere on radio interferometric measurements, Radio Sci., vol. 22, no. 2, pp. 251–265, 1987.
- US SKA Consortium, 2004 Update on the Large-N/Small-D SKA Concept: Technology Development and Demonstrators, SKA Demonstrator Plans – June 2004, [http://www.skatelescope.org/PDF/US\\_dem.pdf](http://www.skatelescope.org/PDF/US_dem.pdf)
- Wresnik, J. and J. Böhm, V2C Simulations at IGG Vienna, IVS Memorandum 2006-010v03, Sep. 7, 2006.
- Wresnik, J., A. Pany, and J. Böhm, Evaluation of New Cn Values for the Turbulence Model with CONT05 Real Data, IVS Memorandum 2008-004v01, Jun.19, 2008a.
- Wresnik, J., A. Pany, and J. Böhm, Impact of Turbulence Parameters on VLBI2010 Simulation Results with OCCAM Kalman Filter, IVS Memorandum 2008-007v02, Jul. 15, 2008b.

## Appendices

### Appendix A. Structure Constants and Wet Effective Heights.

Atmospheric turbulence causes spatial and temporal variations in the refractive index of the air. These cause fluctuations in the atmospheric delay of radio signals. According to the theory of Kolmogorov turbulence the variations in the refractive index  $n$  can be described by the structure function (e.g., Tatarskii, 1971):

$$\langle (n(\vec{r}_1, t_1) - n(\vec{r}_2, t_2))^2 \rangle = C_n^2 \|\vec{r}_1 + \vec{v}t_1 - \vec{r}_2 - \vec{v}t_2\|^{2/3} \quad (\text{A-1})$$

where  $\vec{r}_i$  is the position,  $t_i$  the time,  $\vec{v}_i$  the wind velocity vector, and  $C_n$  is the refractive index structure constant. Here it is assumed that temporal variations in the refractive index are caused by the air moving with the wind (Taylor's frozen flow hypothesis).

Using Equation (A-1), it is possible to calculate the covariance matrix  $C$  for the variations in equivalent zenith wet delays (slant wet delays divided by the wet mapping function):

$$[C]_{i,j} = \langle (l_i - l_0)(l_j - l_0) \rangle \quad (\text{A-2})$$

where  $l_i$  is the equivalent zenith wet delay of direction  $i$  at time  $t_i$ , and  $l_0$  the initial zenith wet delay. For more details about the calculations, see [Nilsson et al. \(2007\)](#) and [Nilsson and Haas \(2008\)](#). Using a Cholesky decomposition of  $C$  (i.e., finding  $D$  so that  $C=DD^T$ ), simulated equivalent zenith wet delays can be generated by:

$$\vec{l} = l_0 + D\vec{n} \quad (\text{A-3})$$

where  $\vec{n}$  is a vector of zero mean Gaussian distributed random numbers with variance 1.

In order to calculate the covariance matrix  $C$  we need to know the structure constant  $C_n$  and the wind velocity vector. Furthermore we need to know the initial zenith wet delay  $l_0$  in order to simulate the atmospheric delays. The wind velocity for a site can be obtained from, for instance, numerical weather models.  $l_0$  can be taken to be the mean zenith wet delay of the site. A simplifying assumption that  $C_n$  is constant up to an effective height  $H$  and zero above is often used (e.g., [Treuhaft and Lanyi, 1987](#)). The effective height  $H$  can be set to be the scale height of atmospheric water vapor, i.e., it can be estimated from numerical weather models. The value of  $C_n$  is however more difficult to estimate accurately.

One possible way to estimate the profile of  $C_n$  is to use high resolution radiosonde data. Methods exist which relate  $C_n^2$  to the mean vertical potential refractive index gradient  $M$ :

$$C_n^2 = a^2 FL_0^{4/3} M^2 \quad (\text{A-4})$$

where  $a^2=2.8$ ,  $L_0$  is called the outer scale of turbulence (typically in the range 5–100 m), and  $F$  the fraction of the air which is turbulent ([d'Auria, 1993](#)). One problem with this method is that it can only be used under cloud free conditions. Another problem is that some quantities (i.e.,  $L_0$  and  $F$ ) are generally not known accurately, hence their statistical distributions have to be assumed. This means that the method is only useful for determining long-time averages of the  $C_n$  profile, and that there may be errors if the wrong statistical properties are assumed.

The  $C_n$  values used in the simulations were determined using radiosonde data from two locations, Barrow, Alaska and Southern Great Plains, Oklahoma, observed in March 2004. In the determination of  $C_n$  the values  $L_0=50$  m and  $F=0.1$  were assumed, which are typical for these parameters ([d'Auria, 1993](#)). Since the approximation of constant  $C_n$  up to an effective height  $H$  was used in the simulations, the constant  $C_n$  value for each of the radiosonde sites was estimated as the mean  $C_n$  of the lowest 1 km of the atmosphere. These values were then interpolated/extrapolated from the locations of the radiosonde launch sites to the locations of the VLBI sites, assuming that

$C_n$  only depends on latitude. The effective heights  $H$  were estimated from ECMWF data. The obtained values are listed below.

```

%-----
% Parameters for atmospheric modeling (turbulence) for 40 VLBI2010 stations
%-----
% - Cn based on model-fit to high-resolution radiosonde observations
% - mean Trop-h based on fit to ERA40 data for March 2002
% - mean Wind at 850 hPa from ERA40 data for March 2002
%-----
% R.Haas and T. Nilsson, 2007-11-06
% Chalmers University of Technology, Onsala Space Observatory
%-----
%ID      Station name      average Cn      mean Trop-h      mean wind at 850hPa
%          [m^(-1/3)]      [m]              speed [m/s] az [deg]
%-----
BA      BADARY              0.860027e-7      1815.4943         4.7496  86.9933
BN      BAN2                  2.466039e-7      1678.9426         4.0975 -32.4796
HH      HARTRAO                2.028542e-7      1851.3535         3.4897 -54.3323
HO      HOBART26              1.157924e-7      2043.1756         11.5446 74.7812
KK      KOKEE                  2.297883e-7      1779.4592         5.5165 -37.5167
NY      NYALES20               0.349468e-7      1844.9730         7.4829   4.0280
TS      TSUKUB32              1.445493e-7      1911.5739         10.5455 84.3789
WZ      WETTZELL               0.938080e-7      1856.2057         7.9631 32.0023
FT      FORTLEZA              2.466039e-7      2141.9338         7.6980 -67.6056
GC      GILCREEK              0.554994e-7      1963.2784         7.5199 -59.6379
KE      KERG                   0.931880e-7      2088.5080         17.8279 79.0009
KW      KWJ1                   2.466039e-7      1628.8475         9.5635 -99.8577
MS      MAS1                   1.906584e-7      1890.5852         7.6967   6.8017
TA      TAHITI                 2.466039e-7      2077.6285         5.5753 -12.1229
TC      TIGOCONC              1.411861e-7      2175.6619         5.1014 76.2553
WF      WESTFORD              1.165242e-7      2268.7114         13.0499 65.5989
AU      AUCK                   1.433560e-7      1864.0093         8.3064  1.5179
GD      Goldston               1.479926e-7      2130.5076         4.8198  8.3134
HY      HALY                   1.824938e-7      1901.3589         6.2506 17.8366
MA      MALI                   2.466039e-7      1877.0075         4.9969 -76.8905
KA      KATHERIN               2.466039e-7      1978.8791         9.6918 -69.3541
QA      QAQ1                   0.645369e-7      1775.6118         10.0091 32.3462
RI      RIOP                   2.466039e-7      2414.2041         1.2533 -96.6994
YR      YARRAGAD              1.782477e-7      1939.7270         5.7577   6.6963
DG      DGAR                   2.466039e-7      2291.1460         5.9695 69.1032
IS      ISPA                   1.950707e-7      1977.7792         4.4918 -43.8065
LP      LPGS                   1.522734e-7      2030.8505         7.4932 28.5843
MK      MSKU                   2.466039e-7      2271.7389         2.4047 -11.2676
ND      NewDelhi               1.854215e-7      1751.8718         4.7775 95.1590
PA      PALAU                  2.466039e-7      2217.2973         7.6139 -75.7237
SA      SASK                   0.850104e-7      1843.3937         7.9263 83.1042
ZC      ZELENCHK              1.120531e-7      1969.6235         6.2397 41.6703
BR      BRMU                   1.640137e-7      2009.9043         8.4550 11.9532
IN      INEG                   2.345611e-7      2241.5587         1.4226 39.2018
IQ      IQQE                   2.452991e-7      2111.6343         1.7635 101.0215
KU      KUNM                   2.085144e-7      1771.3422         1.7346 40.9947
MC      MCM4                   0.366438e-7      2270.4486         5.6440 37.5639
OH      OHIGGINS               0.586397e-7      1869.2954         7.2638 15.7221
SV      SVETLOE                0.643233e-7      1705.4800         11.2561 68.5330
SY      SYOWA                  0.485575e-7      2116.4287         9.0917 -88.3625
%-----

```

## Appendix B. Glossary.

ASD	Allan Standard Deviation
ATA	Allen Telescope Array
az-el	azimuth/elevation (mount)
BBC	Baseband Converter
clk	Clock value
CONT05	Continuous VLBI Campaign 2005
CRF	Celestial Reference Frame
CCW	counter-clockwise
CP	Circular Polarization
CW	clockwise
DBE	Digital Back End
DORIS	Doppler Orbitography and Radio-positioning Integrated by Satellite
DQA	Data Quality Analyzer
DSN	NASA Deep Space Network
EOP	Earth Orientation Parameters
FFT	Fast Fourier Transform
FPGA	Field Programmable Gate Array
GGAO	Goddard Geophysical and Astronomical Observatory
GGOS	Global Geodetic Observing System
GNSS	Global Navigation Satellite System
GSFC	Goddard Space Flight Center
HDD	High Density Disk
HPBW	Half-Power Beamwidth
IAG	International Association of Geodesy
IAU	International Astronomical Union
iBOB	interconnect Break-Out Board
IF	intermediate frequency
IGS	International GNSS Service
ICRF	International Celestial Reference Frame
ITRF	International Terrestrial Reference Frame
IVS	International VLBI Service for Geodesy and Astrometry
JPL	Jet Propulsion Laboratory
LNA	Low-Noise Amplifier
LO	Local Oscillator
LP	Linear Polarization
MIT	Massachusetts Institute of Technology
mfw	Mapping Function Wet
MTBF	Mean Time Between Failures
NASA	National Aeronautics and Space Administration
NRCan	Natural Resources Canada
NZ	Nyquist Zone
OTT	over-the-top (antenna mount)
PPF	Polyphase Filter
PPP	Precise Point Positioning
R&D	Research and Development
RAM	Random Access Memory
RF	Radio Frequency
RFI	Radio Frequency Interference

SKA	Square Kilometre Array
SLR	Satellite Laser Ranging
SNR	Signal-to-Noise Ratio
STD	standard (antenna mount)
TCP	Transmission Control Protocol
TRF	Terrestrial Reference Frame
UDC	Up-Down Converter
V2C	VLBI2010 Committee
VLBI	Very Long Baseline Interferometry
VSI	VLBI Standard Interface
WG3	Working Group 3
WG4	Working Group 4
wn	White Noise
WVR	Water Vapor Radiometer
zwd	Zenith Wet Delay

# New Zealand 12-m VLBI Station for Geodesy and Astronomy

*Sergei Gulyaev, Tim Natusch*

## Abstract

This report summarizes the radio astronomical and VLBI activities recently started in New Zealand. It provides geographical and technical details of a new 12-m geodetic VLBI antenna being operated by Auckland University of Technology. Details of the VLBI system to be installed in the station are outlined. A co-located GNSS station and specialized surveying equipment are also described.

## 1. Introduction

The IVS report [1] proposes a number of strategies to improve the long-term accuracy of geodetic VLBI with an eye to achieving 1 mm long-term accuracy on baselines. Among these strategies are: “to increase the number of antennas and improve their geographic distribution” and “to increase the number of observations per unit of time”. These IVS strategies can best be addressed through construction of new small (10-12 m), fast moving antennas in areas that are under-represented (Australia) or lack geodetic VLBI stations (New Zealand).



Figure 1. New Zealand 12-m VLBI antenna and the installation crew (Godwin, Gulyaev, Cato, Woodburn, Natusch, and Steinbach). September 2008. (Photo: Greg Bowker)

Developing this approach, Auckland University of Technology (AUT) has invested US \$1m in a

geodetic VLBI system, consisting of a new 12-m antenna, a hydrogen maser clock, digital receiving and backend equipment, and 10 Gbps network connectivity.

As a preliminary step towards establishing a full geodetic capability for New Zealand, the first Trans-Tasman (Australia — New Zealand) VLBI test was conducted as early as 2005 between an AUT system installed on a 6-m dish located near Auckland and six 22-m antennas of the Australia Telescope Compact Array (ATCA) in Narrabri, New South Wales. This work was successful, with fringes located from the recorded data and a high-resolution image of quasar PKS1921-231 obtained for the first time [2, 3]. In 2006 the New Zealand 6-m antenna took part in a three-way VLBI experiment with participation of the ATCA and the 34-m antenna in Kashima, Japan. Though New Zealand has demonstrated the capacity to contribute to modern radio astronomical and VLBI research, the principal problem for further development was the lack of an appropriate modern radio telescope suitable for geodetic VLBI.

The new 12-m antenna installed in August—September 2008, and officially launched on 8 October 2008 (Figure 1), is intended to comprehensively address this problem.

## 2. Geographical Information

The New Zealand VLBI Station is located at Satellite Station Valley some 5 km south of the township of Warkworth, which is about 60 km north of the city of Auckland (Figure 2).

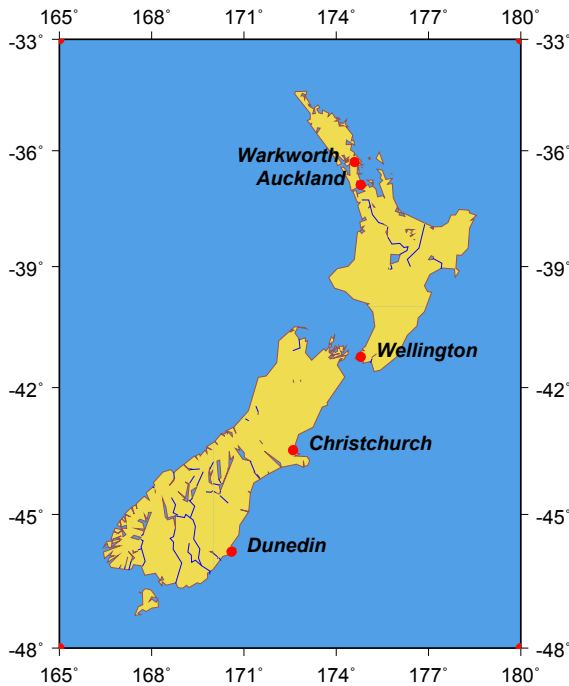

Figure 2. Map of New Zealand. Position of Warkworth is indicated. (Projection: Mercator)

The valley is owned by Telecom New Zealand with several satellite dishes installed (34-m is the biggest one) and operated to provide communication between New Zealand and Pacific Islands (Fiji, Cook Islands, Samoa). The dishes are directed towards geostationary satellites to the north

of the site and operate in C-band (4 and 6 GHz). The location is reasonably radio quiet (see Figure 3 for RFI measurements at the site) and protected by local by-law from potential RFI sources.

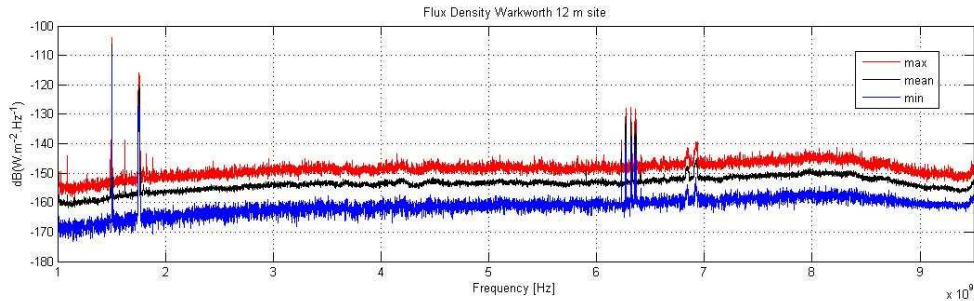

Figure 3. Result of RFI measurement at the Warkworth (New Zealand) site — flux density versus frequency (from 1 to 9 GHz). Three curves show maximal, minimal, and average (mean) levels of the radio noise floor (credit: Paul Banks, 2008).

The approximate (GPS) location of the antenna is  
 Latitude:  $-36^{\circ}26'05.3''$   
 Longitude:  $174^{\circ}39'47.7'' E$

### 3. Technical Information

The 12m Radio Telescope (RT) was manufactured by Patriot Antennas Inc. in Albion, Michigan, USA. The list below provides technical specifications for the high-frequency RTNF antenna:

- Diameter: 12.1 m
- Surface Accuracy: 0.3 mm (0.012 inches) rms.
- Frequency range: 2.1 - 32 GHz.
- Dual shaped Cassegrain,  $F/D = 0.375$  (primary surface)
- Directive efficiency: 85%
- Pointing Accuracy: 0.005 degree
- Operational temperature range: -15 to +55 deg C
- Specs apply in winds of 30 mph (50 km/h)
- 100 mph (160 km/h) survival in stow
- + 4.5 to 88 deg elevation travel
- +/- 270 degree azimuth travel
- Slew and scan rates
  - Up to 5 deg/s in Azimuth
  - Up to 1 deg/s in Elevation



The table below presents the major elements of the AUT e-VLBI receiving system and their current status.

- **Radio telescope.** Installation of the 12-m radio telescope was finished in October 2008. Preparation of the radio telescope for VLBI observations is in progress.
- **Feed.** The coaxial dual band (S and X) dual polarization (circular left/right) feed horn was specifically developed by Patriot Antennas and installed in the AUT 12-m radio telescope.
- **Low noise amplifiers.** Four MITEQ high-gain low-noise amplifiers (LNAs) are installed (for both S and X bands and both polarizations).
- **Receivers.** See details on the S-band and X-band receivers below.
- **Frequency Standard.** Symmetricom Active Hydrogen Maser MHM-2010 (75001-114) has three outputs @ 5 MHz, one output @ 10 MHz, one output @ 100 MHz, two outputs @ 1 pps (pulse per second) and a 1 pps sync. The above selection is the most comprehensive available and contains at least one of all available outputs. A separate distribution amplifier unit allows up to 15 outputs of the 10 MHz signal to be obtained.
- **Digitizer.** The AUT VLBI receiving system will use the digital base band converter (DBBC) developed at the Italian Institute of Radio Astronomy.
- **Recorder.** The AUT VLBI receiving system uses the Mark 5B+ data recorder developed at Haystack Observatory, MIT.

The S/X receiver developed for the AUT radio telescope is of a superheterodyne design; signals from the antenna feed being mixed with LO signals to produce an IF signal at lowered frequency before propagation along coax cable to the digitizing and recording instruments. The receiver is designed to be mounted directly at the feed of the antenna and provide sufficient gain to overcome losses in the approximately 65 meter cable run back to the Observatory Control Room and provide a signal of suitable level for the data recorder.

The receiver may be viewed as consisting of 4 separate signal chains that provide the necessary gain and selectivity for both left and right circular polarizations of the two frequency bands (S and X) output by the antenna feed. The design of the feed is provided in Figure 4.

A Phase Locked Oscillator (PLO) referenced to the Observatory Maser provides the necessary LO signals, 7.6 GHz for X band and 1.9 GHz for S band to mix the signals down to the chosen intermediate frequencies (IF).

In each signal chain a set of three LNAs provide a total gain of approximately 110 dB. It is anticipated that some additional gain may be necessary to adjust signal levels immediately prior to input to the digital recorder equipment once that has been received.

Injection of a phase calibration tone and noise calibration signal is provided via a directional coupler located at the front end of the receiver chain. These two systems will respectively allow phase response and sensitivity (gain) of the receiver to be periodically checked during the course of a VLBI experiment.

The receiver is of an uncooled design, and as such its temperature will vary with the natural temperature of the environment. Both the receiver components and the coaxial cable used to pipe signal off the antenna have some sensitivity to temperature that will introduce phase and gain variations to the receiver output. By switching in phase and noise calibration signals at regular intervals the variations of these quantities during an experiment may be logged and then modelled and compensated for during the VLBI correlation process.

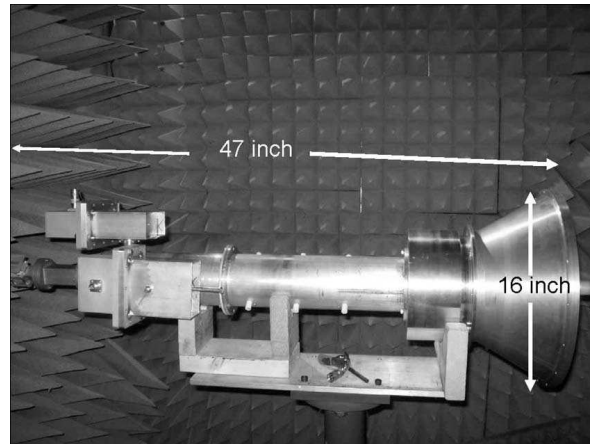

Figure 4. Dual band (S/X) dual polarization feed horn. Designed by Patriot Antennas.

#### 4. Co-located Facilities

New Zealand's traditional role in contributing to global reference frame determination is through its GNSS PositionNZ network operated by Land Information New Zealand in a partnership with the Geological and Nuclear Sciences Research Institute (GNS Science). The PositionNZ network consists of 33 GNSS continuously operating reference stations (CORS) in mainland New Zealand, one on the Chatham Island (400 km east of Christchurch) and three in Antarctica [4]. Data from several of these sites are forwarded to the International GPS Service (IGS) where they are incorporated into solutions used to determine GNSS satellite orbit and global reference frame determinations.

In November 2008 a new PositionNZ station was built at the AUT radio telescope site, and an accurate tie will be made between the radio telescope antenna and the GNSS antenna. Data from this site will also be forwarded to the IGS, where it will be used to enhance global reference frames, along with the data from the VLBI station. The data will also contribute to an International Association of Geodesy (IAG) initiative to establish a Global Geodetic Observing System (GGOS).

In order to determine and survey an accurate position for the invariant point of the antenna (the intersection of the azimuth and elevation axes), four geodetic monuments have been built in the vicinity of the antenna (15-20 m from its pedestal). They will also be used to accurately determine the space vector (and its covariance matrix) between the reference center of the radio telescope and the GNSS antenna's phase center. The expected linear accuracy of the invariant point position is 1 mm.

#### 5. Network Connectivity

With wide spread development of e-VLBI, the issue of broadband network connectivity becomes essential for both existing and emerging radio astronomical facilities.

Internationally, New Zealand's major broadband supplier is Southern Cross Cables Ltd—a commercial organization, which owns and operates the cable connecting New Zealand with Australia in the west and with the U.S. in the south-north direction. This is a multi-wavelength cable

with the capacity of several hundreds of Gbps.

Another networking company, Kordia, is planning to lay a 2 Tbps fiber between New Zealand and Australia in 2010.

Locally, the regional advanced network operating in New Zealand is KAREN (Kiwi Advanced Research and Education Network), which provides 10 Gbps connectivity between New Zealand's educational and research institutions. Currently KAREN is planning to establish a GigaPoP in Warkworth, which will provide the connection for the radio telescope. The last mile connection between the radio telescope and Warkworth (5 km) will be provided by Telecom via the cable that already exists between the Satellite Station and the township of Warkworth.

## 6. Education

The radio telescope will be operated by the AUT Institute for Radiophysics and Space Research (IRSR). Being a research tool for astronomy and geodesy, the antenna will also be used in a new educational program in astronomy just started at AUT's School of Computing and Mathematical Sciences—an Astronomy Major in the framework of the Bachelor of Mathematical Sciences degree. It is envisaged that both undergraduate and post-graduate students will use the radio telescope in their research projects and as a teaching resource in the courses taught at AUT, such as Astrophysics, Radio Astronomy, Practical Astrophysics, Space Geodesy, and others.

## References

- [1] Niell, A. et al., VLBI2010: Current and Future Requirements for Geodetic VLBI Systems. Report of Working Group 3 to the IVS Directing Board. 2005.
- [2] Gulyaev, S., Natusch, T., Tingay, S. and Deller A. Development of New Zealand radio astronomy and Trans-Tasman long-baseline array. *Southern Stars*, Vol. 44, No. 4, pp. 12–18, 2005.
- [3] Gulyaev, S., Natusch, T., Tingay, S., Deller, A., West, C., Ellingsen, S., McCulloch, P., Reid, B., Baynes, E. and Tzioumis, T. First steps towards radio astronomy in New Zealand. *ATNF News*, Issue 58, 2006.
- [4] [www.linz.govt.nz/positioNZ](http://www.linz.govt.nz/positioNZ)





IVS Coordination

**IVS Coordination**



# Coordinating Center Report

*Dirk Behrend*

## Abstract

This report summarizes the activities of the IVS Coordinating Center during the year 2008 and forecasts activities planned for the year 2009.

## 1. Coordinating Center Operation

The IVS Coordinating Center is based at the Goddard Space Flight Center and is operated by NEOS (National Earth Orientation Service), a joint effort for VLBI by the U.S. Naval Observatory and the NASA Goddard Space Flight Center.

The mission of the Coordinating Center is to provide communications and information for the IVS community and the greater scientific community and to coordinate the day-to-day and long-term activities of IVS.

The Web server for the Coordinating Center is provided by Goddard. The address is

<http://ivscc.gsfc.nasa.gov>

## 2. Activities during 2008

During the period from January through December 2008, the Coordinating Center supported the following IVS activities:

- Directing Board support: Coordinated, with local committees, two IVS Directing Board meetings, in St. Petersburg, Russia (March 2008) and Penticton, BC, Canada (September 2008). Notes from each meeting were published on the IVS Web site. Coordinated with the Election Committee the representative elections and published the results.
- Components: Supported the Call for Proposals for Combination Centers and Operational Analysis Centers.
- Communications support: Maintained the Web pages, e-mail lists, and Web-based mail archive files. Generated analysis reports and included them into the 24-hour session Web pages. Added Intensive session Web pages.
- Publications: Published the 2007 Annual Report in spring 2008. Published three editions of the IVS Newsletter in April, August, and December, 2008. In collaboration with the Institute of Applied Astronomy, published the Proceedings of the fifth IVS General Meeting in summer 2008. All publications are available electronically as well as in print form.
- 2008 Master Schedule: Generated and maintained the master observing schedule for 2008. Coordinated VLBI resources for observing time, correlator usage, and disk modules. Coordinated the usage of Mark 5 systems at IVS stations and efficient deployment of disk modules. Coordinated the continuous VLBI campaign 2008 (CONT08).
- 2009 Master Schedule: Generated the proposed master schedule for 2009 and received approval from the Observing Program Committee.

- Meetings: Coordinated, with the Local Committee, the fifth IVS General Meeting, held in St. Petersburg, Russia in March 2008. Chaired the Program Committee for the meeting.
- Observing Program Committee (OPC): Coordinated meetings of the OPC to monitor the observing program, review problems and issues, and discuss changes.

### 3. CONT08 Campaign

The Continuous VLBI Campaign 2008 (CONT08) was successfully observed during summer. Eleven IVS stations (see Figure 1) observed for 15 consecutive days at a rate of 512 Mbps in the time frame of August 12-26, 2008. The observing was done on the basis of UT days with each CONT08 day running from 0 UT to 24 UT. UT day observing is needed to make the most accurate combination and comparison of results from other techniques.



Figure 1. Geographical distribution of the 11 CONT08 stations.

The Coordinating Center, in collaboration with the OPC, was responsible for:

- the overall planning and coordination of the campaign,
- the media usage and shipment schedule, and
- the preparation of the detailed observing schedules and notes.

Unlike the CONT05 campaign, all CONT08 data are being correlated at one correlator: the Washington Correlator is processing the entire CONT08 campaign. This helped ease the logistical aspects regarding module handling for the correlators, stations, and shipping. Correlation is expected to be finalized in early 2009.

Another innovation with respect to the previous CONTs was the introduction of staggered station check times. The daily station checks (e.g., pointing) were decoupled from the change of schedules and were instead introduced at convenient and well-coordinated times for the stations (i.e., different daily check times for each station). In this way, it was possible to avoid complete ob-



servational gaps. Previously, daily check gaps (of e.g. 30-minute length) had resulted in unrealistic peaks in the sub-daily EOP time series derived from the CONT data.

More information about the CONT08 campaign can be found on the IVS Web site under the URL <http://ivscc.gsfc.nasa.gov/program/cont08>.

#### 4. Staff

The staff of the Coordinating Center is drawn from individuals who work at Goddard. The staff and their responsibilities are listed in Table 1.

Table 1. IVS Coordinating Center staff.

Name	Title	Responsibilities
Dirk Behrend	Director	Web site and e-mail system maintenance, Directing Board support, meetings, publications, session Web page monitoring
Cynthia Thomas	Operation Manager	Master schedule (current year), resource management and monitoring, meeting and travel support, special sessions
Frank Gomez	Web Manager	Web server administration, mail system maintenance, data center support, session processing scripts, mirror site liaison
Karen Bayer	General Programmer and Editor	Publication processing programs, LaTeX support and editing, session Web page support and scripts

#### 5. Plans for 2009

The Coordinating Center plans for 2009 include the following:

- Maintain IVS Web site and e-mail system; implement new station pages.
- Publish the 2008 Annual Report (this volume).
- Coordinate, with the local committee, the fifth IVS Technical Operations Workshop to be held at Haystack Observatory, USA in April 2009.
- Support Directing Board meetings in 2009.
- Coordinate the 2009 master observing schedule and IVS resources.

# Analysis Coordinator Report

*A. Nothnagel, S. Böckmann, T. Artz*

## Abstract

IVS analysis coordination issues in 2008 are reported here. Routine EOP combinations on the basis of datum-free normal equations have been continued. For this, it was necessary to compute a new realization of a terrestrial reference frame. Investigations have been carried out on certain quality aspects of the IVS EOP series.

## 1. General Issues

The “Ninth IVS Analysis Workshop” was held at the Institute of Applied Astronomy, St. Petersburg, Russia, on March 7, 2008, in connection with the Fifth IVS General Meeting. The workshop was attended by more than 40 participants who enjoyed being hosted by the IAA with an impressive look onto the still winterly Neva. More details on the workshop can be found in Nothnagel (2008a).

## 2. IVS Operational Data Analysis and Combination

The combination process for the two IVS EOP series (rapid and quarterly solutions) has been continued exclusively on the basis of datum-free normal equations in SINEX format. In 2008, six IVS Analysis Centers (BKG, DGFI, GSFC, IAA, OPA, and USNO) contributed to the IVS combined products by providing input in the correct format. The rapid solutions contain only R1 and R4 sessions, and new data points are added twice a week as soon as the SINEX files of the six IVS Analysis Centers are available. The SINEX file submissions should not be later than 48 hours after the correlation is completed. A Web page is automatically updated which states the timeliness of the latest submissions of the R1 and R4 sessions. As can be seen on this Web page, the timeliness requirement is still exceeded too often for various reasons in logistics and personnel.

For the quarterly solution, updated every three months, almost all available data of 24-hour sessions from 1984 onwards are used. Since this series is designed for EOP determinations, those sessions are excluded which are observed with networks of limited extension or which are scheduled for a different purpose like radio source monitoring.

The advantages of the new combination strategy are (1) that the full variance-covariance information of the individual input solutions is rigorously carried over and (2) that one common terrestrial reference frame is applied after the combined datum-free normal matrix is generated. Thus, it is guaranteed that an identical datum is used in the combination process for all input series.

After datum definition, the combined system of normal equations is solved (inverted), and the full set of EOP (pole components, UT1–UTC, and their time derivatives as well as two nutation offsets in  $d\psi$  and  $d\varepsilon$  w.r.t. the IAU2000A model) are extracted into separate files. These results are then added to the two EOP time series, the rapid solution file (*ivs08r1e.eops*), and the quarterly solution file (*ivs08q4e.eops*), in the IVS EOP Exchange format. Companion files containing the nutation offsets in the X, Y paradigm are routinely generated through a standard transformation process (*ivs08r1X.eops*, *ivs08q4X.eops*).

### 3. VTRF2008

In 2008, it became obvious that a new TRF for the IVS EOP determinations had to be computed for several reasons. ITRF2005, used in 2007 and 2008, has a noticeable deficit due to the pole tide error which had been made in the IVS contribution to ITRF2005. The post-quake movements of GILCREEK in ITRF2005 lacked the continuity of the piece-wise linear elements, thus, introducing discontinuities. In addition, for the sites of SVETLOE, ZELENCHK, and BADARY, either only limited observations had been available for ITRF2005 or no observations had been available yet. Of course, all other stations took their benefit from more data in the new computations as well.

The new TRF (VTRF2008) has been computed from the individual combined SINEX files of all geodetic VLBI sessions available. These have been pre-reduced for EOP so that only the coefficients for the site coordinate parameters remained. In a stacking process, these sets of normal equations have then been combined to a full TRF normal equation system for site positions and velocities. The subsequent inversion process provided the complete TRF including its variance-covariance information. VTRF2008 is being used for all combinations since December 2008.

### 4. Station Irregularities

In the process of quality control, Volker Tesmer detected first that the estimates of the vertical component of the SESHAN25 site position exhibited a jump of up to 70 mm downwards (Fig. 1). Several tests have been made to determine from where this jump originates. Unfortunately, no conclusive explanation has been found so far.

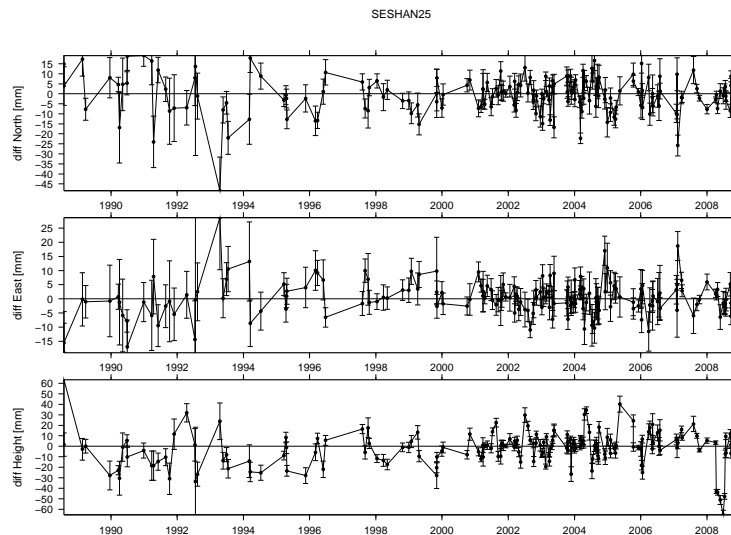

Figure 1. Time series of SESHAN25 site position

After about five months, the position has jumped back again to its original position. This is particularly puzzling but should help to find the reason for this jump.

## 5. Thermal Expansion of Radio Telescopes

Thermal expansion effects have been considered already for a long time but concerted activities to include it in IVS data analysis have only started in 2008. At the Ninth IVS Analysis Workshop in St. Petersburg, it was decided to make thermal expansion modeling the first chapter of the IVS Analysis Conventions. This should serve as a proper reference for all analysis descriptions. In addition, a decision was made to use the GPT model (Boehm et al. 2007) to compute the reference temperature for each telescope. Any expansion effect can and should now be computed relative to these mean temperatures. In the meantime, the current status of thermal expansion modelling has been documented in a refereed paper (Nothnagel, 2008b) which is the written documentation of Chapter 1 of the IVS Analysis Conventions.

One of the necessary parts of a model for expansion effects is a list of all telescopes' construction dimensions. In such a list, all dimensions like effective height of the elevation axis above the ground for azimuth-elevation telescopes or height of primary axis above secondary axis for polar or XY antennas, just to name a few, have to be tabulated for all telescopes. Quite some effort has been invested to collect the information for this list, and further efforts are still necessary to gather the missing information for a few more telescopes. The list is available under <http://vlbi.geod.uni-bonn.de/IVS-AC/Conventions> together with the reference paper.

Since the reference temperatures of all telescopes are long-term means from a model, no effective change in the realizations of terrestrial reference frames are expected. However, annual variations in station coordinates, especially in the height component, are expected to reduce. Consequently, Earth orientation parameters from VLBI observations may also be affected, mainly with an annual signature.

## 6. Personnel

Table 1. Personnel at the IVS Analysis Coordinator's office

Axel Nothnagel	+49-228-733574	nothnagel@uni-bonn.de
Sarah Böckmann	+49-228-733563	boeckmann@uni-bonn.de
Thomas Artz	+49-228-733563	thomas.artz@uni-bonn.de

## References

- [1] Boehm J, Heinkelmann R, Schuh H (2007) Short note: a global model of pressure and temperature for geodetic applications. *J Geod* 81: 679–683. doi:10.1007/s00190-007-0135-3
- [2] Nothnagel A (2008a) Notes of the Ninth IVS Analysis Workshop. In: International VLBI Service for Geodesy and Astrometry, “Measuring the Future”, Proceedings of the Fifth IVS General Meeting, A. Finkelstein and D. Behrend (Eds.), Saint Petersburg, Nauka, 465–467
- [3] Nothnagel A (2008b) Conventions on thermal expansion modelling of radio telescopes for geodetic and astrometric VLBI. *J Geod*, DOI 10.1007/s00190-008-0284-z

# Network Coordinator Report

*Ed Himwich*

## Abstract

This report includes an assessment of the network performance in terms of lost observing time for the 2008 calendar year. Overall, the observing time loss was about 15.1%, an increase of about 3.7% from the previous year. A table of relative incidence of problems with various subsystems is presented. The most significant identified causes of loss were antenna reliability (accounting for about 19.2%), RFI (14.8%), and receiver problems (13.8%), Unidentified problems accounted for about 17.7% of the loss. There are prospects for Korea, India, and New Zealand to start contributing to IVS. New antennas are being purchased by Australia and New Zealand.

## 1. Network Performance

The network performance report is based on correlator reports for experiments in calendar year 2008. This report includes the 155 24-hour experiments that had detailed correlator reports available as of March 23, 2009. Results for 29 experiments were omitted because either they were correlated at the VLBA, they have not been correlated yet, or correlation reports were not available on the IVS data centers. Experiments processed at the VLBA correlator were omitted because the information provided is not as detailed as from Mark IV correlators. The experiments that have not been correlated yet include mostly RD, JD, and T2 experiments from the second half of the year, as well as some OHIG experiments. In summary, roughly 85% of the scheduled experiments for 2008 are included in this report.

An important point to understand is that in this report the network performance is expressed in terms of lost observing time. This is straightforward in cases where the loss occurred because operations were interrupted or missed. However, in other cases, it is more complicated to calculate. To handle this, a non-observing time loss is typically converted into an equivalent lost observing time by expressing it as an approximate equivalent number of recorded bits lost. As an example, a warm receiver will greatly reduce the sensitivity of a telescope. The resulting performance will be in some sense equivalent to the station having a cold receiver but observing for (typically) only one-third of the nominal time and therefore recording the equivalent of only one-third of the expected bits. In a similar fashion, poor pointing can be converted into an equivalent lost sensitivity and then equivalent fraction of lost bits. Poor recordings are simply expressed as the fraction of total recorded bits lost.

Using correlator reports, an attempt was made to determine how much observing time was lost at each station and why. This was not always straightforward to do. Sometimes the correlator notes do not indicate that a station had a particular problem, while the quality code summary indicates a significant loss. Reconstructing which station or stations had problems—and why—in these circumstances does not always yield accurate results. Another problem was that it is hard to determine how much RFI affected the data unless one or more channels were removed and that eliminated the problem. It can also be difficult to distinguish between BBC and RFI problems. For individual station days, the results should probably not be assumed to be accurate at better than the 5% level.

The results here should not be viewed as an absolute evaluation of the quality of each station's performance. As mentioned above, the results themselves are only approximate. In addition, some

problems are beyond the control of the station, such as weather and power failures. Instead the results should be viewed in aggregate as an overall evaluation of what percentage of the observing time the network is collecting successfully. Development of the overall result is organized around individual station performance, but the results for individual stations do not necessarily reflect the quality of operations at that station.

Since stations typically observe with more than one other station at a time, the average lost observing time per station is not equal to the overall average loss of VLBI data. Under some simplifying assumptions, the average loss of VLBI data is roughly about twice the average loss of observing time. This approximation is described in the Network Coordinator's section of the IVS 2001 Annual Report.

For the 155 experiments from 2008 examined here, there are 1,121 station days or about 7.2 stations per experiment on average. Of these experiment days about 15.1% (or about 169 days) of the observing time was lost. For comparison to earlier years, see Table 1.

Table 1. Lost observing time

<b>Year</b>	<b>Percentage</b>
1999-2000*	11.8
2001	11.6
2002	12.2
2003	14.4
2004	12.5
2005	14.4
2006	13.6
2007	11.4
2008	15.1

\* The percentage applies to a subset of the 1999-2000 experiments.

The lost observing time for 2008 was more than for 2007 and all other previous years. It is not clear whether the year-to-year variations in lost observing time reflect real changes in the performance level or simply variations due to inaccuracies in the analysis method. It does seem, however, that despite the approximations in the analysis method, the calculated observing time loss has been running fairly consistently at the 12-14% level for several years. The breakdown of the causes of these losses is discussed below. If the observing time losses are converted into VLBI data yield losses, then 2008 had about a 30% VLBI data loss.

It should be noted that in the CONT05 experiments in 2005, where a special effort was made to achieve high reliability at some of the most reliable stations in the network, an observing time loss of only 4.0% was achieved for 165 scheduled station days. The performance during CONT08 was not as good, primarily due to LO, RFI, and rack problems for the 165 scheduled station days; about 9.3% of the observing time was lost.

An assessment of each station's performance is not provided in this report. While individual station information was presented in some previous years, this practice seemed to be counter-productive. Although many caveats were provided to discourage people from assigning too much significance to the results, there was feedback that suggested that the results were being over-

interpreted. Additionally, some stations reported that their funding could be placed in jeopardy if their performance appeared bad even if it was for reasons beyond their control. Last and not least, there seemed to be some interest in attempting to “game” the analysis methods to improve the individual results. Consequently, only summary results are presented here. Detailed results are presented to the IVS directing board. Each station can receive the results for their station by contacting the Network Coordinator (Ed.Himwich@nasa.gov).

For the purposes of this report, the stations were divided into two categories: **large N**: those that were included in 18 or more network experiments among those analyzed here, and **small N**: those in 10 or fewer (no stations were in 11-17 experiments). The distinction between these two groups was made on the assumption that the results would be more meaningful for the stations with more experiments. The average observing time loss from the large N group was much smaller than the average from the small N group, 14.4% versus 23.2%. The losses for both groups were larger than in previous years. There are many fewer station days in the small N group than the large N group, 93 versus 1028, so the large N group is dominant in determining the overall performance.

There are 16 stations in the large N group. Eight stations observed in 65 or more experiments. Of the 16, five stations successfully collected data for approximately 90% of their expected observing time. Six more stations collected 80% or more of the time. Three more stations collected data for more than 70% of their observing time. Two stations of the 16 collected data slightly less than 70% of their scheduled observing time. These statistics are not much worse than last year’s. There is a difference though in that there are more station days among the stations that lost the highest percentage of observing time, whereas in the past the stations with more station days have been the stations that typically lost the lowest percentage of observing time.

There are 19 stations in the small N group. The range of lost observing time for stations in this category was 0%-57%. The median loss rate was about 15%, much worse than last year.

The losses were also analyzed by sub-system for each station. Individual stations can contact the Network Coordinator (Ed.Himwich@nasa.gov) for the sub-system breakdown (and overall loss) for their station. A summary of the losses by sub-system (category) for the entire network is presented in Table 2. This table includes results since 2003 sorted by decreasing loss in 2008.

Table 2. Percentage observing time lost by sub-system

Sub-System	2008	2007	2006	2005	2004	2003
Antenna	19.2	34.6	19.0	24.4	32.9	17.8
Unknown	17.7	14.9	4.0	3.3	10.1	12.6
RFI	14.8	10.4	11.6	6.2	5.0	9.3
Receiver	13.8	14.9	20.8	24.2	18.0	25.2
Miscellaneous	12.8	7.6	18.0	8.0	8.0	6.0
Rack	8.7	11.4	16.3	5.1	6.8	5.0
Shipping	5.4	1.0	0.0	0.2	1.4	6.1
Recorder	4.1	4.6	3.3	8.9	11.1	10.9
Operations	2.3	0.0	2.0	4.7	6.1	3.6
Clock	0.5	0.3	4.9	14.5	0.5	3.4
Software	0.1	0.4	0.1	0.5	0.1	0.1

The categories in Table 2 are rather broad and require some explanation, which is given below.

**Antenna** This category includes all antenna problems including mis-pointing, antenna control computer failures, non-operation due to wind, and mechanical breakdowns of the antenna.

**Clock** This category includes situations where correlation was impossible because the clock offset either was not provided or was wrong, leading to “no fringes”. Maser problems and coherence problems that could be attributed to the Maser were also included in this category. Phase instabilities reported for Kokee were included in this category.

**Miscellaneous** This category includes several small problems that do not fit into other categories, mostly problems beyond the control of the stations, such as power, (non-wind) weather, cables, and errors in the observing schedule provided by the Operation Centers. Starting with 2006, this category also includes errors due to tape operations at the stations that were forced to use tape because either they didn’t have a disk recording system or they did not have enough media. There were no tape operations in 2008. Tape operation has now ended. This category is dominated by power and weather issues.

**Operations** This category includes all operational errors, such as DRUDG-ing the wrong schedule, starting late because of shift problems, operator (as opposed to equipment) problems changing recording media, and other problems.

**Rack** This category includes all failures that could be attributed to the rack (DAS) including the formatter and BBCs. There is some difficulty in distinguishing BBC and RFI problems in the correlator reports, so that some losses are probably mis-assigned between these categories.

**Receiver** This category includes all problems related to the receiver including outright failure, loss of sensitivity because the cryogenics failed, design problems that impact the sensitivity, LO failure, and loss of coherence that was due to LO problems. In addition, for lack of a more clearly accurate choice, loss of sensitivity due to upper X band Tsys and roll-off problems were assigned to this category.

**Recorder** This category includes problems associated with data recording systems. Starting with 2006, no problems associated with tape operations are included in this category.

**RFI** This category includes all losses directly attributable to interference including all cases of amplitude variations in individual channels, particularly at S-band. There is some difficulty in distinguishing BBC and RFI problems in the correlator reports, so that some losses are probably mis-assigned between these categories.

**Shipping** This category includes all observing time lost because the media were lost in shipping or held up in customs or because problems with electronic transfer prevented the data from being correlated with the rest of the experiment’s data.

**Software** This category includes all instances of software problems causing observing time to be lost. This includes crashes of the Field System, crashes of the local station software, and errors in files generated by DRUDG.

**Unknown** This category is a special category for cases where the correlator did not state the cause of the loss and it was not possible to determine the cause with a reasonable amount of effort.



Despite the notable antenna and receiver problems during the year, the combined losses due to these two sub-systems was only about 33%, down from the more typical value of about 50% that was seen in previous years. This is primarily due to a reduction in antenna related losses. Most notably, Svetloe and Zelenchukskaya had greatly improved antenna reliability. On the other hand, Fortaleza and HartRAO suffered significant non-typical problems. For 2008 the stations with significant antenna problems include Fortaleza, Zelenchukskaya, and HartRAO.

It should be noted that HartRAO, perennially one of the best performing stations, suffered a catastrophic antenna failure in October 2008. It is unknown when or if the antenna will return to operation, but it does not appear to be likely for 2009. The statistics reported here include antenna related losses for approximately six weeks after the antenna failed. After that, for the remaining approximately six weeks in 2008, HartRAO was no longer scheduled in any experiments.

Stations with significant receiver problems include Ny-Ålesund, TIGO, Westford, and Fortaleza. The most significant problems were LO and cryogenic failures. The harsh conditions at Ny-Ålesund can prevent timely receiver repair.

The “Unknown” category loss is larger this year than the previous year, which was already higher than the level in years before that. This would appear to be due to the correlators being under increasing resource pressure and therefore not being free to chase down the cause of every little problem. It is also extremely time consuming to do this when constructing this report. An effort will be made to get more information included up-front in the stations’ reports to help reduce this lack of information for next year’s report. The impression created by the pattern of unknown losses does not suggest that it is particularly due to antenna problems.

The “Miscellaneous” category loss is larger than last year and worse than the results in all other years except one. This year there were several weather related losses and cable problems. The cable problems occurred primarily at Ny-Ålesund; the harsh conditions at Ny-Ålesund can prevent timely repair of outdoor cabling. This category is a “grab bag”. More specific categories will be used for next year’s report.

The “Rack” category loss was smaller this year than for the previous one. This is due to the rack at Seshan being fully populated due to a loan of modules by NASA. There has been some improvement in the BBC situation at Zelenchukskaya and Badary as well. Some of the decrease may be due to the difficulty in distinguishing BBC and RFI problems in the correlator reports, so that some losses are mis-assigned. This has probably been a problem for previous years as well.

The “RFI” category loss level is higher than in previous years. No doubt this is at least partly due to increasing RFI levels, particularly at European stations. However at least some of increase may be due, as mentioned above, to mis-assigning the losses due to BBC and RFI. The station with the most significant RFI problem continues to be Matera.

The “Clock” category continued the low loss level seen last year. There were no major Maser failures or other timing problems this year.

The “Recorder” category continued its low loss level from the two previous years. The decrease in observing time loss due to recorder operations from about 11% to about 4% probably represents the “disk dividend” we have been hoping to get as tape use has been eliminated.

The “Shipping” category has significantly more loss than in previous years, primarily because of customs difficulties in getting modules to Fortaleza.

In summary, there is no specific sub-system to point to for the increase in losses in 2008. There were general increases in “Unknown”, “Miscellaneous”, “RFI”, and “Shipping” problems. On the other hand there were decreases in “Antenna” and “Rack” problems.

## 2. New Stations

There are prospects for new stations on several fronts. Both Australia and New Zealand are in the process of obtaining and commissioning new antennas—three and one, respectively. Korea is planning to build one antenna primarily for geodesy. There is also interest in using the Korean VLBI Network (KVN), which will consist of three stations intended primarily for astronomy, for geodesy. There is interest in India in building a network of four telescopes that would be useful for geodesy. Many of these antennas may become available for use in the next few years. Efforts are being made to ensure that these antennas will be compatible with VLBI2010.

# IVS Technology Coordinator Report

*Alan Whitney*

## Abstract

In 2008 the Technology Coordinator was active in the following areas: 1) support of work to implement a new geodetic VLBI system as outlined in the IVS Working Group 3 “VLBI2010” study, 2) continued development and deployment of e-VLBI, 3) organization of the 7th Annual e-VLBI Workshop held at Shanghai Observatory in Shanghai, China, and 4) development of the VLBI Data Interchange Format (VDIF) specification. We will briefly describe each of these activities.

## 1. VLBI2010 Progress

Progress continues towards the goal of a next-generation geodetic VLBI system. Some of the highlights are described in the following.

### 1.1. Development of the VLBI2010 Broadband System

A collaboration of Haystack Observatory, NASA/GSFC, and HTSI has implemented the first demonstration broadband systems on the 18 m antenna at Westford, MA, and on the 5 m MV-3 antenna at NASA/GSFC. Significant progress was made in 2008.

In the past year

- phase cal was added;
- a new digital phase cal was designed and tested and is ready for installation;
- RF filters were installed in the Dewar to reduce the effect of interference below 3.1 GHz;
- DBEs were improved;
- the complete broadband system was installed at both sites;
- fringes were obtained from 3.4 to 9 GHz.

Some problems remain.

- MV-3 has low efficiency due at least partly to an incorrectly shaped sub-reflector.
- The focus setting needs to be optimized at Westford.

For more details see the Haystack Technology Development Center report in this volume.

### 1.2. VLBI2010 Studies

A progress report on the status of VLBI2010 development has been completed [1]. In it are included the recommendations for antenna specifications and the results of the simulations that have led to these recommendations.

### 1.3. DBE2/Mark 5C

A next generation of digital back end (DBE2) and recorder (Mark 5C) are under development at Haystack Observatory [2]. Two important features of this system are a) the ability to record at 4096 Mbps and b) communication via 10 Gbps Ethernet.

In the past year the DBE2 board was completed and received at Haystack Observatory. The board was powered up, and initial communication was achieved. Much of the digital signal processing firmware has been simulated, and programming of the Power PC is about to begin.

The Mark 5C is derived from a Mark 5B+ by the addition of a daughter board containing the 10 GigE interface and the deletion of the I/O board. The daughter board has recently been completed and tested, thus enabling testing of communication between the DBE2 and the Mark 5C.

## 2. e-VLBI Development

### 2.1. Continued Expansion and Development of Routine e-VLBI Data Transfers

All data recorded on the Japanese K5 systems are now e-transferred from Tsukuba or Kashima to either MPI or Haystack, depending on the target correlator. K5 modules from the Antarctic site of Syowa and the sites of the smaller Japanese antennas are shipped to Tsukuba, transferred over the network to Haystack, converted from K5 to Mark 5 format in the transfer process, and written on Mark 5 modules. UT1 Intensive data from Wettzell, Japan, and Ny-Ålesund are transferred to either MPI or to a site near the Washington correlator (where the last couple of km is currently via sneakernet!), depending on the target correlator for the data.

Welcome news! The station at Fortaleza, Brazil, is now connected, and tests are on-going. The Mark IV correlator at USNO in Washington, D.C., will be connected to high-speed fiber (~600 Mbps) sometime early 2009. In addition, we expect that the Kokee station will also be connected to high-speed network sometime early in 2009, initially at ~100 Mbps. These connections should help to significantly reduce the latency for the time-critical processing of UT1 data from days to hours.

### 2.2. 7th International e-VLBI Workshop Held at Shanghai, China

The 7th International e-VLBI Workshop was held 16-17 June 2008 in Shanghai, China, hosted by the Shanghai Astronomical Observatory. The workshop was attended by 87 participants from 11 countries.

Presentations at the workshop showed continuing progress in e-VLBI on several fronts. In Europe the JIVE EXPReS project continues to connect European astronomical VLBI telescopes in real-time and conducts regular scientific e-VLBI experiments with up to six stations at data rates nearing 1 Gbps/station. Australia continues to make rapid progress in connecting its telescopes and has also developed a software correlator system to support real-time observations.

At the end of each day a panel discussion was held following the presentation sessions. The panel discussion on the first day was on e-VLBI funding and organization. On the second day, a lively discussion took place about data formats, transfer protocols, and related issues, which led to the formation of a task force to study these issues (see below).

The workshop also featured two e-VLBI demonstrations, the first involving the Chinese VLBI Network (e-CVN) using four telescopes (Sheshan, Urumqi, Beijing, and Kunming) demonstrating the near-real-time mode used to track the Chang'E spacecraft during its flight to the moon in October 2007. The second demonstration collected and correlated (via software correlator) data from a variety of telescopes in China, Japan, and Australia, using global high-speed networks over a 12-hour period at data rates of 256 Mbps and 512 Mbps.

All presentations from the Shanghai workshop are available at:

*<http://www.shao.ac.cn/eVLBI2008/presentation/>*.

The 8th International e-VLBI Workshop, titled “Science and Technology of Long Baseline Real-time Interferometry”, will be held 22-26 June 2009 in Madrid, Spain, sponsored by CNIG-IGN of Spain and the EXPReS project. We all look forward to another valuable and stimulating meeting.

### **3. VLBI Data Interchange Format (VDIF) Task Force**

One important outcome of the 7th International e-VLBI Workshop was the creation of a task force to study and recommend a universal VLBI data format that is suitable for both on-the-wire e-VLBI data transfer, as well as direct disk storage. This task force, called the VLBI Data Interchange Format (VDIF) Task Force, is envisioned as the first of a two-part effort, the second of which will address standardization of e-VLBI data transmission protocols. The formation of the VDIF Task Force was prompted particularly by the increased e-VLBI activity and the difficulties encountered when data arrive in different formats from various instruments and various parts of the world. Appointed to the VDIF Task Force were Mark Kettenis (JIVE), Chris Phillips (ATNF), Mamoru Sekido (NICT), and Alan Whitney (MIT Haystack, chair). The VDIF group has been very active; a final report to the VLBI community is expected in early 2009.

### **References**

- [1] Petrachenko, W.T., et al., Design Aspects of the VLBI2010 System, Progress Report of the IVS VLBI 2010 Committee, this volume, 2009.
- [2] Whitney, A., A. Niell, Haystack Technology Development Center Report, In: International VLBI Service for Geodesy and Astrometry 2007 Annual Report, NASA/TP-2008-214162, D. Behrend and K. D. Baver (eds.), 253-256, 2008.





## Network Stations



# Network Stations





# Badary Radio Astronomical Observatory

*Sergey Smolentsev, Roman Sergeev*

## Abstract

This report provides information about the Badary network station: general information, facilities, staff, present status and outlook.

## 1. General Information

The Badary Radio Astronomical Observatory (BdRAO) was founded by the Institute of Applied Astronomy (IAA) as one of three stations of the Russian VLBI network QUASAR [1]. The sponsoring organization of the project is the Russian Academy of Sciences (RAS). The Badary Radio Astronomical Observatory is situated in the Burytia Republic (East Siberia) about 130 km east of Baikal Lake (see Table 1). The geographic location of the observatory is shown on the IAA RAS [3] Web site. The basic instruments of the observatory are a 32-m radio telescope (see Fig. 1) and technical systems for making VLBI observations.



Figure 1. Badary Observatory.

Table 1. Badary Observatory location and address.

Longitude	102°14'
Latitude	51°46'
Badary Observatory Republic Burytia 671021, Russia sergeev@ipa.nw.ru	

## 2. Technical and Scientific Information

The Badary station equipment includes the following main components: a 32-m radio telescope equipped with low noise receivers, a frequency and time keeping system with H-masers CH1-80 and CH1-80M, a local geodetic network, a GPS receiver Leika SR 520 (geodetic) and a GPS/GLONASS K161 receiver (for synchronization of the time keeping system), a data acquisition system R1001 [2], Mark 5B and S2 recording terminals, and automatic meteorological station WXT510 (Vaisala). Characteristics of the radio telescope are presented in Table 2.

The Badary Observatory was connected with main line optical fiber glass.

Table 2. Technical parameters of the radio telescope.

Year of construction	2005
Mount	AZEL
Azimuth range	$\pm 270$ (from south)
Elevation range	from $-5^\circ$ to $95^\circ$
Maximum azimuth	
- velocity	$1.5^\circ/\text{s}$
- tracking velocity	$1.5'/\text{s}$
- acceleration	$0.2^\circ/\text{s}^2$
Maximum elevation	
- velocity	$0.8^\circ/\text{s}$
- tracking velocity	$1.0'/\text{s}$
- acceleration	$0.2^\circ/\text{s}^2$
Pointing accuracy	better than $10''$
Configuration	Cassegrain (with asymmetrical sub-reflector)
Main reflector diameter	32-m
Sub-reflector diameter	4 m
Focal length	11.4 m
Main reflector shape	quasi-paraboloid
Sub-reflector shape	quasi-hyperboloid
Surface tolerance of main reflector	$\pm 0.5$ mm
Frequency capability	1.4–22 GHz
Axis offset	2.5 mm $\pm 0.5$ mm

## 3. Technical Staff

Roman Sergeev — Observatory chief,  
 Nicolay Mutovin — FS, pointing system controls,  
 Alexander Seryh — front end and receiver support.

#### 4. Co-location with GPS

A permanent GPS receiver Leica SR520 was installed at Badary during April 2005. The accuracy of the local geodetic network (LGN) is about 2 mm. The LGN includes ten reference points presented in Fig. 2. 304 and 306–309 are ground markers. 301 and 312 are located on the roof of the laboratory building and are intended for the installation of GPS/GLONASS and DORIS antennas. 310 is the intersection of the radio telescope axes, and 311 is an intermediate marker on the azimuthal platform of the radio telescope.

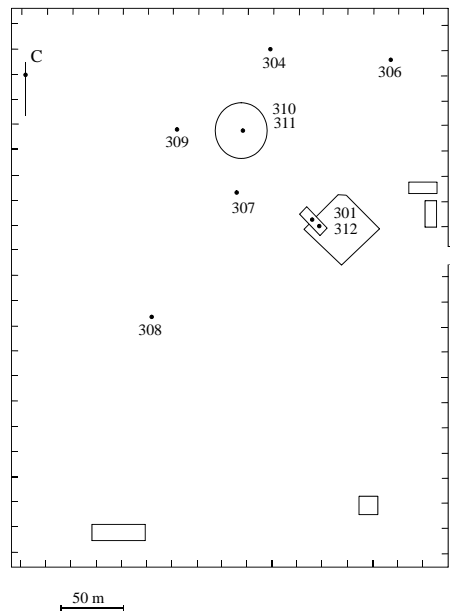

Figure 2. Local geodetic network at Badary Observatory.

#### 5. Participation in IVS Observing Programs

During 2008 the Badary IVS station participated in 42 IVS sessions as shown in Table 3: 7 IVS-R1, 34 IVS-R4 and 1 IVS-T2.

#### 6. Outlook

Our plans for the coming year are the following:

- Participation in 60 IVS observing sessions: IVS-R1, IVS-R4, IVS-T2, IVS-R&D and EURO.
- Participation in 24 domestic observational sessions for obtaining Earth orientation parameters.
- Surveying the local geodetic network.

Table 3. List of IVS sessions observed at BdRAO in 2008.

Month	IVS-R1	IVS-R4	T2
January	1	2	
February	1	1	
March		3	
April	1	5	
May	1	4	
June	2	2	
July	1	2	
August		2	
September		4	
October		2	
November		4	1
December		3	
Total	7	34	1

## References

- [1] Finkelstein A., Ipatov A., Smolentsev S. Radio Astronomy Observatories Svetloe, Zelenchukskaya and Badary of VLBI Network QUASAR. In: IVS 2004 General Meeting Proceedings, eds. N. R. Vandenberg, K. D. Baver, NASA/CP-2004-212255, 2004. pp. 161–165.
- [2] Fedotov L., Ivanov D., Ipatov A., Ipatova I., Lavrov A., Kosobokov M., Mikhailov A. Institute of Applied Astronomy Technology Development Center. In: IVS 2006 Annual Report, eds. D. Behrend, K. D. Baver, NASA/TP-2007-214151, 2007. pp. 255–258.
- [3] <http://www.ipa.nw.ru/PAGE/koi8-r/DEPOBSERV/rus>.

## Fortaleza Station Report for 2008

*Pierre Kaufmann, A. Macílio Pereira de Lucena, Adeildo Sombra da Silva,  
Claudio E. Tateyama, Avicena Filho, Carlos Fabiano B. Moreira*

### Abstract

This is a brief report about the activities carried out at the Fortaleza geodetic VLBI station (ROEN: Rádio Observatório Espacial do Nordeste), located in Eusébio, CE, Brazil, in 2008. The observing activities consisted of 79 VLBI sessions and continuous GPS monitoring recordings. The installation of optical fiber was completed, and the station switched to a 1 Gbit/s high speed network, to be used in e-VLBI operations. Regular GPS observations were carried out at the same site.

### 1. General Information

The Rádio Observatório Espacial do Nordeste, ROEN, located at INPE facilities in Eusébio, nearly 30 km east of Fortaleza, Ceará State, Brazil, began operations in 1993. Geodetic VLBI and GPS observations are carried out regularly, as contributions to international programs and networks. ROEN is part of the Brazilian space geodesy program, which was initially conducted by CRAAE (a consortium of the Brazilian institutions Mackenzie, INPE, USP, and UNICAMP) in the early 1990s. The program began with antenna and instrumental facilities erected, with activities sponsored by the U.S. agency NOAA and the Brazilian Ministry of Science and Technology's FINEP agency. ROEN is currently coordinated by CRAAM, Center of Radio Astronomy and Astrophysics, Engineering School, Mackenzie Presbyterian University, São Paulo, in agreement with the Brazilian National Space Research Institute, INPE. The activities are currently carried out under an Agreement of Cooperation signed between NASA—representing research interests of NOAA and USNO—and the Brazilian Space Agency, AEB, lasting until 2011. Under the auspices of the NASA-AEB Agreement, a contract was signed between NASA and CRAAM, Mackenzie Presbyterian Institute and University to partially support the activities at ROEN. The counterpart of the operational costs, staff, and infrastructure support are provided by INPE and by Mackenzie.



Figure 1. Fortaleza's 14.2 m antenna.

## 2. Component Description

The largest instrument of ROEN is the 14.2 m radio telescope, an alt-azimuth positioner. It is operated at S- and X-bands, using cryogenic radiometers. The system is controlled by the Field System, Version 9.9.2. Observations are recorded with a Mark 5 system. One Sigma-Tau hydrogen maser clock standard is operated at ROEN. GPS monitoring is performed within a cooperative program with NOAA (USA). There is a Leica System 1200 installed at the station that operates continuously. The collected data are provided to the NOAA/IGS center and to the Brazilian IBGE center. ROEN has all basic infrastructures for mechanical, electrical, and electronic maintenance of the facilities.



Figure 2. Fortaleza station control rack.

## 3. Staff

The Brazilian space geodesy program is coordinated by Prof. Pierre Kaufmann, who is Brazil AEB representative in the NASA-AEB Agreement. The coordination receives support from the São Paulo office at CRAAM/Instituto and Universidade Presbiteriana Mackenzie, with scientific assistance from Dr. Claudio E. Tateyama and partial administrative support from Valdomiro S. Pereira and Neide Gea Escolano. Partial technical assistance is occasionally given by technical staff from the Itapetinga Radio Observatory near São Paulo, also operated by INPE/Mackenzie. The Fortaleza Station facilities and geodetic VLBI and GPS operations are managed on site by Dr. A. M. P. de Lucena (CRAAE/INPE), assisted by Eng. Adeildo Sombra da Silva (CRAAE/Mackenzie), and technicians Avicena Filho (CRAAE/INPE) and Carlos Fabiano B. Moreira (CRAAE/Mackenzie).

## 4. Current Status and Activities

### 4.1. VLBI Observations

Fortaleza participated in geodetic VLBI experiments as detailed in table 1 for the year 2008.

Table 1. 2008 session participation.

Experiment	Number of Sessions
IVS-R1	26
IVS-R4	35
IVS-T2	04
IVS-CRF	03
IVS-OHIG	04
IVS-CRMS	03

## 4.2. Development and Maintenance Activities in 2008

Considerable attention was given to technical maintenance, especially to the following activities: 1) Maintenance of the cryogenic system, 2) Replacement of Mark IV power supplies, 3) Repairs of Mark IV video converters and the Mark IV IF3 Distributor module, 4) Repair of the UPS system, 5) Maintenance of the Web site (<http://www.roen.inpe.br>) and the local server computer, 6) Repair and adjustment of the receiver telemetry system, 7) Update of the Mark 5 operational system and software, and 8) Repair and alignment of elevation motor drives.

## 4.3. GPS Operations

The IGS network GPS receiver operated regularly at all times during 2008. Data were collected and uploaded to an IGS/NOAA computer.



Figure 3. Leica GPS receiver.

## 4.4. High Speed Network

During 2008, performance tests were implemented between the Fortaleza/Eusébio (ROEN) station, RNP (Rede Nacional de Pesquisas - Brazil National Research Network) and Haystack Observatory, with 200 Mbps and 90 Mbps data rates being obtained, respectively. Some intercon-

nection problems were detected and are being solved to improve that performance to at least 1 Gbps.



Figure 4. High speed network switch.

## 5. Future Plans

The optimized high speed optical network connection will allow ROEN to participate in e-VLBI experiments. The tests for the improvement of the network data rates are currently being carried out.

## 6. Acknowledgements

These activities have received partial support from NASA, within an agreement with the Brazilian Space Agency (AEB) and a contract with Mackenzie, as part of an agreement between Mackenzie INPE.



# Goddard Geophysical and Astronomical Observatory

*Jay Redmond, Irv Diegel*

## Abstract

This report summarizes the technical parameters and the technical staff of the VLBI system at the fundamental station GGAO. It also gives an overview about the VLBI activities during the previous year. The outlook lists the outstanding tasks to improve the performance of GGAO.

## 1. GGAO at Goddard

The Goddard Geophysical and Astronomical Observatory (GGAO) consists of a radio telescope for VLBI, an SLR site to include MOBLAS-7, SLR-2000 (development system), a 48" telescope for developmental two color Satellite Ranging, a GPS timing and development lab, meteorological sensors, and an H-maser. In addition, we are a fiducial IGS site with several IGS/IGSX receivers.

GGAO is located on the east coast of the United States in Maryland. It is about 15 miles NNE of Washington, D.C. in Greenbelt, Maryland (Table 1).

Table 1. Location and addresses of GGAO at Goddard.

Longitude	76.4935° W
Latitude	39.0118° N
MV3 Code 299.0 Goddard Space Flight Center (GSFC) Greenbelt, Maryland 20771	
<a href="http://www.gsfc.nasa.gov">http://www.gsfc.nasa.gov</a>	

## 2. Technical Parameters of the VLBI Antenna at GGAO

The radio telescope for VLBI at GGAO (MV3) was originally built as a mobile or transportable station. It was previously known as Orion and was part of the original CDP. It is now being used as a fixed site, having been moved to Goddard and semi-permanently installed here in the spring of 1991. In the winter of 2002, the antenna was taken off its trailer and permanently installed at GGAO. The design criteria were:

- Transportability on two tractor trailers, utilizing a 5 meter dish size to maximize reception and mobility considerations,
- Setup of the radio telescope within eight hours (although it has been used as a fixed site since the spring of 1991)

The technical parameters of the radio telescope are summarized in Table 2.

Table 2. Technical parameters of the radio telescope of GGAO for geodetic VLBI.

Parameter	GGAO-VLBI
Owner and operating agency	NASA
Year of construction	1982
Diameter of main reflector $d$	5m
Azimuth range	0...540°
Azimuth velocity	3°/s
Azimuth acceleration	1°/s <sup>2</sup>
Elevation range	0...90°
Elevation velocity	3°/s
Elevation acceleration	1°/s <sup>2</sup>
X-band	8.18 – 8.98 GHz
Receiving feed	Cassegrain focus
$T_{sys}$	24 K
Bandwidth	800 MHz, –2 dB
$G/T$	32.1 dB/K
S-band	2.21 – 2.45 GHz
Receiving feed	Primary focus
$T_{sys}$	19 K
Bandwidth	240 MHz, –2 dB
$G/T$	21.2 dB/K
VLBI terminal type	Mark IV
Recording media	Mark 5B
Field System version	9.10.2

### 3. Technical Staff of the VLBI Facility at GGAO

The GGAO VLBI facility gains from the experience of the Research and Development VLBI support staff. GGAO is a NASA R&D and data collection facility, operated under contract by Honeywell Technology Solutions Incorporated (HTSI). Table 3 lists the GGAO station staff that are involved in VLBI operations.

Table 3. Staff working at the MV3 VLBI station at GGAO.

Name	Background	Dedication	Agency
Jay Redmond	Engineering technician	100%	HTSI
Skip Gordon	Engineering technician	20%	HTSI

#### 4. Status of MV3 at GGAO

Having ceased VLBI operations in May of 2007, MV3 continues on a full time basis to be a major component in the program to demonstrate the feasibility of the VLBI2010 broadband delay concept. Working under the guidance of the Haystack Observatory, MV3 has played a critical role in the advancement of the VLBI2010 project.

The Haystack-constructed front end dewar (see Figure 1), containing the broadband Lindgren feed, two low noise amplifiers, and cryogenic refrigerator, has been upgraded to include directional couplers for phase cal injection and high-pass ( $> 3.1$  GHz) filters to reduce the effect of out-of-band RFI. The RF signal path from the antenna to the electronics van consists of two broadband fiber optic links that interface with an Optical Receiver/Splitter/Amplifier (ORCA) for distribution.

The MV3 electronics van is now equipped with a full complement of Haystack-developed VLBI2010 prototype backend equipment, including four Up/Down Converters (UDC), two Digital Back Ends (DBE), and four Mark 5B+ data recorders. This equipment can be controlled remotely via the internet. Additional MV3 modifications include expanded 5 MHz, 1 pulse per second, and Ethernet distribution. The Mark IV recorder was removed in order to accommodate the VLBI2010 equipment.

As a result of both single station tests at MV3 and dual station tests with an identical system at Westford, significant progress has been made in understanding the advantages and limitations of the broadband concept. Several notable results during 2008 include:

- First fringes with broadband systems on both antennas (8.5 - 9 GHz).
- First fringes from 3.4 to 7 GHz.
- Software control of UDCs implemented for easy frequency selection.
- Demonstrating the usefulness of satellite signals for focus and pointing settings.

#### 5. Outlook

GGAO will continue to support VLBI2010, e-VLBI, and other developmental activities during the upcoming year. Tentative plans for 2009 include:

- Characterization of the Lindgren feed.
- Installation and testing of the new phase calibrator for the VLBI2010 system.
- Installation of a new 5 MHz distribution system in the MV3 electronics van.
- Installation of a new Field System computer.
- Continued investigation and characterization of the performance of the 5-meter MV3 antenna.
- Installation of a new 12-meter VLBI2010 antenna.



Figure 1. Close-up of the VLBI2010 wide band prototype dewar at GGAO.

# Hartebeesthoek Radio Astronomy Observatory (HartRAO)

*Ludwig Combrinck, Marisa Nickola*

## Abstract

HartRAO, the only fiducial geodetic site in Africa, participates in VLBI, GNSS, and SLR global networks, among others. This report provides an overview of our geodetic VLBI activities during 2008. On the 3rd of October 2008, a critical failure of the 26-m radio telescope put a halt to VLBI observations.

## 1. Geodetic VLBI at HartRAO

Hartebeesthoek is located 65 kilometers northwest of Johannesburg within the World Heritage Site known as the Cradle of Humankind, just inside the provincial boundary of Gauteng, South Africa. The nearest town, Krugersdorp, is 32 km distant. The telescope is situated in an isolated valley which affords protection from terrestrial interference. HartRAO uses a 26-metre equatorially mounted Cassegrain radio telescope built by Blaw Knox in 1961. The telescope was part of the NASA deep space tracking network until 1975 when the facility was converted to an astronomical observatory. The telescope is co-located with an SLR station (MOBLAS-6) and an IGS GNSS station (HRAO). HartRAO joined the EVN as an associate member during 2001. Geodetic VLBI has been allocated 18% of the available telescope time. The allocation for geodetic VLBI was increased from 58 24-hour experiments in 2007 to 65 in 2008 to include the CONT08 campaign.



Figure 1. Veld fire in our valley two days after the CONT08 came to an end and about a month before the 26-m (in the foreground) lost its bearing. (Credit: M. Gaylard)



Figure 2. The 26-m telescope breaks down. The gap between the bearing housing and static ring confirms suspicion of a south polar bearing collapse.

## 2. Technical Parameters of the VLBI Telescope of HartRAO

The feed horns used for 13 cm and 3.5 cm are dual circularly polarized conical feeds. The RF amplifiers are cryogenically cooled HEMTs. Tables 1 and 2 contain the technical parameters of the HartRAO radio telescope and its receivers. The data acquisition system consists of a Mark IV terminal and a Mark 5A recorder.

Table 1. Antenna parameters.

Parameter	HartRAO-VLBI
Owner and operating agency	HartRAO
Year of construction	1961
Radio telescope mount	Offset equatorial
Receiving feed	Cassegrain
Diameter of main reflector $d$	25.914 $m$
Focal length $f$	10.886 $m$
Focal ratio $f/d$	0.424
Surface error of reflector	0.5 $mm$
Wavelength limit	< 1.3 $cm$
Pointing resolution	0.001°
Pointing repeatability	0.004°
Slew rate on each axis	0.5° $s^{-1}$

Table 2. Receiver parameters with dichroic reflector (DR), used for simultaneous S-X VLBI, off or on.

Parameter	X-band	S-band
$T_{sys}$ (DR off) ( $K$ )	60	44
$T_{sys}$ (DR on) ( $K$ )	70	50
$S_{SEFD}$ (DR off) ( $Jy$ )	684	422
$S_{SEFD}$ (DR on) ( $Jy$ )	1330	1350
Point source sensitivity (DR off) ( $Jy/K$ )	11.4	9.6
Point source sensitivity (DR on) ( $Jy/K$ )	19	27
3 dB beamwidth (°)	0.092	0.332

## 3. Staff Members Involved in VLBI

Table 3 lists the HartRAO station staff who are involved in geodetic VLBI. Jonathan Quick (VLBI friend) provides technical support for the Field System as well as for hardware problems.

Table 3. Staff supporting geodetic VLBI at HartRAO.

Name	Function	Programme
Ludwig Combrinck	Programme Leader	Geodesy
Jonathan Quick	Hardware/Software	Astronomy
Roelf Botha	Operator	Geodesy
Jacques Grobler	Operator	Technical
Lerato Masongwa	Operator	Technical
Marisa Nickola	Logistics/Operations	Geodesy
Pieter Stronkhorst	Operator	Technical

#### 4. Current Status

On the 3rd of October 2008 the 26-m telescope's cries of distress were heard as a series of loud cracking noises. On investigation, it was discovered that a **critical failure** of the south polar bearing had occurred. To assess the damage properly and replace the bearing will entail lifting the 200 tonnes of structure above the drive shaft. This will be a difficult, risky and costly task, but the void left by the 26-m in the worldwide geodetic VLBI network (especially for ICRF southern sky observations) makes it an essential undertaking. Furthermore, from a geodetic perspective the 26-m telescope acts as a reference point for the co-location of the SLR and GNSS stations on site as well as the reference datum for our country's surveying system.

During 2008 HartRAO participated in 55 experiments (table 4). Due to the mechanical failure of the 26-m telescope, telescope time allocated to geodetic VLBI was not utilized to its fullest extent. When operations came to an unexpected halt on the 3rd of October, ten geodetic sessions still appeared on the 26-m telescope's to-do list for 2008. The Deep South experiment, CRDS49, on the 16th of September, in which we were partnered by Hobart, proved to be the 26-m's swan song for 2008.

Table 4. Geodetic VLBI experiments HartRAO participated in during 2008.

Experiment	Number of Sessions
R1	20
C08	15
CRDS	8
CRF	3
OHIG	3
R&D	2
RDV	2
CRFS	1
T2	1
Total	55

HartRAO was one of only two Southern Hemisphere stations that participated in the **CONT08** campaign. A two month media shipment delay by Customs did not augur well for impending



Figure 3. The polar shaft, ready for installation as a 16-ton pre-assembled unit back in 1961.



Figure 4. The new GPS reference station at the Matjiesfontein site.

CONT08 media shipments. Data had to be e-shipped for the month of July, with the Bonn correlator assisting with downloading data from the JHB TENET mirror server, as well as with recording the data to disk pack and with shipping it to other correlators. Customs released the CONT08 media barely a week before the campaign kicked off. The only maintenance that had to be performed during the entire campaign was necessitated by a massive helium leak causing receivers to warm up. But the CONT08 campaign was not kind to a telescope nearing its half-century. Mechanical stress on the 26-m during 15 days of continuous observation took its toll, and the bearing failure occurred a month later.

With the installation of high-speed connectivity at HartRAO came the prospect of not having to ship data on disk any longer. On 5 May 2008, HartRAO participated in its first EVN **e-VLBI** session together with telescopes from Poland, Sweden, Italy, the UK, and Puerto Rico, and on 22 May 2008, HartRAO participated in the first real-time EVN e-VLBI session using telescopes located in Africa (HartRAO), Europe (Effelsberg, Medicina, Onsala, and Westerbork), North America (Arecibo), and South America (TIGO).

## 5. Future Plans

Determining costs for repairing or replacing the 26-m telescope tops the list for 2009.

Planning for the fundamental space geodetic observatory for South Africa, the HartRAO Matjiesfontein Outstation project, continued during 2008, and the first piece of equipment, a GPS reference station, was installed during December 2008 as part of the IGS network. Communication issues need to be resolved in 2009. There is also the prospect of a gravimeter and a DORIS station occupying the site before the end of 2009.

The Space Geodesy Programme is an integrated programme, combining VLBI, SLR, and GNSS, and is active in several collaborative projects with GSFC, JPL, and GFZ (Potsdam) as well as numerous local institutes. Collaboration also includes CNES/GRGS/OCA and the ILRS community in a Lunar Laser Ranger (LLR) project with local support from the University of Pretoria and the National Laser Centre (CSIR), amongst numerous others. General information as well as news and progress on Geodesy and related activities can be found on <http://geodesy.hartrao.ac.za/>.



# Hobart, Mt. Pleasant, Station Report for 2008

*Jim Lovell, John M. Dickey, Brett Reid, Simon Ellingsen*

## Abstract

This is a brief report on the activities carried out at the Mt. Pleasant Radio Astronomy Observatory at Hobart, Tasmania. During 2008, the observatory participated in 59 IVS VLBI 24-hour observing sessions, and significant progress was made on the AuScope VLBI array which will see three new antennas installed across Australia for geodesy.

## 1. Introduction

The Mt. Pleasant Observatory is located about 15 km northeast of Hobart at longitude 147.5 degrees east and latitude 43 degrees south. Hobart is the capital city of Tasmania, the island state of Australia located to the south of the mainland. The station is operated by the School of Mathematics and Physics at the University of Tasmania. The station has a co-located GPS receiver and a site which is used for absolute gravity measurements.

## 2. Brief Description of VLBI Facilities

The antenna is a 26 m prime focus instrument with an X-Y mount. The focus cabin has a feed translator with provision for four different receiver packages, which enables rapid changeover between geodetic and astronomical requirements. Standard receiver packages provide for operations at L-, S-, C-, X-, and K-bands. There is also a dual frequency S/X geodetic receiver. All of these receivers are cryogenically cooled. The antenna has a maximum slew rate of 40 degrees per minute about each axis. The station is equipped with a Mark IV electronics rack and a Mark 5 VLBI recording system. There is another disk based recording system used by other Australian VLBI antennas.

## 3. Staff

Staff at the observatory consisted of academics, Prof. John Dickey (director), Dr. Simon Ellingsen, and Prof. Peter McCulloch, who has had a large input into the receiver design and implementation. Dr. Jim Lovell is Project Manager for the AuScope VLBI project. Dr. Jamie Stevens is a research fellow and has had input into the Linux systems at the observatory. Mr. Brett Reid is the Observatory Manager whose position is funded by the university. In addition we have an electronics technical officer, Mr. Eric Baynes. For operation of the observatory during geodetic observations, we rely heavily on support from astronomy Ph.D. and postgraduate students.

## 4. Geodetic VLBI Observations

Hobart participated in 59 geodetic VLBI experiments during 2008. These were divided between the APSG (2), CRDS (6), CRF (3), CRFS (1), OHIG (6), R1 (25), R4 (11), RDV (2), and T2 (3) programs. All experiments were recorded using Mark 5A.



Figure 1. The Mt. Pleasant 26 m antenna (photo by Jim Lovell).

## 5. Future Plans: AuScope

AuScope is part of the Australian Government's National Collaborative Research Infrastructure Strategy (NCRIS). It encompasses NCRIS Capability 5.13: "Structure and Evolution of the Australian Continent". An important part of this is the acquisition of three new radio telescopes and a data processing facility for geodesy. AuScope aims to provide a fundamental reference frame in Australia to 1 mm accuracy based on the locations of three radio telescopes as established by VLBI observations. Each site will also host a permanent GPS receiver to tie the telescope reference frame to a denser GPS frame (Figure 2). The construction and operation of the array is being managed by the University of Tasmania, with data correlation supported by Curtin University of Technology.

Three 12 m diameter antennas have been ordered from Patriot Antenna Systems, Inc. The first will be installed at Mt. Pleasant, the second at Katherine (Northern Territory), and the third at Yarragadee (Western Australia). Construction of the first antenna is expected to start at Mt. Pleasant in April 2009 and, once commissioned, will replace the 26 m antenna as the University of Tasmania's contribution to IVS. It is hoped that construction of the Katherine and Yarragadee antennas will be completed by the end of 2009. Each site will be equipped with S/X receiver systems, Vremya-ch Hydrogen maser standards, DBBC samplers, and Mark 5B+ recorders.

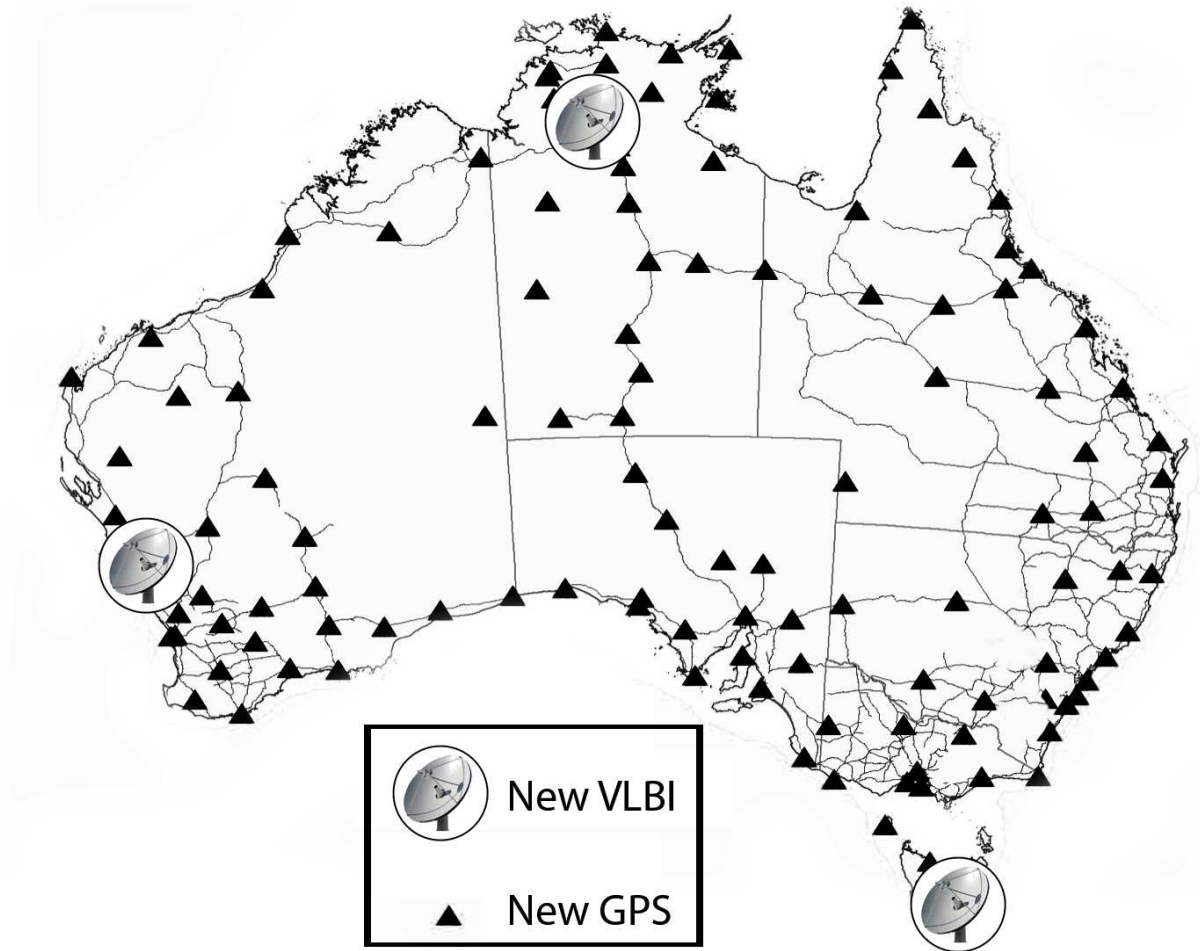

Figure 2. The geographical distribution of VLBI and GPS infrastructure for AuScope. New VLBI stations will be established at Yarragadee (Western Australia), Katherine (Northern Territory), and Hobart (Tasmania) with co-located GPS receivers. An additional  $\sim 100$  GPS receivers will be distributed across the continent.

# Kashima 34-m Radio Telescope

*Eiji Kawai, Mamoru Sekido, Ryuichi Ichikawa*

## Abstract

The Kashima 34-m radio telescope is continuously operated and maintained by the National Institute of Information and Communications Technology (NICT) as a facility of the Kashima Space Research Center (KSRC) in Japan. This brief report summarizes the status of this telescope, the staff and activities during 2008.

## 1. General Information

The Kashima 34-m radio telescope (Figure 1 left) was constructed as a main station of the “Western Pacific VLBI Network Project” in 1988. After that project’s termination, the telescope has been used not only for geodetic purposes but also for astronomy and other purposes. The station is located about 100 km east of Tokyo, Japan and co-located with the 11-m radio telescope and the International GNSS Service station (KSMV) (Figure 1 right). This station is maintained by the Space-Time Measurement Project of the Space-Time Standards Group of KSRC, NICT.



The Kashima 34-m radio telescope.

The layout map of Kashima station.

Figure 1. The Kashima Station.

## 2. Component Description

The Kashima 34-m radio telescope can observe L, C, K, Ka, Q, S, and X bands. The main specifications of the telescope and receivers are summarized in Table 1 and Table 2.

The original frequency coverage of the X-band was from 7860 MHz to 8600 MHz. In order to support IVS observing, we expanded the frequency range of the X-band receiver up to 9080 MHz [2]. For S-band, we have been using the high-temperature superconductor (HTS) band-pass filter

Table 1. Main specifications of the 34-m radio telescope.

Main reflector aperture	34.073 m
Latitude	N 35° 57' 21.78"
Longitude	E 140° 39' 36.32"
Height of AZ/EL intersection above sea level	43.4 m
Height of azimuth rail above sea level	26.6 m
Antenna design	Modified Cassegrain
Mount type	AZ-EL mount
Drive range azimuth	North $\pm 270^\circ$
Drive range elevation	7°-90°
Maximum speed azimuth	0.8°/sec
Maximum speed elevation	0.64°/sec
Maximum operation wind speed	13 m/s
Panel surface accuracy r.m.s.	0.17 mm

Table 2. The receiver specification of the 34-m radio telescope.

Band	frequency (MHz)	Trx (K)	Tsys (K)	Efficiency	SEFD (Jy)	Polarization
L	1350-1750*	18	45	0.68	200	L/R
S	2193-2350	19	72	0.65	340	L/R
C	4600-5100	100	127	0.70	550	L(R)
X-n	8180-9080*	41	48	0.68	210	L/R
X-wL	8180-9080#	41	67	0.68	300	L/R
X-wH	7860-8360#	-	67	0.68	300	L/R
K	22000-24000	105	141	0.5	850	L(R)
Ka	31700-33700	85	150	0.4	1100	R(L)
Q	42300-44900	180	350	0.3	3500	L(R)

\* : 8GHz LNA narrow band use. # : 8GHz LNA wide band use.

★ : Narrow bandwidth filter, 1405 - 1435 MHz, is used generally.

to mitigate the radio frequency interference (RFI) signal due to a third-generation mobile phone system (IMT-2000) [3]. For L-band, we also installed a band-pass filter to mitigate RFI on July 15, 2008. The band-pass frequency is from 1405 to 1435 MHz.

### 3. Staff

The engineering and technical staff of the Kashima 34-m radio telescope are listed in Table 3. Tetsuro Kondo began working in Korea in April 2008, but he continues to support the software correlator of NICT. Yasuhiro Koyama moved to NICT HQ in July 2008, but he continues to support the 34-m antenna. Ryuichi Ichikawa is responsible for the project at Kashima instead of Yasuhiro Koyama.

Table 3. The engineering and technical staff of the Kashima 34-m radio telescope.

Name	Main Responsibilities
Eiji Kawai	responsible for operations and maintenance
Mamoru Sekido	software and reference signals
Kazuhiro Takefuji	mechanical and RF related parts
Ryuichi Ichikawa	responsible for the project
Yasuhiro Koyama	international e-VLBI
Tetsuro Kondo	software correlator development and e-VLBI

#### 4. Current Status and Activities

The 34-m radio telescope contributed to various experiments (such as geodesy, radioastronomy, space navigation, and time transfer). Statistical charts of the telescope operation time according to purpose, including maintenance, is shown in Figure 2. The total operation time during 2008 was 2047 hours, which decreased compared to the previous year’s total of 2319 hours. The main reason for this is that there was annual maintenance and repainting of the backup structure.

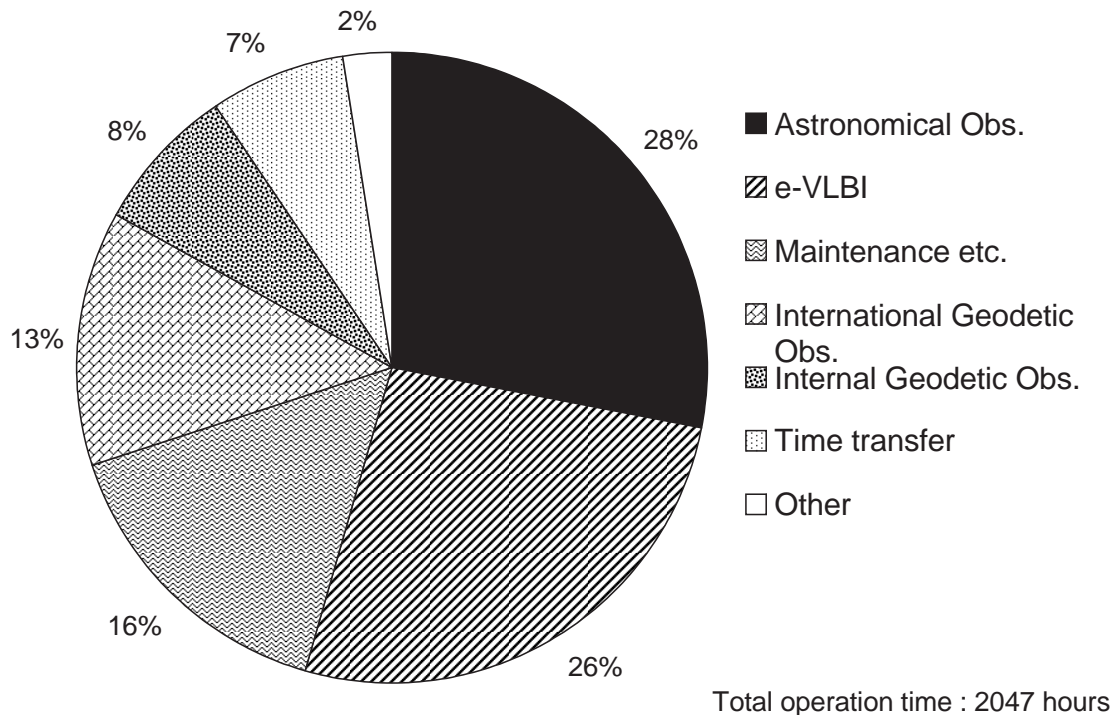

Figure 2. Statistical charts of the telescope operation time according to purpose.

The yearly maintenance was carried out from late August until the end of September. The backup structure of the telescope was repainted from late November through the end of December.

## 5. Future Plans

The Kashima 34-m radio telescope is a main telescope of our project, and already a lot of sessions such as “Experiment for the development of a 1.6 m antenna system”, “Ultra-rapid UT1 experiment with e-VLBI”, and “VLBI experiment for Time Transfer” have been scheduled. Also we are planning repainting to keep up the telescope’s good condition in February and March, and from August through the middle of October.

## References

- [1] Kawai, E., H. Kuboki, Kashima 34-m Radio Telescope, International VLBI Service for Geodesy and Astrometry 2007 Annual Report, NASA/TP-2008-214162, D. Behrend and K. D. Baver (eds.), 51–54, 2007.
- [2] Kawai, E., H. Kuboki, Y. Koyama, T. Kondo, On the expansion of the frequency coverage of an X-band of Kashima 34-m antenna, IVS NICT TDC News, 26, 23-25, 2005.
- [3] Kawai, E., J. Nakajima, H. Takeuchi, H. Kuboki, T. Kondo, M. Suzuki, K. Saito, RFI mitigation at a 2GHz band by using a wide-band high-temperature superconductor filter, J. Geod. Soc. Jpn., Vol. 54, No. 1, pp. 31-37, 2008.

# Kashima and Koganei 11-m VLBI Stations

*Yasuhiro Koyama*

## Abstract

Two 11-m VLBI antennas at Kashima and Koganei used to be stations of the Key Stone Project VLBI Network. The network consisted of four VLBI stations at Kashima, Koganei, Miura, and Tateyama. Since the Miura and Tateyama stations have been transported to Tomakomai and Gifu, the Kashima and Koganei 11-m stations remain as IVS Network Stations. After the regular VLBI sessions with the Key Stone Project VLBI Network terminated in 2001, these stations have been mainly used for the purposes of technical developments and miscellaneous observations. In 2008, a series of geodetic VLBI experiments were performed between the Kashima and Koganei 11-m VLBI stations to evaluate the capability of the VLBI technique for precise time transfer between Time and Frequency laboratories to construct Coordinated Universal Time. Other series of experiments were also carried out for the development of e-VLBI by using the high speed network connection between the sites.

## 1. Introduction

The Key Stone Project (KSP) was a research and development project of the National Institute of Information and Communications Technology (NICT, formerly Communications Research Laboratory) [1]. Four space geodetic sites around Tokyo were established with VLBI, SLR, and GPS observation facilities at each site. The locations of the four sites were chosen to surround Tokyo Metropolitan Area to regularly monitor the unusual deformation in the area (Figure 1).

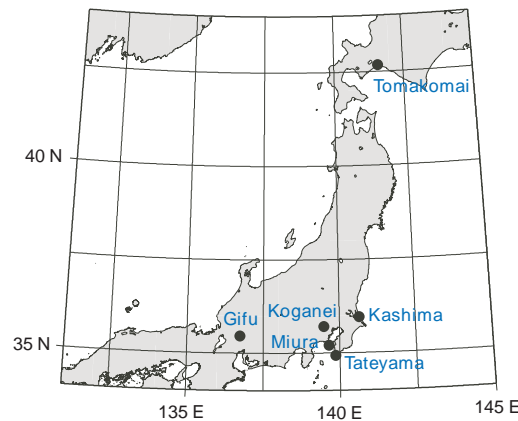

Figure 1. Geographic locations of four KSP VLBI stations and two stations at Tomakomai and Gifu.

Therefore, the primary objective of the KSP VLBI system was to determine precise site positions of the VLBI stations as frequently and quickly as possible. To realize this objective, various new technical advancements were attempted and achieved. By automating the entire process from the observations to the data analysis and by developing a real-time VLBI system using the high speed digital communication links, unattended continuous VLBI operations were made possible. Daily continuous VLBI observations without human operations were actually demonstrated, and



the results of data analysis were made available to the public users immediately after each VLBI session. Improvements in the measurement accuracies were also accomplished by utilizing fast slewing antennas and by developing higher data rate VLBI systems operating at 256 Mbps.

11-m antennas and other VLBI facilities at Miura and Tateyama stations have been transported to Tomakomai Experimental Forest of the Hokkaido University and to the campus of Gifu University, respectively. As a consequence, two 11-m stations at Kashima and Koganei (Figure 2) are remaining as IVS Network Stations. After the regular VLBI sessions with the Key Stone Project VLBI Network terminated in 2001, the 11-m VLBI stations at Kashima and Koganei have mainly been used for the purposes of technical developments and miscellaneous observations.



Figure 2. 11-m VLBI antennas at Kashima (left) and Koganei (right).

## 2. Activities in 2008

Since 2007, we have been performing special purpose geodetic VLBI experiments between the Kashima (11-m or 34-m) and Koganei (11-m) stations to evaluate the capability of geodetic VLBI for precise time and frequency transfer and comparison. Currently, the International Bureau of Weights and Measures (BIPM) is maintaining and evaluating Coordinated Universal Time (UTC) by assembling more than 300 atomic clocks operated at many laboratories around the world. Common view GPS measurements and two-way satellite time and frequency transfer methods are mainly used to compare the signals from time and frequency standard systems located at different laboratories. It is necessary to perform the comparisons over long distances, and the current accuracy of the time comparison measurements is typically a few hundreds of picoseconds by using conventional methods. On the other hand, clock offsets between observing stations are usually estimated from geodetic VLBI experiments, and their uncertainties are typically on the order of a few tens of picoseconds. In the future, it is expected to achieve 4 picoseconds of uncertainties for time delay by using the so-called broadband delay method under development for VLBI2010 by using a wider frequency range than the current S/X configuration. At Koganei, a set of Cesium

Atomic Clocks, Hydrogen Maser Frequency Standard systems, and primary frequency standard systems are operated to contribute to UTC. In addition, optical frequency standard systems are being developed by using ion trap method of Calcium ions and optical lattice clock using Strontium atoms. It is expected to achieve frequency stability (Allan Standard Deviation) in the order of  $10^{-16}$ . If such highly stable optical frequency standard systems are realized, it will become necessary to perform precise time transfer with the other time and frequency laboratories, and we expect to use the geodetic VLBI technique to improve the current time and frequency transfer uncertainties. We are currently developing small wide-band antenna systems with apertures of 1.6 m and 1.5 m in diameter, and we would like to demonstrate the capability of the geodetic VLBI technique for precise time transfer. In 2008, series of VLBI sessions were performed in February, April, August, and December. Each time, S/X-band geodetic VLBI observations were performed continuously from four to 13 days. To compare the results from various time comparison methods, GPS observations were performed at the same time as all the sessions, and Two Way Satellite Time and Frequency Transfer observations were performed in December.

For technical developments, baselines between the Kashima and Koganei stations are also used to perform real-time VLBI observations based on the Internet Protocol (IP). These stations used to be connected by a high speed Asynchronous Transfer Mode (ATM) network in collaboration with the NTT Laboratories until July 2003. From April 2004, NICT started to operate a high speed research test-bed network called JGNII, and both the Kashima and Koganei stations were connected to the JGNII backbone with an OC-192 (10 Gbps) connection. In 2008, the JGNII network was upgraded to JGN2+, and the network between Kashima and Koganei was replaced by 10GbE. Under cooperation with National Astronomical Observatory (NAO), we have installed a 10GbE interface unit at the Kashima 34-m station and the Koganei 11-m station. These interface units are the developments of NAO and are equipped with four VSI-H ports and one 10GbE port. The maximum data rate of the VSI-H ports is 2 Gbps (64 MHz clock rate with 32 parallel data streams). At Kashima 34-m and Koganei 11-m stations, four ADS1000 A/D data samplers are connected to the interface units, and it has become possible to transfer observation data from Koganei to Kashima at the maximum data rate of 8 Gbps (1024 Msps, 2 bits/sample, 4 channels). The transferred data are then correlated at Kashima by a high speed real-time correlator developed by NAO. By using this capability, NICT and NAO performed a series of observations of radio variable stars in S-band and X-band from May until August 2008.

Apart from the VLBI sessions, the Space Environment Group of NICT started to use the 11-m antenna at Koganei to download data from the STEREO spacecraft. Two STEREO spacecraft were launched by NASA in October 2006 to investigate the solar terrestrial environment and to provide 3D images of the Sun and solar storms. The Koganei 11-m antenna is therefore operated every day even if there are no VLBI sessions to perform.

### 3. Staff Members

The 11-m antenna stations at Kashima and Koganei are operated and maintained by the Space-Time Standards Group at Kashima Space Research Center, NICT. The staff members of the group are listed in Table 1. The operation and maintenance of the 11-m VLBI station at Koganei is also greatly supported by Space-Time Standards Group, Space Environment Group and Space Communications Group at Koganei Headquarters of NICT. We are especially thankful to Jun Amagai and Tadahiro Gotoh for their support.

Table 1. Staff members of Space-Time Standards Group, KSRC, NICT

Name	Main Responsibilities
KOYAMA Yasuhiro	Administration
KAWAI Eiji	Antenna Systems
ICHIKAWA Ryuichi	Meteorological Sensors, IGS Receivers
AMAGAI Jun	Antenna System and Timing Systems at Koganei 11m station
SEKIDO Mamoru	Field System, Calibration and Frequency Standard Systems
HASEGAWA Shingo	System Engineer

#### 4. Future Plans

In 2009, we plan to continue precise time transfer VLBI experiments and e-VLBI developments. In addition to the VLBI observations and developments, the data downlink from two STEREO spacecrafts will be continued.

#### References

- [1] Special issue for the Key Stone Project, J. Commun. Res. Lab., Vol. 46, No. 1, March 1999
- [2] Koyama, Y., T. Kondo, H. Osaki, K. Takashima, K. Sorai, H. Takaba, and K. Fujisawa, IVS CRL TDC News, No. 23, Nov. 2003, pp. 26-30
- [3] Koyama, Y., T. Kondo, M. Kimura, and H. Takeuchi, IVS NICT TDC News, No. 26, Sep. 2005, pp. 9-12

# Koike Park Geophysical Observatory

*Kelly Kim*

## Abstract

This report summarizes the technical parameters and the staff of the VLBI system at Koike Park on the island of Kauai.

## 1. KPGO

Koike Park Geophysical Observatory (KPGO) is located in the Koike State Park on the island of Kauai in Hawaii at an elevation of 1,100 meters near the Waimea Canyon, often referred to as the Grand Canyon of the Pacific.



Figure 1. KPGO 20 m and operations building.

Table 1. Location and addresses of Koike Park Geophysical Observatory.

Longitude	159.665° W
Latitude	22.126° N
Koike Park Geophysical Observatory P.O. Box 538 Waimea, Hawaii 96796 USA	

## 2. Technical Parameters of the VLBI System at KPGO

The receiver is of NRAO (Green Bank) design (dual polarization feed using cooled 15 K HEMT amplifiers). The DAR rack and tape drive were supplied through Green Bank. The antenna is of the same design and manufacture as those used at Green Bank and Ny-Ålesund. We presently employ a Mark 5A recorder for all of our data recording.

The technical parameters of the radio telescope are summarized in Table 2.

Timing and frequency is provided by a Sigma Tau Maser with a NASA NR Maser providing backup. Monitoring of the station frequency standard performance is provided by a CNS (GPS) Receiver/Computer system. The Sigma Tau performance is also monitored via the IGS Network.

Table 2. Technical parameters of the radio telescope at KPGO.

Parameter	Kokee Park
owner and operating agency	USNO-NASA
year of construction	1993
radio telescope system	Az-El
receiving feed	primary focus
diameter of main reflector $d$	20m
focal length $f$	8.58m
$f/d$	0.43
surface contour of reflector	0.020inchesrms
azimuth range	0... 540°
azimuth velocity	2°/s
azimuth acceleration	1°/s <sup>2</sup>
elevation range	0... 90°
elevation velocity	2°/s
elevation acceleration	1°/s <sup>2</sup>
X-band (reference $\nu = 8.4GHz$ , $\lambda = 0.0357m$ )	8.1 – 8.9 GHz
$T_{sys}$	40 K
$S_{SEFD}(CASA)$	900 Jy
$G/T$	45.05 dB/K
$\eta$	0.406
S-band (reference $\nu = 2.3GHz$ , $\lambda = 0.1304m$ )	2.2 – 2.4 GHz
$T_{sys}$	40 K
$S_{SEFD}(CASA)$	665 Jy
$G/T$	35.15 dB/K
$\eta$	0.539
VLBI terminal type	VLBA/VLBA4-Mark 5
Field System version	9.7.6

### 3. Staff of the VLBI System at KPGO

The staff at Kokee Park during calendar year 2008 consisted of five people who are employed by Honeywell International under contract to NASA for the operation and maintenance of the observatory. Matt Harms, Chris Coughlin, and Kelly Kim conducted VLBI operations and maintenance. Ben Domingo is responsible for antenna maintenance, with Amorita Apilado providing administrative, logistical, and numerous other support functions.



Figure 2. KPGO Maintenance Day.

### 4. Status of KPGO

Kokee Park has participated in many VLBI experiments since 1984. We started observing with GAPE, continued with NEOS and CORE, and are now in IVS R4 and R1. We also participate in the RDV experiments. We averaged 1.5 experiments per week during calendar year 2000 and increased to an average of 2 experiments of 24 hours each week, with daily Intensive experiments, starting in year 2002 and continuing into 2008.

Kokee Park also hosts other systems, including a 7 m PEACESAT command and receive antenna, a DORIS beacon, and a Turbo-Rogue GPS receiver. Kokee Park is an IGS station.

In October of 2007, Japanese interests, along with representatives from NASA, USNO, and the State Department, held a meeting at KPGO to explore the possible installation of a project called QZSS. In 2008, further investigation continued towards making the QZSS project a part of KPGO. NASA sent an engineering team to investigate the support requirements that would be needed to implement the QZSS project here, and an engineering team from Japan surveyed the site for the hardware that will be installed in 2009. The first of the parts needed for the first phase

of construction arrived recently. Our aging infrastructure will be upgraded in stages as the project moves along.

Also, in 2008, advances were made for making real time VLBI data from KPGO a reality. The agencies that will be responsible for the wideband pipes leading from the site entered into a service agreement late in 2008. We will be testing the data flow of real time data shortly. Initially, the daily Intensive experiments will be targeted so correlation back at the Washington Correlator can happen days earlier than it presently does. 24-hour experiment data flow will hopefully follow in the latter part of 2009.

KPGO was a participant in the CONT08 series of experiments.

## 5. Outlook

Once we start flowing real time data for the daily USNO Intensive experiments in early 2009, we hope to build on that start and support 24-hour experiments in (almost) real time as well. If the sustained data rate requirements cannot be met, we will need to set up a buffering system of some sort with the Mark 5 recorder.

A bit farther down the line are plans to run a fiber cable up the mountainside so the data rate needs can be fully met. The local Navy plans to provide a cable as their budget allows.

Construction plans for the antenna base for the QZSS project are in place and should be started shortly. QZSS has expressed wishes to have a part of their system up and running by mid-2009.

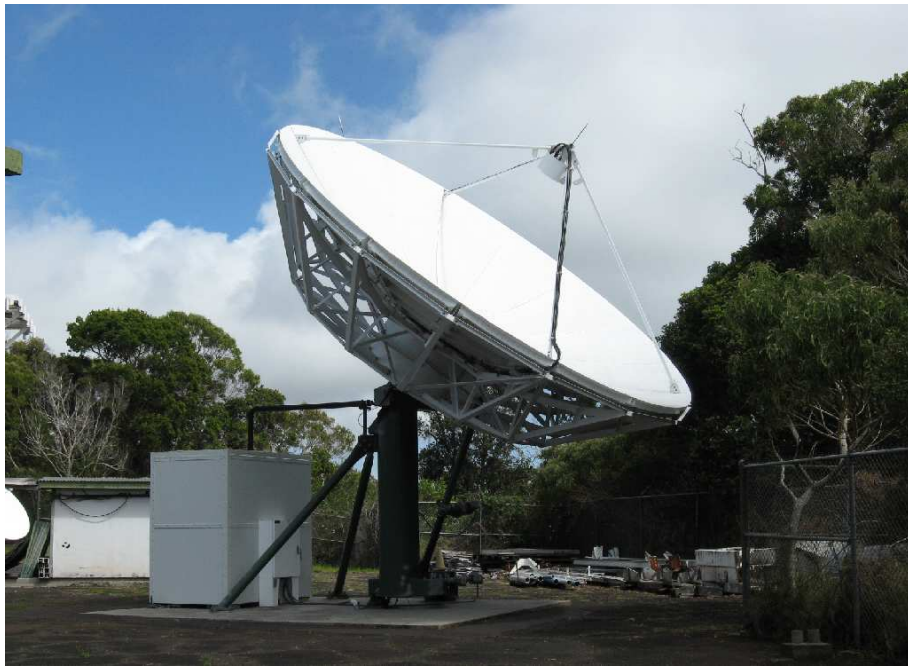

Figure 3. PEACESAT 7 m antenna.

## Matera CGS VLBI Station

*Giuseppe Bianco, Giuseppe Colucci, Francesco Schiavone*

### Abstract

This report describes the status of the Matera VLBI station. Also an overview of the station, some technical characteristics of the system and staff addresses are given.

### 1. General

The Matera VLBI station is located at the Italian Space Agency's 'Centro di Geodesia Spaziale G. Colombo' (CGS) near Matera, a small town in the south of Italy. The CGS came into operation



Figure 1. The Matera "Centro di Geodesia Spaziale" (CGS).

in 1983 when a Satellite Laser Ranging SAO-1 System was installed at CGS. Fully integrated into the worldwide network, SAO-1 was in continuous operation from 1983 up to 2000, providing high



precision ranging observations of several satellites. The new Matera Laser Ranging Observatory (MLRO), one of the most advanced Satellite and Lunar Laser Ranging facilities in the world, was installed in 2002 and replaced the old SLR system. CGS also hosted mobile SLR systems MTLRS (Holland/Germany) and TLRS-1 (NASA).

In May 1990 the CGS extended its capabilities to Very Long Baseline Interferometry (VLBI), installing a 20-m radiotelescope. Since then, Matera has performed in 813 sessions up through December 2008.

In 1991 we started GPS activities, participating in the GIG 91 experiment and installing at Matera a permanent GPS Rogue receiver. In 1994 six TurboRogue SNR 8100 receivers were purchased in order to create the Italian Space Agency GPS fiducial network (IGFN). At the moment 12 stations are part of the IGFN, and all data from these stations, together with 24 other stations in Italy, are archived and made available by the CGS WWW server GeoDAF (<http://geodaf.mt.asi.it>).

In 2000 we started activities with an Absolute Gravimeter (FG5-Micro-G Solutions). The gravimeter operates routinely at CGS, and it is available for external campaigns on request.

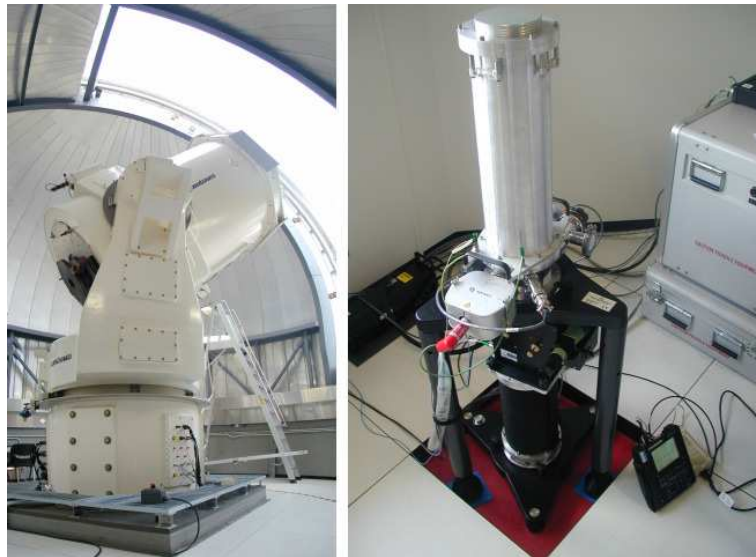

Figure 2. MLRO Telescope and Absolute Gravimeter.

Thanks to the co-location of all precise positioning space based techniques (VLBI, SLR, LLR and GPS) and the Absolute Gravimeter, CGS is one of the few “fundamental” stations in the world. With the objective of exploiting the maximum integration in the field of Earth observations, in the late 1980s ASI extended CGS’ involvement also to remote sensing activities for present and future missions (ERS-1, ERS-2, X-SAR/SIR-C, SRTM, ENVISAT, and COSMO-SkyMed).

## 2. Technical/Scientific Overview

The Matera VLBI antenna is a 20-meter dish with a Cassegrain configuration and an AZ-EL mount. The AZ axis has  $\pm 270$  degrees of available motion. The slewing velocity is 2 deg/sec for both the AZ and the EL axes.

The technical parameters of the Matera VLBI antenna are summarized in Table 1.

The Matera time and frequency system consists of three frequency sources (two Cesium beam and one H-maser standard) and three independent clock chains. The EFOS-8 H-maser from Oscilloquartz is used as a frequency source for VLBI.

In November 2008, the old SWT Pentium control computer was replaced by a new Dell PowerEdge 2950 machine running FSL7 and FS 9.10.4.

Table 1. Matera VLBI Antenna Technical Specifications.

Input frequencies	S/X	2210–2450 MHz / 8180–8980 MHz
Noise temperature at dewar flange	S/X	<20 K
IF output frequencies	S/X	190–430 MHz / 100–900 MHz
IF Output Power (300 K at inp. flange)	S/X	0.0 dBm to +8.0 dBm
Gain compression	S/X	<1 dB at +8 dBm output level
Image rejection	S/X	>45 dB within the IF passband
Inter modulation products	S/X	At least 30 dB below each of 2 carriers at an IF output level of 0 dBm per carrier
$T_{sys}$	S/X	55/65 K
SEFD	S/X	800/900 Jy

### 3. Staff

The list of the VLBI staff members of the Matera VLBI station is provided in Table 2.

Table 2. Matera VLBI staff members.

Name	Agency	Activity	E-Mail
Dr. Giuseppe Bianco	ASI	VLBI Manager	giuseppe.bianco@asi.it
Francesco Schiavone	Telespazio	Operations Manager	francesco.schiavone@telespazio.com
Giuseppe Colucci	Telespazio	VLBI contact	giuseppe.colucci@telespazio.com

### 4. Status

In 2008, 52 sessions were acquired. All sessions were acquired using Mark 5A only. Fig. 3 shows the total Acquisitions Summary per year, starting in 1990.

In 2004, in order to fix all the rail problems, a complete rail replacement was planned. In 2005, due to financial difficulties, it was instead decided that only the concrete pedestal under the existing rail would be repaired. From then on, no rail movements have been noted [1]-[3].

In April 2008, due to cracks on the surface, the AZI-1 wheel was replaced by a newly built one.

In 2008 the process of buying a Mark 5B+ recorder was started, but it hung up because of a lack of CE Marking necessary to import this equipment in Europe.

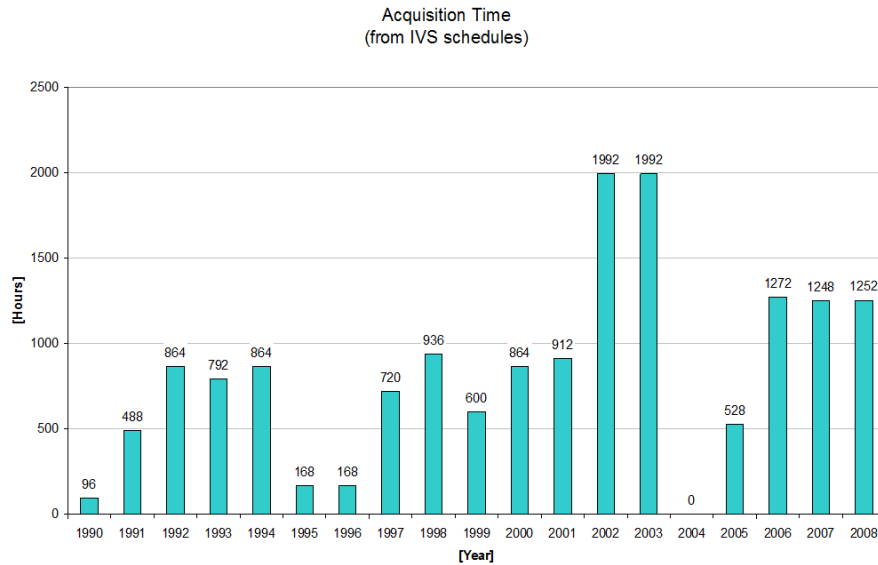

Figure 3. Acquisitions per year.

## 5. Outlook

A second AZI wheel that shows some small cracks needs to be replaced. The plan is to do this job in the first months of 2009.

Negotiation with the builder is in progress in order to get CE Marking on Mark 5B+ and to complete the equipment purchase.

Another goal is to replace the Antenna Control Unit and both Azimuth and Elevation encoders, because it is not possible to find spare parts for these components anymore.

## References

- [1] M. Mannarella “Relazione sulle misure effettuate sulla rotaia dell’antenna VLBI”, Telespazio doc. OT-SPA-SM\_REL\_180010\_1140\_0222, 21/01/2004.
- [2] M. Mannarella “Misure sugli spostamenti indotti sulle piastre e sulla rotaia dell’antenna VLBI”, Telespazio doc. OT-SPA-SM\_REL\_180010\_1320\_0661, 06/04/2005.
- [3] M. Mannarella “Relazione sull’esito dei lavori di ripristino delle parti ammalorate della fondazione dell’antenna VLBI”, Telespazio Doc. OT-SPA-SM\_REL\_180010\_1320\_0732, 27/06/2005.

# The Medicina Station Status Report

*Alessandro Orfei, Andrea Orlati, Giuseppe Maccaferri, Franco Mantovani*

## Abstract

General information about the Medicina Radio Astronomy Station, the 32 m antenna status, and the staff in charge of VLBI observations are provided. In 2008 the data from geodetic VLBI observations were acquired using the Mark 5A recording system with good results. Updates of the hardware have been performed and are briefly described.

## 1. The Medicina 32 m Antenna. General Information

The Medicina 32 m antenna is located at the Medicina Radio Astronomy Station. The Station is run by the Istituto di Radioastronomia and is located about 33 km east of Bologna. The Consiglio Nazionale delle Ricerche was the funding agency of the Istituto di Radioastronomia till the end of 2004. Since January 1, 2005 the funding agency has been the Istituto Nazionale di Astrofisica (INAF).

The antenna, inaugurated in 1983, has regularly taken part in IVS observations since 1985 and is an element of the European VLBI network. A permanent GPS station, which is part of the IGS network, is installed in the vicinity. Another GPS system is installed near the VLBI telescope (MSEL) and is part of the EUREF network.

## 2. Antenna Description

The Medicina antenna has Cassegrain optics, consisting of a primary mirror of 32 m in diameter, and a secondary mirror, called the subreflector, of convex shape and about 3 m in diameter. The subreflector, mounted on a quadrupode, is placed opposite the primary mirror and focuses the radio waves at its center, where the receiver system is located. For some observing frequencies, a simplified optical system is enough. The subreflector is therefore shifted from its normal position, and the receiving system is placed at the primary focus. This is the case for the S-X observations. The antenna can operate in the range between 327 MHz and 22 GHz.

The receivers are cooled with cryogenic techniques to improve the system sensitivity. The antenna's operative receiver is easily changed; only a few minutes are needed to change the observing frequency. A recent picture of the antenna is shown in Figure 1.

## 3. The Staff

Many scientists and technicians take care of the observations. However, a limited number are dedicated to maintaining and improving the reliability of the antenna during the observations: Alessandro Orfei is the Chief Engineer, expert in microwave receivers; Giuseppe Maccaferri is the Technician in charge of the telescope's backend; and Andrea Orlati is the Software Engineer who takes care of the observing schedules and regularly implements SKED, DRUDG and the Field System.



Figure 1. View of the Medicina 32 m dish taken during geodetic VLBI observations. Note that the subreflector is shifted to allow the use of the S/X receiver located in the primary focus of the radio telescope.

#### 4. Current Status and Activities

During 2008 a Mark 5B+ was bought but not connected to the formatter. Some preliminary tests (TVG recording) were done.

At present, 33 TB of disk space is available for geodetic observations.

The 9.9.0 version of the Field System is now running. We plan to upgrade our control PC to the Field System Linux 7 in the near future.

As for receivers, the multifeed system was mounted on the 32m in March 2008. Since then optics alignment has been done, and a pointing model is available. This receiver is intended for SRT, but it will be used on the Medicina antenna until the new telescope will be ready. First testing shows that the central horn, which will be used for VLBI, shows a  $T_{\text{sys}}$  of about 75K at 45 degrees of elevation with a  $\tau$  equal to 0.1. The antenna gain is about 0.1K/Jy. The feed system was designed to have the best performance in terms of crosspolarization in the VLBI band. VLBI observations were made, and fringes were detected. The multifeed, 14 outputs each 2 GHz wide, is now equipped with a total power back-end able to detect 28 GHz bandwidth with sampling rate down to 1 msec.

##### 4.1. Optic Fiber Link

Medicina routinely performs e-VLBI observations at about 1 Gbps.

#### 5. Geodetic VLBI Observations

In 2008 Medicina took part in 23 (24 hour) routine geodetic sessions (namely 4 IVS-T2, 14 IVS-R4, 2 EUROPE, and 3 R&D experiments) plus a special session (CONT08) in August lasting 15 days.

## VERA Geodetic Activities

*Takaaki Jike, Seiji Manabe, Yoshiaki Tamura, Makoto Shizugami, VERA group*

### Abstract

This report describes the status of the VERA network in the context of geodetic VLBI. The main contents are information about its technical parameters and a summary of its geodetic VLBI activities during 2008.

### 1. General Description

VERA is a Japanese domestic VLBI network operated by Mizusawa VERA Observatory, NAOJ. The network consists of four stations which are Mizusawa, Iriki, Ogasawara, and Ishigakijima. Each station is equipped with a 20m radio telescope and a VLBI data acquisition system. The observing frequency bands of VERA are S and X, K (22 GHz), and Q (43 GHz). The Ogasawara antenna is shown in Figure 1. The VERA array is controlled from the Array Operation Center at Mizusawa via the Internet.

VERA determines the positions of Galactic maser sources relative to extragalactic radio sources by phase reference VLBI observation. The goal for the accuracy of the annual parallaxes and proper motions determined from time series analyses of the maser sources' positions is the 10 microarc-second level. Regular astrometric observations have continued since 2003. The annual parallaxes of some radio sources are presently estimated with a precision on the order of 10 microarcseconds (recent result from VERA, PASJ Vol. 60, No. 5, 2008).

Geodetic observations with VERA started in late 2002 and have been done routinely since late 2004. Monitoring of the positions and the movements of the VERA antennas by geodetic observations contributes to maintaining the accuracy of VERA astrometric measurements. Geodetic observations are made in the S-, X-, and K-bands.

General information about the VERA stations is summarized in Table 1, and the geographic locations are shown in Figure 2. The lengths of the baselines range from 1000 km to 2272 km.

VERA contributes to lunar exploration. VLBI observations to determine the orbit of the "KAGUYA" satellite began in the winter of 2007 and continue now. The total number of observing days is about seven every month. The S/X receiving and transmission system is shared between geodetic and KAGUYA observations.

Table 1. General information

Sponsoring agency	Mizusawa VERA Observatory, National Astronomical Observatory of Japan	
Contributing type	Network observing station	
Location	Mizusawa	141° 07' 57".2E, 39° 08' 00".7N, 75.7m (a.s.l.)
	Iriki	130° 26' 23".6E, 31° 44' 52".4N, 541.6m (a.s.l.)
	Ogasawara	142° 12' 59".8E, 27° 05' 30".5N, 223.0m (a.s.l.)
	Ishigakijima	124° 10' 15".6E, 24° 24' 43".8N, 38.5m (a.s.l.)



Figure 1. The VERA Ogasawara antenna which is located in Chichijima Island.

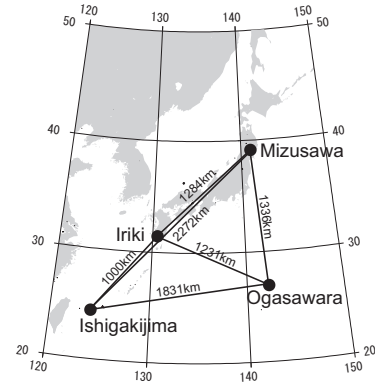

Figure 2. Locations of VERA stations.

Table 2. Antenna parameters

Diameter	20m		
Mount	Azimuth–Elevation		
Surface accuracy	0.2mm (rms)		
Pointing accuracy	<12" (rms)		
	S	X	K
HPBW	1550"	400"	150"
Aperture efficiency	0.25	0.4	0.47
Slew	Azimuth		Elevation
range	-90°–450°		5°–85°
speed	2°.1/sec		2°.1/sec
acceleration	2°.1/sec <sup>2</sup>		2°.1/sec <sup>2</sup>



Figure 3. DIR2000  
1 Gbps recorder used in VERA.

## 2. Technical Parameters

Parameters of the antennas and the front- and back-end systems are summarized in Tables 2 and 3, respectively. The 1 Gbps recorder named DIR2000 is shown in Figure 3.

## 3. Geodetic VLBI Observing Activities

Two observation modes are used for geodetic observations. One is the VERA internal geodetic observing mode. During 2008, VERA internal geodetic observations were carried out 17 times. K-band was used in all VERA internal geodetic observations. Compared to 2007, the number of observations decreased because some observing was cancelled to perform maintenance on the antennas and recorders.

The other observing mode is Mizusawa's joint observing with the Geographic Survey Institute (GSI) within GSI's domestic observing sessions, JADE. The purpose of the JADE participation is to have VERA's coordinates connected via Mizusawa to the terrestrial reference frame realized by

Table 3. Front-end and back-end parameters

front-end					
Frequency band	Frequency range(GHz)	Receiver temperature	Polarization	Receiver type	Feed
S	2.18–2.36	100K	RHC	HEMT	Helical array
X	8.18–8.60	100K	RHC	HEMT	Helical array
K	21.5–24.5	39±8K	LHC	HEMT(cooled)	Horn
back-end					
Type	channels	BW/channel	Filter	Recorder	Deployed station
VERA	16	16MHz	Digital	DIR2000	4 VERA
K5-VSSP	16	4MHz	VC	HDD	Mizusawa

the IVS. Mizusawa's frequency band is S/X, and its recording rate is 128 Mbps. A K5-VSSP data acquisition terminal is used. Mizusawa took part in JADE seven times during 2008.

Use of the 1 Gbps recording mode continued in 2008 according to the JADE schedule at all VERA stations and at Tsukuba. The raw observation data was sent from the Tsukuba 32 m antenna via G-bit optical fiber network and was recorded with the 1 Gbps recording system at the Mitaka FX Correlation Center. All VERA antennas were connected with the IVS network directly due to this observation mode. This observation mode was used four times during 2008, but only one session could be analyzed because of the instability of the clock in the data transmission system between Tsukuba and Mitaka.

#### 4. Earthquake

At 8:43 on June 14, 2008 (JST), the Iwate Miyagi Nairiku Earthquake (M 7.2) occurred. The epicenter's distance and direction from the VERA Mizusawa station was about 20 km WSW. The type of fault was reverse. The seismic intensity at the Mizusawa station was 5+ on the JMA seismic intensity scale. (The maximum is 7.) The west side of Oshu City suffered great damage. Due to co-seismic and post-seismic crustal movements, the VERA Mizusawa antenna moved downward by about 1 cm and westward by about 9 cm. Co-seismic steps in the coordinates obtained from continuous GPS observations are shown in Figure 4. The Mizusawa GPS station that detected the co-seismic steps is shown in Figure 5.

#### 5. Staff Members

The VERA team of NAOJ consists of nine scientists, seven technicians, and four post-docs. Among them, the members of the geodesy group are S. Manabe (chief, scientist), Y. Tamura (scientist), T. Jike (scientist), and M. Shizugami (software technician).



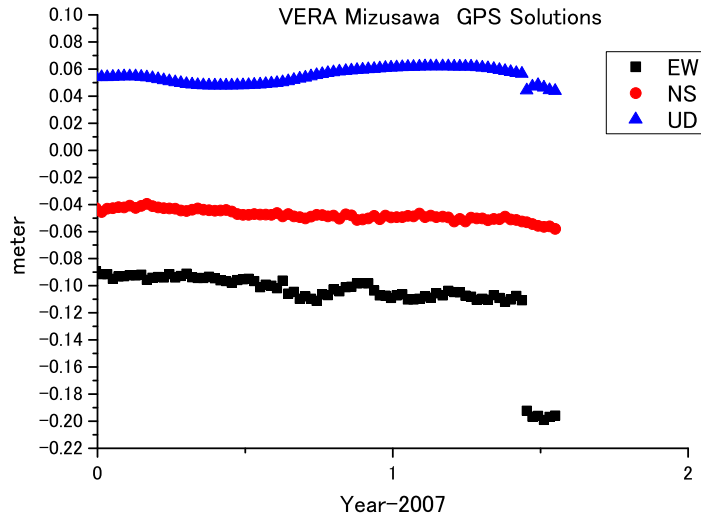

Figure 4. Movement of the Mizusawa GPS station caused by the Iwate Miyagi Nairiku Earthquake.



Figure 5. The Mizusawa GPS station under construction in 2006.

# Noto Station Status Report

*G. Tuccari*

## Abstract

This brief report summarizes the main activities of the Observatory of Noto in 2008.

## 1. Antenna, Receivers and Microwave Technology

At present, the main issue concerning the antenna's functionality is still the azimuth rail, but it is uncertain whether INAF will support the repair expenses.

A new antenna driving software has been realised. It is able to support all the functionalities available with the TIW ACU, and it provides more precise control. The new software also has a Web interface.

The 43 GHz receiver was working with only one polarization, and the replacement of a front-end amplifier was done in the NRAO laboratories. The amplifiers were mounted in September, and EVN observations were successful.

The 86 GHz receiver is still an issue. Functionality measurements in the laboratory showed a pretty high system temperature, so the receiver was moved to MPI in Bonn to be repaired. The front-end mixer was replaced, and a thermal control was added to the local oscillator. A new testing campaign is expected in the first months of 2009.

The SXL receiver (X wide band and double polarization), built some years ago but never adopted in the antenna, will be modified to take into consideration the extra weight that made antenna operations difficult and unsafe. The receiver will be greatly simplified, and the ADC+FILA10G of the DBBC system will be inserted in the primary focus in order to transfer the signals through optical fibres to the control room.

## 2. Acquisition Terminal

A complete DBBC system is under construction for Noto. This process has been accelerated because of the numerous problems encountered with the analog base-band converters. These caused several failures in previous VLBI geo experiments. A Mark 5C/B+ unit is going to be ordered for operation with the DBBC system. Initially both systems will operate in parallel; then after a complete debugging of the new terminal, the old one will be dismissed.

## 3. DBBC Status Report

The hardware and firmware of the new Core2 board is ready and has been tested. Further observational tests are still needed and will start in January 2009. The Core2 uses Virtex 5 LX220 FPGAs but can also be populated with the bigger 330 model. The initially planned DBBCs will have up to 32 MHz BW. DBBCs with larger BW are available for the Core1 and could be adapted to the Core2 modules. The firmware in its present version can provide 4 DBBCs (U+L) on one FPGA, so four Core2 boards are able to produce the functionality of 16 BBCs. The filter shapes have been improved. The tuning precision is increased via a floating point LO. A fixed filter-bank firmware with real output is available, too, but still requires testing. The control software has to

be upgraded from the Core1 to the Core2. Wettzell is working on the integration in the FS. The operating system will soon be converted from Windows XP to Linux, as soon as all the software can be rewritten for that new environment.

The first two DBBC.2 systems have been sent and installed in Wettzell in November. A third system in Wettzell will be upgraded from version 1 to version 2. Additional DBBC.2 prototype backends are ready to be tested and delivered to Effelsberg, Yebes, and New Zealand. Two more systems already delivered to Arcetri and Irbene need to be upgraded to version 2 to be compliant with the standard observing requirements, as they have only a few Core1 boards.

The hardware side of FILA10G, the interface between the DBBC (or any VSI device) and 10 G network, has been completed. A team composed of IRA/MPI/SHAO personnel is jointly developing the firmware. The board will be an interface for the Mark 5C or a direct connection to the network at 1-2-4-10-20 Gbps. It can be used as a standalone element between VSI and the network. The VDIF protocol will be adopted as the data format.



Figure 1. DBBC internal view

The backend will be produced by a spin-off company named HAT-Lab which will start operation probably in the end of January, as numerous bureaucratic procedures have been necessary that took much longer than expected.

A new building in Noto has been completed. New laboratories are available, and so a part of the building will host the spin-off company in charge of the construction of the DBBC systems.

#### 4. Geodetic Observations in 2008

During 2008, the Noto station participated in 12 geodetic experiments: CRF49, EURO91, T2053, T2054, CRF51, EURO92, EURO93, EURO94, T2056, CRF53, EURO95, and EURO96.

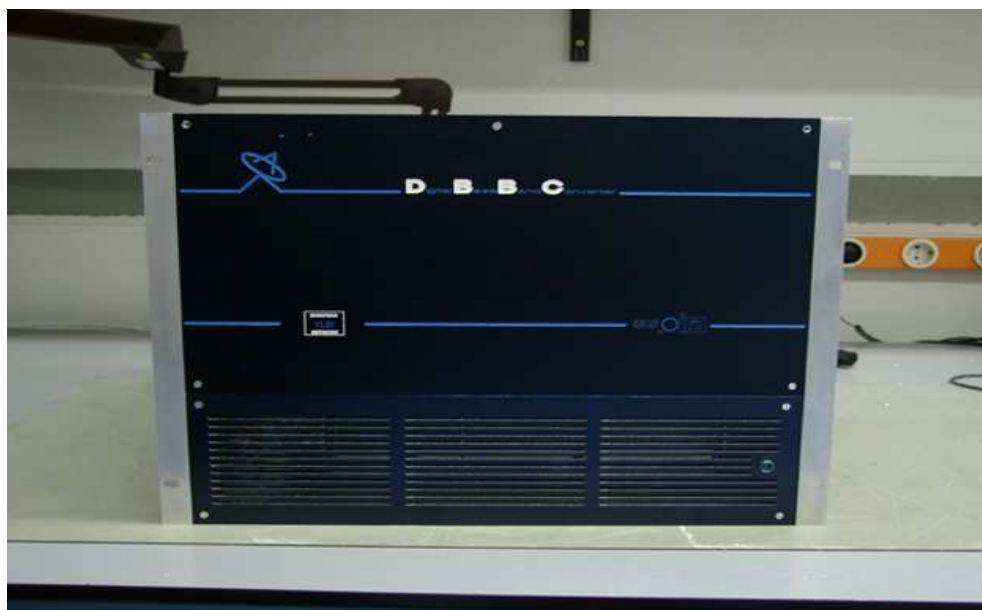

Figure 2. DBBC front view



Figure 3. DBBC rear view

# Ny-Ålesund 20-Meter Antenna

*Ole Bjørn Årdal*

## Abstract

For the year 2008, the 20-meter VLBI antenna at the Geodetic Observatory, Ny-Ålesund, has participated in VLBI experiments, observing 68 of 78 scheduled 24-hour experiments and 36 of 45 scheduled Intensives. Reasons for the lost experiments were the personnel situation and some problems with the dewar/coldhead during spring. Several experiments also had to be run with a warm receiver due to the latter problem. During fall there was a problem with the X-Band cable and the local oscillator that had to be changed. In 2008, Ny-Ålesund was a three-person station until July when Inge Sanden's contract ended and then continued as a two-person station until the CONT08, when Inge Sanden and Svein Rekkedal helped out for some time. After CONT08, until mid-September, the station was only manned by one person followed by a brief period of no observations due to a lack of operators. Ole Bjørn Årdal's contract ended in the end of August, and he agreed on a new one-year contract starting in the end of September. Helge Digre's contract also ended this year. With no renewal, he finished his contract period on 31 October after having worked 11 years for the NMA. In October two new operators were employed and started their training: Carl Petter Nielsen and Geir Mathiassen, both on part-time contracts. Their work schedule is basically three months of work followed by one month off. This caused the station to become a two-person station during December, except for Christmas when only one person manned the station. From July on, except for August, the maintenance and repair were done at a minimum level, given the personnel situation. No responses were made to any alarms, and no errors were corrected during unmanned operation. Ny-Ålesund is a Mark 5A station.

## 1. General Information

The Geodetic Observatory of the NMA is situated at 78.9 N and 11.87 W in Ny-Ålesund, in Kings Bay, at the west side of the island of Spitsbergen. This is the biggest island in the Svalbard archipelago. In 2008, Ny-Ålesund was scheduled for 78 24-hour VLBI experiments, including R1, R4, EURO, RD, T2, and RDV sessions, and 49 Intensives within the INT3 program. Ny-Ålesund also participated in the CONT08 campaign. Four experiments were cancelled by the correlator. Fifteen experiments had to be cancelled because of station problems. Four whole and two half experiments were cancelled because the station was unmanned during the last part of September and half a day during Christmas. Part of the lost observation time was caused by understaffing, and part was due to unpredictable problems. Additional downtime was often caused by bad weather conditions before, during, or after repair, making it impossible to work outdoors.

In addition to the 20-meter VLBI antenna, the Geodetic Observatory has two GPS antennas in the IGS system and a Super Conducting Gravimeter in the Global Geodynamics Project (GGP) installed at the site. There is also a CHAMP GPS and a SATREF (dGPS) installation at the station. At the French research station in Ny-Ålesund, there is a DORIS station. In October 2004 a GISTM (GPS Ionospheric Scintillation and TEC Monitor) receiver was installed at the Statens Kartverk structure in the frame of ISACCO, an Italian research project on ionospheric scintillation observations, led by Giordiana De Franceschi of the Italian Institute of Volcanology and Geophysics (INGV).

## 2. Component Description

The antenna is intended for geodetic use and is designed for receiving in S-band and X-band. Ny-Ålesund is a Mark 5A only station. The station configuration file can be found on the IVS Web site: <ftp://ivscc.gsfc.nasa.gov/pub/config/ns/nyales.config>. Ny-Ålesund is located so far north that the sun is below the horizon from the 23rd of December until the 22nd of February and has midnight sun from 20 April to 27 August. During the polar night there may be daytime aurora. The location of the antenna enables signal reception over the North Pole. In 1998, Ny-Ålesund was the only antenna that could receive signals from the Mars Global Surveyor for 24 hours.

## 3. Staff

Table 1. Staff related to VLBI operations at Ny-Ålesund.

Hønefoss:	Section manager:	Line Langkaas
	Station responsible at Hønefoss:	Svein Rekkedal
Ny-Ålesund:	Station commander:	Helge Digre / Ole Bjørn Årdal
	Engineer	Inge Sanden until 2008.07.31
	Engineer	Ole Bjørn Årdal
	Engineer	Carl Petter Nielsen since 2008.10.01
	Engineer	Geir Mathiassen since 2008.10.06

Inge Sanden's contract ended 2008.07.31, and he did not renew the contract. Inge Sanden and Svein Rekkedal helped us out for a period during CONT08. Ole Bjørn Årdal's contract ended 2008.08.31, and he agreed on a new one-year contract starting 2008.09.30. Helge Digre's contract ended 2008.10.31, and he did not sign the new contract that he was offered. He terminated his contract period. He worked 11 years for the NMA. Ole Bjørn Årdal has since then acted as station commander. In October two new operators were employed and started their training. Carl Petter Nielsen and Geir Mathiassen both have a 3-year part-time contract. They will work three months followed by one month of leave. Svein Rekkedal was granted leave of absence from 2008.12.31 until 2010.12.31.

## 4. Current Status and Activities

Ny-Ålesund participated in the scheduled VLBI experiments, periodically as a tag-along station. Two new FS computers were bought this year and will hopefully be operational by early 2009. During 2008 e-VLBI was used for transferring R1 and INT3 measurements from Ny-Ålesund to the Bonn correlator.

The Super Conducting Gravimeter (SCG) placed on the same foundation as IGS-GPS NYA1 has been running without problems. The yearly service on the system was performed by Dr. Yoshiaki Tamura and Ove Omang in the end of September. National Astronomical Observatory of Japan, Mizusawa VERA Observatory, which owns the SCG, lent this equipment to NMA starting



Figure 1. Ny-Ålesund antenna.

2007.04.01, to continue the scientific measurement series.

A consultant checked the safety aspect of work in the antenna. New safe climbing equipment was bought, and new safety precautions were made. The outer roof of the observatory was renovated due to moisture.

## 5. Future Plans

Ny-Ålesund will continue to participate in the 78 regular and 45 Intensive experiments for which the antenna is scheduled, and it intends to move from tag-along status to fully operational as soon as the observatory is fully manned. The vacant station commander position has been announced and will hopefully be filled by early 2009. We also hope that the new Field System computers will be up and running soon. The SCG has to be refilled with liquid helium each year, and the lift has to be re-certified every year. The insulation in the roof of the Observatory has absorbed a lot of moisture, so the ceiling has to be renovated. This will hopefully happen either during the summer of 2009 or 2010. Because of the moisture in the ceiling, the indoor working environment will be checked by a consultant in early 2009.

# German Antarctic Receiving Station (GARS) O'Higgins

*Christian Plötz, Reiner Wojdziak, Richard Kilger, Alexander Neidhardt*

## Abstract

In 2008 the German Antarctic Receiving Station (GARS) in O'Higgins contributed to the IVS observing program with 10 observation sessions. The timing system was enhanced with a rubidium clock, and the cesium clock was reinstated after repair. First VLBI sessions were completely remote-controlled by starting, attending, and finishing them from Wettzell observatory using a remote extension developed for the Field System at Wettzell.

## 1. General Information

The German Antarctic Receiving Station (GARS) is jointly operated by the Federal Office of Cartography and Geodesy (BKG) and the German Aerospace Center (DLR). The Institute for Antarctic Research Chile (INACH) coordinated the activities and the logistics that need to be done in advance. The 9-m radiotelescope at O'Higgins is used for geodetic VLBI and for downloading remote-sensing images from satellites such as ERS-2 and TerraSAR-X. The access to the station is organized campaign-wise during the Antarctic spring and summer. In 2008 the station was occupied from January to March and from September to December. DLR and BKG jointly sent engineers and operators for the campaigns together with a team which maintained the infrastructure at the station, such as the generation of power.

Over the last years, special flights with "Hercules" aircraft and small "Twin Otter" aircraft were organized by INACH in close collaboration with the Chilean Army, Navy, and Air Force and with the Brazilian Air Force in order to transport the staff, the technical material, and also the food for the entire campaign from Punta Arenas via station Frei on King George Island to the station O'Higgins on the Antarctic Peninsula. Only a few times, the staff and material were transported by ship to O'Higgins. However, due to the fact that the conditions for landing on the glacier became unpredictable, requiring a lot of security precautions, the employment of a ship for transportation to O'Higgins became more and more important. As a consequence of global warming, the glacier is melting. During the summer period, landing with Twin Otter airplanes became impossible. Arrival and departure times were strongly dependent on the weather conditions and on the general logistics. Hence more time to travel from Punta Arenas to the base O'Higgins has to be considered in the future.

After the long Antarctic winter, the equipment at the station usually has to be initialized. Damages, which result from the strong winter period, have to be identified and repaired. Shipment of spare parts or material for upgrades from Germany needs careful advance preparation.

In co-location with the 9-m radiotelescope for VLBI,

- two GPS receivers are operated in the frame of IGS over the whole year. The receivers worked without failure in 2008.
- planning for a new radar tide gauge went ahead. A new mechanical mount system was manufactured and will be installed in February 2009. The radar sensor itself will be position-calibrated by a GPS antenna mounted on top of the radar sensor unit.



- a meteorological station provides pressure, temperature, and humidity and wind information, as long as the extreme conditions outside do not disturb the sensors.
- an H-Maser, an atomic Cs-clock, a GPS time receiver, and a Total Accurate Clock (TAC) are employed for the provision of time and frequency.

The 9-m radiotelescope is designed for two main purposes:

- performing geodetic VLBI and
- receiving the remote sensing data from LEO satellites, mainly from ERS-2 and TerraSAR-X. In 2008, the commissioning phase for the new TerraSAR-X satellite was successfully attended to by GARS O'Higgins



Figure 1. A view of GARS O'Higgins



Figure 2. The 9-m VLBI telescope behind the main operation containers

## 2. Technical Staff

The staff members for operation, maintenance, and upgrade of the GARS VLBI components and the geodetic devices are summarized in Table 1.



Figure 3. A Twin Otter on a supporting flight between O'Higgins and Base Frei

Table 1. Staff – members

Name	Affiliation	Function	Working for
Christian Plötz	BKG	electronic engineer	O'Higgins (responsible), RTW
Reiner Wojdziak	BKG	software engineer	O'Higgins, IVS Data Center Leipzig
Richard Kilger	FESG	software engineer	O'Higgins (for campaign operations)
Alexander Neidhardt	FESG	group leader and VLBI station chief RTW	RTW, SOSW (partly O'Higgins)

### 3. Observations in 2008

GARS participated in the following sessions of the IVS observing program during the Antarctic summer campaign (January-March 2008)

- IVS T2053 05.-06. February 2008
- IVS OHIG55 06.-07. February 2008
- IVS OHIG56 12.-13. February 2008
- IVS OHIG57 13.-14. February 2008

and during the Antarctic spring campaign (October-December 2008)

- IVS OHIG58 05.-06. November 2008
- IVS T2058 11.-12. November 2008
- IVS OHIG59 12.-13. November 2008
- IVS OHIG60 18.-19. November 2008  
(with embedded Jupiter transition observation)
- IVS OHIG61 19.-20. November 2008
- IVS V252I 27.-28. November 2008

The observations were recorded with Mark 5A. The recording media were carried from O'Higgins to Punta Arenas by the staff when they returned home. From Punta Arenas, the disks were shipped by regular air transports to the correlator in Bonn. The V252I TANAMI observation is correlated at Curtin University of Technology, Australia.

#### 4. Maintenance

The extreme conditions in the Antarctic require special attention to the GARS telescope and to the infrastructure. Frequently corrosion results in problems with connectors and capacitors, which need to be detected. The antenna, the S/X-band receiver, the cooling system, and the data acquisition system have to be activated properly. Components that were damaged since the previous campaign usually are replaced. The H-Maser needed to be repaired as the external vacuum ion pump was broken. The satellite communication antenna frequently showed short time interruptions in communication traffic. At the end of November 2008, a complete failure occurred, and the antenna was therefore repaired. Defective components of the LNA were replaced. Also the up-converter had a failure due to an overvoltage of a defective power supply and was temporarily replaced by an external signal generator. The original up-converter then was shipped to Wettzell where it was repaired and tested for the campaigns in 2009.

#### 5. Technical Improvements

The first remote control of complete VLBI sessions was performed successfully in November 2008. The O'Higgins Field System was remotely controlled via an Internet-secure connection from Wettzell. The VLBI session was initiated, attended, and closed from Wettzell's operation room. This is a key feature for extended operation periods at GARS O'Higgins.

The timing system was updated with a new so-called reference generator produced by Timetech which supports a time distribution for 1 PPS, 5 MHz, and NTP via local network.

The local Mark 5A was upgraded with Linux version Debian Etch and the newest stream store software to support SATA drives.

#### 6. Upgrade Plans for 2009

For February 2009, maintenance work on the VLBI cryogenics system is planned. This includes an exchange of the helium compressor and the coldhead unit. The radar tide gauge will be installed directly on shore. Furthermore, a third GPS receiver for backup and reference purposes is going to be installed. Additionally a new communication antenna setup capable of up to 8 Mbit/s is going to extend the bandwidth for Internet connections. The GARS station will be open continuously from the beginning of September 2009 for a planned period of 5 years, because of the Tandem-X (TerraSAR-X add-on for Digital Elevation Measurement) mission. This will significantly extend the operation period for IVS VLBI measurements.

# Onsala Space Observatory – IVS Network Station

*Rüdiger Haas, Gunnar Elgered*

## Abstract

During 2008 the Onsala Space Observatory contributed as an IVS Network Station to 38 VLBI sessions organized by the IVS. Additionally, we performed 27 ultra-rapid dUT1-sessions together with partner telescopes in Japan and Finland. This report briefly summarizes the activities during the year 2008.

## 1. Staff Associated with the IVS Network Station at Onsala

The staff associated with the IVS Network Station at Onsala remained mainly the same as reported in the IVS 2007 Annual Report.

Table 1. Staff associated with the IVS Network Station at Onsala. All e-mail addresses have the ending @chalmers.se, and the complete telephone numbers start with the prefix +46-31-772.

Function	Name	e-mail	telephone
Responsible P.I.	Rüdiger Haas	rudiger.haas	5530
Observatory director	Hans Olofsson	hans.olofsson	5520
Head of department	Gunnar Elgered	gunnar.elgered	5565
Ph.D. students and post-docs involved in GEO-VLBI	Tobias Nilsson	tobias.nilsson	5575
	Tong Ning	tong.ning	5578
Field system responsibles	Michael Lindqvist	michael.lindqvist	5508
	Rüdiger Haas	rudiger.haas	5530
VLBI equipment responsibles	Karl-Åke Johansson	karl-ake.johansson	5571
	Leif Helldner	leif.helldner	5576
VLBI operator	Roger Hammargren	roger.hammargren	5551
Telescope scientists	Lars Lundahl	lars.lundahl	5559
	Lars EB Johansson (–2008.03)	lars.johansson	5564
	Per Bergman (2008.04–)	per.bergman	5552

## 2. Geodetic VLBI Observations for the IVS during 2008

In 2008 the observatory was involved in the five IVS series EUROPE, R1, T2, RDV, and RD08 plus the CONT08 campaign. In total, Onsala participated and acquired useful observations in 38 experiments, see Table 2. All experiments were recorded on Mark 5 modules. Most of the experiments whose data were correlated at the Bonn correlator were additionally recorded in parallel on the PCEVN computer that is daisy-chained to the Mark 5 computer. The observed data of these experiments were then transferred electronically using the Tsunami protocol, and no Mark 5 modules were actually sent to Bonn.

Radio interference due to UMTS mobile telephone signals continued to be a disturbing factor for the S-band observations. Additionally, we suffered from problems with the telescope encoders.

Table 2. Geodetic VLBI experiments at the Onsala Space Observatory during 2008.

Exper.	Date	Remarks	Correlated
R1-311	01.14	module shipment to Washington	o.k.
RD08-01	01.16	module shipment to Haystack	o.k.
R1-312	01.22	module shipment to Bonn, one broken disk	o.k.
R1-315	02.11	E-transfer to Bonn	o.k.
R1-316	02.19	E-transfer to Bonn	o.k.
RD08-02	02.20	some scans lost due to encoder and VLBI rack problems	o.k.
RDV-68	04.02	module shipment to Soccoro	o.k.
EURO-92	04.21	E-transfer to Bonn	o.k.
R1-325	04.22	E-transfer to Bonn	o.k.
R1-327	05.05	module shipment to Washington	o.k.
R1-334	06.23	1 scan lost, E-transfer to Bonn	o.k.
R1-336	07.07	E-transfer to Bonn	o.k.
EURO-94	07.08	E-transfer to Bonn	o.k.
RDV-70	07.09	module shipment to Soccoro	o.k.
C08-01	08.12	encoder problems, module shipment to Washington	o.k.
C08-02	08.13	encoder problems, module shipment to Washington	o.k.
C08-03	08.14	module shipment to Washington	o.k.
C08-04	08.15	encoder problems, 7 scans lost, module shipment to Washington	o.k.
C08-05	08.16	wrong pointing at beginning, module shipment to Washington	o.k.
C08-06	08.17	encoder problems, 17 scans lost, module shipment to Washington	o.k.
C08-07	08.18	encoder problems, some scans lost, module shipment to Washington	o.k.
C08-08	08.19	encoder problems, 3 scans lost, module shipment to Washington	o.k.
C08-09	08.20	module shipment to Washington	o.k.
C08-10	08.21	module shipment to Washington	o.k.
C08-11	08.22	module shipment to Washington	o.k.
C08-12	08.23	module shipment to Washington	o.k.
C08-13	08.24	module shipment to Washington	o.k.
C08-14	08.25	module shipment to Washington	o.k.
C08-15	08.26	module shipment to Washington	o.k.
EURO-95	09.01	E-transfer to Bonn	o.k.
RD08-07	09.10	1 scan lost, o.k., module shipment to Haystack	o.k.
R1-344	09.15	ca. 7 scans lost, E-transfer to Bonn	o.k.
T2-057	09.23	no cable-cal and first hour lost, module shipment to Washington	o.k.
RD08-08	10.07	module shipment to Haystack	o.k.
T2-058	11.11	ca. 2 hours lost due to Mark 5 problems, E-transfer to Bonn	not yet
R1-353	11.17	E-transfer to Bonn	o.k.
R1-354	11.24	E-transfer to Bonn	o.k.
RD08-09	12.02	2 scans missed due to Mark 5 problems, module shipment to Haystack	o.k.

### 3. Fennoscandian-Japanese Ultra-rapid dUT1 Measurements

We continued our involvement in the Fennoscandian-Japanese ultra-rapid dUT1 project, together with our colleagues in Metsähovi, Kashima, and Tsukuba. The aims for 2008 were to

achieve automated telescope operations, real-time data transfer with high data rates, and automated near-real-time correlation and dUT1-analysis. The highlight was the determination of final dUT1-results within 4 minutes after the end of the observing session, see Table 3.

Table 3. Fennoscandian-Japanese ultra-rapid dUT1 experiments involving Onsala in 2008.

Exper.	Date	Stations	Mbps	Transfer	Correlation	Comments/latency
u8052a	02.21	Onsa - Tsuk	256	real-time	real-time	dUT1 within 30 min
u8052b	02.21	Onsa - Tsuk	256	real-time	real-time	dUT1 within 47 min
u8052c	02.21	Onsa - Tsuk	256	real-time	real-time	dUT1 within 7 min
u8052d	02.21	Onsa - Tsuk	256	real-time	real-time	dUT1 within 4 min
u8053a	02.22	Onsa - Kash	256	real-time	failed	transfer problems
u8053b	02.22	Onsa - Kash	256	real-time	partly failed	transfer problems
u8053c	02.22	Onsa - Kash	256	real-time	real-time	dUT1 within 1h 11m
u8053d	02.22	Onsa - Kash	256	real-time	real-time	dUT1 within 18 min
u8053e	02.22	Onsa - Kash	256	real-time	real-time	dUT1 within 21 min
u8053f	02.22	Onsa - Kash	256	real-time	real-time	dUT1 within 1h 6m
u8113a	04.22	Onsa - Kash	256	real-time	real-time	dUT1 within 6h 42m
		Onsa - Tsuk			offline	dUT1 within 11h 32m
u8113b	04.22	Onsa - Kash	512	real-time	real-time	dUT1 within 3h 46m
		Onsa - Tsuk			offline	dUT1 within 10h 2m
u8189a	07.07	Onsa - Kash	128	real-time	failed	wrong setup
u8189b	07.07	Onsa - Kash	128	real-time	failed	wrong setup
u8189c	07.07	Onsa - Kash	128	real-time	failed	wrong setup
u8189d	07.07	Onsa - Kash	128	real-time	failed	wrong setup
u8189e	07.07	Onsa - Kash	128	real-time	real-time	dUT1 within 30 min
u8189f	07.07	Onsa - Kash	128	real-time	real-time	dUT1 within 1h 46m
u8193a	07.11	Onsa - Kash	128	real-time	real-time	dUT1 within 25 min
u8193b	07.11	Onsa - Kash	256	real-time	failed	telescope problems
u8193c	07.11	Onsa - Kash	512	real-time	failed	telescope problems
u8193d	07.11	Onsa - Kash	128	real-time	failed	telescope problems
u8193e	07.11	Onsa - Kash	256	real-time	real-time	dUT1 within 44 min
u8193f	07.11	Onsa - Kash	512	real-time	real-time	dUT1 within 1h 42m
u8245a	09.01	Onsa - Tsuk	512	real-time	offline	dUT1 offline
u8245b	09.01	Onsa - Tsuk	256	real-time	offline	dUT1 offline
u8245c	09.01	Onsa - Tsuk	512	real-time	offline	dUT1 offline

#### 4. Monitoring Activities in 2008

We continued the monitoring activities as described in previous annual reports. This included the calibration of the Onsala pressure sensor using a Vaisala barometer borrowed from the Swedish Meteorological and Hydrological Institute (SMHI). The old NASA pressure sensor (Setra Systems) was removed in late December 2007, and the new Vaisala sensor was used in all VLBI experiments in 2008. Figure 1 shows time series of differences between these three sensors, the corresponding amplitude spectra, and the pressure differences versus the pressure values.

We also continued to monitor the vertical height changes of the telescope tower using the invar

rod system at the 20 m telescope. In collaboration with the University of Karlsruhe we additionally performed a reference point determination of the 20 m telescope and local tie measurement between the VLBI and GNSS reference points. For this project we used a laser tracking system, and the results agree at the sub-millimeter level with the results obtained in 2002. However, in 2008, we could derive the complete covariance matrix of the local tie.

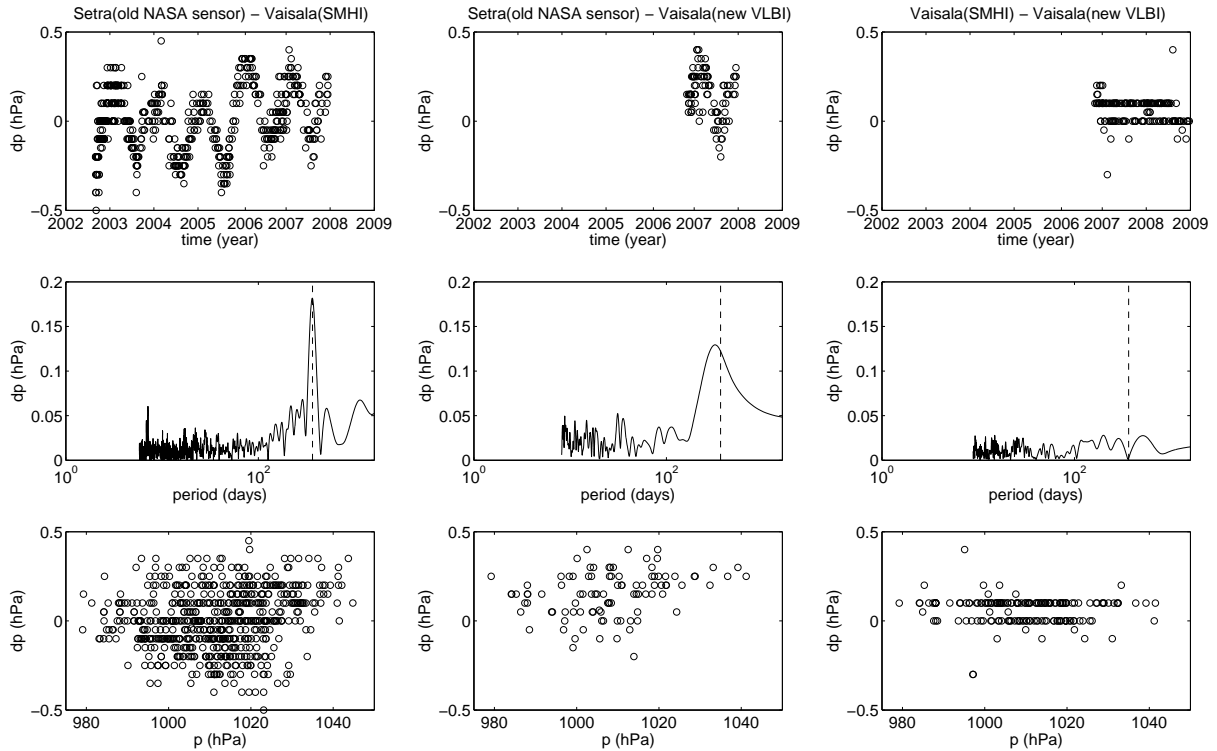

Figure 1. Top row: time series of pressure differences between pairs of pressure sensors. Middle row: corresponding amplitude spectra (the annual period is indicated as vertical line). Bottom row: pressure differences as a function of measured pressure. Left column: pressure differences between Setra (old NASA sensor) and Vaisala (SMHI). Middle column: pressure differences between Setra (old NASA sensor) and Vaisala (new VLBI). Right column: pressure differences between Vaisala (SMHI) and Vaisala (new VLBI).

## 5. Outlook

The Onsala Space Observatory will continue to operate as an IVS Network Station and to participate in the IVS observation series. For the year 2009 a total of 23 experiments in the series EUROPE, R1, T2, and RD09 are planned, and we aim at transferring as many as possible of them electronically to the correlators. We will also continue our activity in the Fennoscandian-Japanese ultra-rapid dUT1-project. Our goal is to achieve and maintain high quality of the observational VLBI data. For this purpose we will continue to monitor the relevant VLBI system parameters in order to detect possible errors as early as possible.

# Sheshan VLBI Station Report for 2008

*Xiaoyu Hong, Qingyuan Fan, Tao An*

## Abstract

This report summarizes the observing activities at the Sheshan station (SESHAN25) in 2008. The Sheshan radio telescope participated in nineteen 24-hour VLBI sessions organized by the IVS and in thirty-seven traditional VLBI experiments, as well as in a number of e-VLBI sessions and formatter tests organized by the EVN. Apart from the international VLBI activities, the telescope was involved in 125 monitoring experiments of the Chinese Chang'E-1 lunar satellite, and in nine observations of the Japanese SELENE lunar satellite. We also report on updates to and development of the facilities at the station.

## 1. General Information

The Sheshan VLBI station (also named SESHAN25 in the geodetic community) is hosted by the Shanghai Astronomical Observatory (SHAO), Chinese Academy of Sciences (CAS). A 25-meter radio telescope is in operation at 1.3, 3.6, 13, 6, and 18 cm wavelengths. The Sheshan VLBI station is a member of the IVS, EVN and APT, and the major observing duties of the telescope include international VLBI experiments for astrometric, geodetic, and astrophysical research. In recent years, the Sheshan radio telescope has been involved in the VLBI tracking of spacecraft, including the Chinese Chang'E-1 and the Japanese SELENE V-star and R-star spacecraft.

## 2. VLBI Observations in 2008

In 2008, the Sheshan radio telescope participated in eighteen 24-hour IVS sessions. A conflict happened between an urgent Chinese Chang'E-1 observation and IVS-T2054; as a result the Sheshan telescope only participated in the first six hours of the IVS-T2054 experiment. The S-band system worked normally throughout the whole year. However some IVS sessions (e.g., R1358 and R1359) were subject to bad pointing at X-band. The bad pointing was also the most likely cause of the failure that happened during the EVN K-band observations in November 2008.

The Chinese Chang'E-1 satellite was launched on October 24, 2007 and entered into its lunar orbit in November 2007. After that the Sheshan radio telescope, along with three other Chinese radio telescopes, conducted intense VLBI tracking of the Chang'E-1 satellite for more than 900 hours in 2008. A five station correlator (Section 4) at Shanghai Astronomical Observatory performed the VLBI data processing.

The Sheshan radio telescope participated for  $\sim 100$  hours in the VLBI observations of V-star and R-star, sub-satellites of the Japanese SELENE lunar satellite.

## 3. Development and Maintenance of Sheshan Telescope in 2008

After the observing problems in the November EVN sessions and the December IVS sessions, we stopped running the antenna, checked the mechanical system, and found that the screws in the elevation encoder were loose. The loose screws were relaxing the elevation encoder and leading to bad pointing, especially at X- and K-bands. From December 3-10, 2008 and again on January 3, 2009, we repaired the elevation encoder, and then we rebuilt the pointing model.





Figure 1. The Sheshan 25m radio telescope.



Figure 2. Fastening the elevation encoder screw in December 2008.

The S/X receivers, the VLBI terminal, the FS, and the H-maser ran normally in 2008. The current FS version at the Sheshan station is 9.10.4. We are developing a remote-monitoring program that is to be installed at the Sheshan station. This program will automate the experiment preparation from fetching the schedule files to creating antenna control files. There are currently two Mark 5A machines at the Sheshan station. The OS system of one machine has been upgraded to Debian 2.6.18.dfsg.1-23etch1, and its Mark 5A software version is 2007y222d02h. The OS system and Mark 5A version of the other machine are RedHat 2.4.20-31.9 and 2007y222d02h, respectively. We are preparing to upgrade the Mark 5A to Mark 5B next year.

The Sheshan radio telescope successfully conducted 512 Mbps e-VLBI tests with Australian and Japanese radio telescopes in June 2008. On June 17, 2008 a trans-continent e-VLBI demo was successfully made at 512 Mbps among Chinese (Sheshan), Australian, and Japanese radio telescopes. Since September 2008 the Sheshan telescope has participated in scientific e-VLBI observations organized by the EVN. On January 15 and 16, 2009, the Sheshan radio telescope participated in the 33-hour continuous 'marathon' e-VLBI session demonstrated live in the opening ceremony of the International Year of Astronomy 2009 in Paris.

#### 4. Development and Maintenance of the Shanghai Correlator in 2008

The Shanghai VLBI correlator system consists of a software correlator and a hardware correlator, which are the central data processing equipment of the VLBI Tracking Chang'E-1 Satellite, Telemetry & Control Subsystem. The five station hardware correlator currently works at 16 Mbps per station in real-time mode and at 256 Mbps per station in post-processing mode. An e-VLBI system consisting of four Chinese radio telescopes (in Shanghai, Urumqi, Beijing, and Kunming) and a software correlator is being developed. A new hardware correlator intended mainly for the geometric project of the Crustal Movement Observation Network of China (CMONC) is also under development.

In December 2008, the Chang'E-1 explorer achieved an orbit transfer, and the orbit altitude was changed from 200 km to 100 km. Benefitting from the upgraded fringe search module, the software correlator successfully fulfilled all the VLBI data correlation in near real-time mode.

In 2009, on the baseline of Shanghai-Urumqi, the first CVN two station high-speed e-VLBI (256 Mbps/station) experiment was processed by a high-speed ten station software correlator prototype running on a computer cluster.

#### 5. Shanghai Observatory Hosts 7th International e-VLBI Workshop

The 7th International e-VLBI Workshop was held in Shanghai, China, on June 16-17, 2008 (<http://www.shao.ac.cn/eVLBI2008>). 87 attendees from 11 countries enjoyed a good time in the workshop. 27 oral presentations and six posters were presented on topics covering the status of e-VLBI, on-going projects in e-VLBI facilities around the world, the latest scientific outcomes using a high data rate, and e-VLBI technology development. Two live demos of e-VLBI experiments were conducted. One demonstrated e-VLBI applications to scientific research, and the other demonstrated space exploration. The international cooperation in e-VLBI science and technology was enthusiastically discussed in the meeting. A working group was set up to draft standards for an e-VLBI data format and transfer protocols.

Table 1. The staff at the Sheshan VLBI Station.

Name	Background	Position & Duty	Contact
Xiaoyu HONG	Astrophysics	Director, Astrophysics	xhong@shao.ac.cn
Qingyuan FAN	Ant. Control	Chief Engineer, Antenna	qyfan@shao.ac.cn
Zhuhe XUE	Software	Professor, FS	zhxue@shao.ac.cn
Quanbao LING	Electronics	Senior Engineer, VLBI terminal	qling@shao.ac.cn
Tao AN	Astrophysics	VLBI friend, Astrophysics	antao@shao.ac.cn
Weihua WANG	Astrophysics	Associated Professor, Astrophysics	whwang@shao.ac.cn
Hong YU	Ant. Control	Associated Professor, Antenna	yuhong@shao.ac.cn
Bin LI	Microwave	Technical friend, receiver	bing@shao.ac.cn
Jinqing WANG	Electronics	Engineer, Antenna	jqwang@shao.ac.cn
Lingling WANG	Software	Engineer, VLBI terminal	llwang@shao.ac.cn
Rongbing ZHAO	Software	Engineer, VLBI terminal	rbzhao@shao.ac.cn
Bo XIA	Electronics	Operator	bxia@shao.ac.cn
Wei GOU	Electronics	Operator	gouwei@shao.ac.cn
Linfeng YU		Operator	lfyu@shao.ac.cn
Yongbin JIANG		Operator	jyb@shao.ac.cn

## 6. The Staff and Personnel Changes of Sheshan VLBI Station

Table 1 lists the group members who operate and maintain the Sheshan radio telescope. Linfeng Yu and Yongbin Jiang joined the group in July 2008.

## 7. Prospects

In 2009 the Sheshan radio telescope will take part in 19 IVS sessions.

A project to build a new 65 m radio telescope was funded in 2008. The new telescope will be built ~4 km west of the current site of the Sheshan 25 m radio telescope. It is planned to be completed in 2012.

# Simeiz VLBI Station - H-maser and Mark 5B+ Upgrade

*A. E. Volvach*

## Abstract

We summarize briefly the status of the 22-m radio telescope as an IVS Network Station. In 2008 RT-22 was equipped with a modern Mark 5B+ VLBI recording system and a new H-maser. That gives the possibility to continue astrophysical and fundamental geodetic VLBI observations.

## 1. General Information

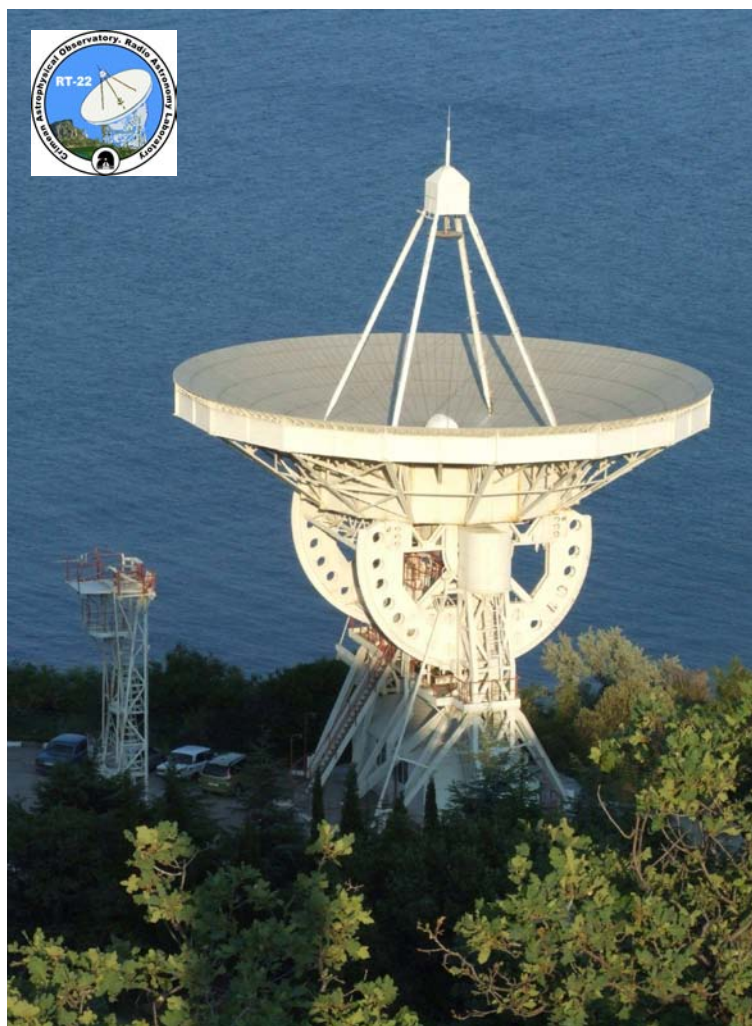

Figure 1. The Simeiz VLBI station.

The Simeiz VLBI Station (also known as CRIMEA in the geodetic community), operated by Radio Astronomy Laboratory of Crimean Astrophysical Observatory of the Ministry of Education

and Sciences of Ukraine, is situated on the coast of the Black Sea near the village Simeiz 20 km west of the city Yalta in Ukraine.

Radio telescope RT-22 has a steerable parabolic mirror with a diameter of 22 m and a focal length of 9,525 mm. The surface has a root mean square accuracy of 0.25 mm and an effective area of 210  $m^2$  which is independent of elevation angle. The antenna is an azimuth-elevation mount with axis offset  $-1.8 \pm 0.2$  mm. The maximal slewing rate is 1.5°/sec. A control system of the telescope provides pointing accuracy of 10".

The foundation of the telescope is 9 meters deep consisting of 3 meters of crushed stones and then 6 meters of concrete. The height of the elevation axis above the foundation is 14.998 meters. The telescope is located at 80 meters from the edge of the Black Sea. Parameters of the 22 meter radio telescope are presented in Table 1.

Table 1. The antenna parameters of the Simeiz station.

Diameter D	22 m
Surface tolerance (root mean square)	0.25 mm
Wavelength limit	2 mm
Feed System	Cassegrain system or primary focus
Focal length F	9.525 m
Focal ratio F/D	0.43
Effective focal length for Cassegrain system	134.5 m
Mounting	Azimuth-Elevation
Pointing accuracy	10 arcsec
Maximum rotation rate	1.5°/sec
Maximum tracking rate	150"/sec
Working range in Azimuth (0 to South)	$-270^\circ \pm 270^\circ$
in Elevation	$0^\circ - 85^\circ$

The control system of the radio telescope provides the possibility to point the antenna and to track the observed source in two regimes: autonomous and automatic. All modes of the radio telescope operation (antenna motion, radiometer readings, and data recording) are given from a special host computer in automatic regime. The 2 GHz and 8 GHz receivers, as well as the phase and amplitude calibration units, have been installed in the primary focus of the antenna.

Table 2 shows the 2 and 8 GHz receivers' parameters.

Table 2. Receiver performance of the Simeiz antenna (temperatures in K).

Band	Frequency	T <sub>sys</sub>	T <sub>receiver</sub>	T <sub>feed</sub>	T <sub>mainlobe</sub>	T <sub>sidelobes</sub>
S	2.1 - 2.5 GHz	100	40	25	7	28
X	8.18 - 8.68 GHz	80	50	5	10	15

## 2. Current Status and Activities

In 2008, RT-22 was equipped with a modern Mark 5B+ VLBI recording system and a new H-maser. This allows the continuation of astrophysical and fundamental geodetic VLBI observations.

The Hydrogen Frequency and Time Standard provides the highest frequency-stable 5 MHz, 100 MHz, and 1 Hz (time scale) output signals with the following characteristics (Table 3).

Table 3. H-maser characteristics.

Frequency accuracy (factory calibration)	$\pm 5 \cdot 10^{-13}$
Frequency corrector: resolution	$1 \cdot 10^{-14}$
range	$1 \cdot 10^{-10}$
Frequency stability (Allan variance at 25° C, environmental effects are excluded):	
1 s	$< 3 \cdot 10^{-13}$
10 s	$< 3 \cdot 10^{-14}$
100 s	$< 8 \cdot 10^{-15}$
1000 s	$< 3 \cdot 10^{-15}$
1 day	$< 3 \cdot 10^{-15}$
Phase noise (dB/Hz) (at the 5 MHz output):	
10 Hz	$< -125$
100 Hz	$< -140$
1000 Hz	$< -150$

The H-maser was put into operation at the 22-m radio telescope, and the first session was carried out on December 16, 2008 (IVS-T2059).

In 2008 the positions of the points in the Simeiz-Katsively geodynamics test area were determined in a special GPS Survey Campaign of the Main Astronomical Observatory. It consisted of two satellite laser ranging stations, a permanent GPS receiver, a sea level gauge, and the radio telescope RT-22. All these components are located within 3 km (Figure 2).

The local geodetic ties between the VLBI, SLR, and GPS reference points of the station Simeiz-Katsively were analysed [1].

A number of relatively small regions of the Earth have been found where the annual periodicity of seismic activity is most prominent; namely the Balkans and Turkey, an isthmus between North and South America, Alaska and the Aleutians, and some others. In both hemispheres, these regions are associated with subduction zones or intensely faulted segments of the continental crust [2].

The annual period of seismic activity of the earth was determined for the time span 1964-2007. The catalog of the National Earthquake Information Center (1928-2007) was used for Fourier analysis of planetary earthquakes in 1964-2007 (403,849 earthquakes with  $M \geq 3.0$  and depth of hypocenter  $H \geq 1\text{km}$ ) separately for the Northern Hemisphere (248,056 events) and for the Southern Hemisphere (152,928 events). The annual periodicity in the occurrence of weak earthquakes ( $M < 5.0$ ) is revealed with high significance level. All of the peculiar properties of this period (dependence on geographic altitude and depth of hypocenters, north-south asymmetry), which were discovered for 1964-1990, remain the same for 1964-2007 [3].

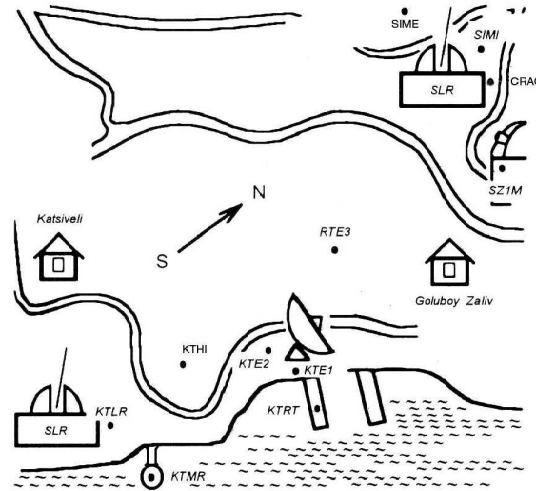

Figure 2. The geodynamics area “Simeiz-Katsiveli”.

An interdepartmental center for the collective use of the radio telescope RT-22 was created on the basis of the Scientific-Research Institute “Crimean Astrophysical Observatory” of the Ministry of Education and Sciences of Ukraine.

During last year Simeiz station regularly participated in various radio astronomy programs including VLBI and single-dish observations of quasars and planets.

Table 4. The current projects.

Very Long Baseline Interferometry	Astrophysics, geodesy, astrometry and radar projects with the international networks.
Monitoring of AGN	The regular monitoring at frequencies 22.2 and 36.8 GHz.
Molecular lines observations at mm wavelength	Observations in molecular lines of maser sources, star forming regions, and other objects have been intensively carried out since 1978 in the range from 1.6 GHz up to 115 GHz.

### 3. Future Plans

Our plans for the coming year are the following: to operationally observe with the Mark 5B+ VLBI recording system and to install a VLBI Data Acquisition System DBBC.

### References

- [1] Bolotina, O.V., et al. // Kinematics and Physics of Celestial Bodies. 2008. V.24. N.5, P.388.
- [2] Volvach A.E., Gorkavyi N.N., Dmytrotso A.I., Levitsky L.S. // Bulletin of CrAO. 2008. V.104, P.145.
- [3] Volvach A.E., Gorkavyi N.N., Dmytrotso A.I., Levitsky L.S. // Bulletin of CrAO. 2009. in press.

# Svetloe Radio Astronomical Observatory

*Sergey Smolentsev, Ismail Rahimov*

## Abstract

This report summarizes information on recent activities at the Svetloe Radio Astronomical Observatory (SvRAO). During the previous year a number of changes were carried out at the observatory to improve some technical parameters and upgrade some units to required status. The report provides also an overview of current geodetic VLBI activities and gives an outlook for the next year.

## 1. Introduction

Svetloe Radio Astronomical Observatory (SvRAO) (Fig. 1) was founded by the Institute of Applied Astronomy (IAA) as the first station of the Russian VLBI network QUASAR [1].



Figure 1. Svetloe observatory.

## 2. Radio Telescope and Registrations

- Electrical part of gear and pointing system of Radio Telescope was upgraded in 2008.
- Mark 5B and RDR-1 (RADIOASTRON) recorders were put into operation (only for domestic sessions in 2008).

The RDR-1 terminals will be used in 2009 for observations within the RADIOASTRON space mission.



Table 1. Technical parameters of the radio telescope.

Year of construction	2000
Mount	AZEL
Azimuth range	$\pm 270^\circ$ (from south)
Elevation range	from $-5^\circ$ to $95^\circ$
Maximum azimuth - velocity - tracking velocity - acceleration	1.5 $^\circ/s$ 1.5 $'/s$ 0.2 $^\circ/s^2$
Maximum elevation - velocity - tracking velocity - acceleration	0.8 $^\circ/s$ 1.0 $'/s$ 0.2 $^\circ/s^2$
Pointing accuracy	better than $10''$
Configuration	Cassegrain (with asymmetrical subreflector)
Main reflector diameter	32 m
Subreflector diameter	4 m
Focal length	11.4 m
Main reflector shape	quasi-paraboloid
Subreflector shape	quasi-hyperboloid
Surface tolerance of main reflector	$\pm 0.5$ mm
Frequency capability	1.4–22 GHz
Axis offset	$+7.5 \pm 0.5$ mm

### 3. Participation in IVS and Domestic Observational Programs

During 2008 Svetloe station participated in 72 24-hour IVS-R4, IVS-R1, IVS-T2, EURO, R&D, and CONT08 sessions and in 25 IVS Intensive sessions (Table 2).

SvRAO fulfilled ten daily observations in the frame of domestic program Ru-E for VLBI-determination of all Earth orientation parameters, and nine 8-hour sessions for obtaining Universal Time.

Test observation sessions were performed in the frame of EVN programs.

Table 2. List of IVS sessions observed at SvRAO in 2008.

Month	IVS-Int	IVS-R4	IVS-R1	IVS-T2	CONT08	R&D	EURO	EVN	EK
January	2	4							
February	2	4		1					
March	2	4	1						
April	2	5		1		1			
May	5	4				1			
June	2	4						1	
July	1	4		1		1			
August	2	2	1		15				2
September	2	4		1					
October	2	5							3
November	1	3					1		
December	2	4							
Total	25	47	2	4	15	3	1	1	5

#### 4. Co-location GPS and Laser Ranging System (LRS)

- The TopCon GPS/GLONASS/GALILEO receiver with meteo station WXT-SIO was tested and put into operation.
- LRS “Sazhen-TM” will be mounted in 2010–2011.

#### 5. Outlook

Our plans for the coming year are the following:

- To participate in IVS-R1, IVS-R4, IVS-T2, IVS-R&D, EUROPE, and IVS-Intensive observational sessions.
- To participate in domestic observational programs for obtaining Earth orientation parameters and Universal Time.
- To continue geodetic control of the antenna parameters.

#### References

- [1] Site <http://www.ipa.nw.ru>.

# JARE Syowa Station 11-m Antenna, Antarctica

*Koichiro Doi, Kazuo Shibuya, Yuichi Aoyama*

## Abstract

The operation of the 11-m S/X-band antenna at Syowa Station (69.0°S, 39.6°E) by the Japanese Antarctic Research Expeditions (JAREs) started in February 1998 and continues until today (January 2009). A cumulative total of 83 quasi-regular geodetic VLBI experiments were observed by the end of 2008. Syowa Station will participate in six OHIG sessions in 2009.

The data from six OHIG sessions in 2008 were recorded on hard disks through the K5 terminal. They will be brought back from Syowa Station to Japan in April 2009. The data from the OHIG51 through the OHIG57 sessions observed by JARE48 and JARE49 have been transferred to the Bonn Correlator directly by way of one of NICT's servers. Analysis results obtained from the data until the OHIG56 session indicate that the length of the Syowa-Hobart baseline is increasing with a rate of  $54.7 \pm 0.4$  mm/yr and that the length of the Syowa-HartRAO baseline is increasing with a rate of  $11.7 \pm 0.3$  mm/yr. The length of the Syowa-O'Higgins baseline is slightly increasing with a rate of  $1.7 \pm 0.9$  mm/yr.

## 1. Overview

Syowa Station has become one of the key observatories in the Southern Hemisphere's geodetic network, as reported in [1]. For VLBI, the Syowa antenna is registered as IERS Domes Number 66006S004, and as CDP Number 7342. The basic configuration of the Syowa VLBI front-end system has not changed from the description in [2].

A K5 recording system was introduced at Syowa Station in September 2004. Syowa's K4 recording terminal was fully replaced by K5 simultaneously with the termination of the SYW session at the end of 2004. Syowa has participated in the OHIG sessions in the austral summer season since 1999. Data transfer through an Intelsat satellite link from Syowa Station to NIPR became possible with the introduction of the K5 system, but huge VLBI data transfers are not realistic because of the low transfer speed.

## 2. Notes on System Maintenance

There is no significant problem in the "mechanical system". The hydrogen maser set (Anritsu RH401A; 1002C) was used for observations from 2004 to 2008. A backup hydrogen maser set (Anritsu RH401A; 1001C) is also operating normally. The tube in the Cs frequency comparator and local oscillator will have to be replaced with a new one in the near future.

## 3. Session Status

Table 1 summarizes the status of processing as of January 2009 for the sessions after 2004. The SYW sessions consisted of Syowa (Sy), Hobart (Ho), and HartRAO (Hh). The OHIG sessions involved Fortaleza (Ft), O'Higgins (Oh) and Kokee Park (Kk), Parkes (Pa) with TIGO Concepción (Tc), together with the three SYW antennas. In 2005, Syowa joined the CRD sessions, but after 2006, Syowa participated only in OHIG sessions. Syowa participated in six OHIG sessions in 2008.

Until 2004, K4 tapes containing the OHIG sessions' data from Syowa Station were copied to Mark IV tapes at GSI, and the Mark IV tapes were sent to the Mark IV Correlator for final

correlation. Since the introduction of the K5 system, K5 hard disk data brought back from Syowa Station have been transferred by ftp to the MIT Haystack Observatory or the Bonn Correlator through a NICT server and converted to the Mark 5 format data there.



Figure 1. Syowa VLBI staff for JARE-49 (February 2008 — January 2009) and JARE-50 (February 2009 — January 2010). From left to right: Hideaki Kumagai, Yuichi Aoyama, Yuji Yamaguchi, and Yusuke Murakami.

#### 4. Staff of the JARE Syowa Station 11-m Antenna

- Kazuo Shibuya, Project coordinator at NIPR.
- Koichiro Doi, Yuichi Aoyama, Liaison officer at NIPR.
- Takanobu Sawagaki (from Hokkaido University), Chief operator for JARE-47 (February 2006 — January 2007).
- Hiroshi Ishii (from NEC), Antenna engineer for JARE-47.
- Naoki Arai (from Electric Navigation Research Institute), Chief operator for JARE-48 (February 2007 — January 2008).
- Sachiko Nagashima (from MontBell Co., Ltd.) Operator for JARE-48.
- Hitoshi Sugawara (from NEC), Antenna engineer for JARE-48.
- Yuichi Aoyama (from National Institute of Polar Research), Chief operator for JARE-49 (February 2008 — January 2009) (second from leftmost in Figure 1).
- Hideaki Kumagai (from NEC), Antenna engineer for JARE-49 (leftmost in Figure 1).

Table 1. Status of SYW and OHIG experiments as of January 2009

Code	Date	Station	Hour	Correlation	Solution	Notes
OHIG29	2004/Feb/10	Ho, Hh, Ft, Oh, Tc	24 h	Yes	Yes	(J45)
SYW030	2004/Apr/07	Ho, Hh	24 h	Yes	Yes	
SYW031	2004/Aug/18	Ho, Hh	24 h	Yes	Yes	
OHIG32	2004/Oct/16	Ho, Hh, Ft, Oh, Kk, Tc	24 h	No	No	
OHIG33	2004/Nov/09	Ho, Ft, Oh, Kk, Tc	24 h	Yes	Yes	
OHIG34	2004/Nov/30	Ho, Hh, Ft, Oh, Kk, Tc	24 h	Yes	Yes	
OHIG35	2004/Dec/08	Ho, Hh, Ft, Oh, Kk, Tc	24 h	Yes	Yes	
SYW032	2004/Dec/13	Ho, Hh	24 h	Yes	Yes	
OHIG36	2005/Jan/26	Ho, Hh, Ft, Oh, Kk	24 h	Yes	Yes	
OHIG37	2005/Feb/02	Ho, Hh, Ft, Oh, Kk	24 h	Yes	Yes	(J46)
OHIG38	2005/Feb/15	Ho, Hh, Ft, Oh, Kk	24 h	Yes	Yes	
CRDS18	2005/Apr/11	Ho, Hh	24 h	Yes	Yes	
CRDS19	2005/May/10	45, Hh	24 h	Yes	Yes	
OHIG39	2005/Nov/08	Ho, Hh, Ft, Oh, Kk	24 h	Yes	Yes	
OHIG40	2005/Nov/09	Ho, Hh, Ft, Oh, Kk	24 h	Yes	Yes	
OHIG41	2005/Nov/16	Ho, Hh, Ft, Oh, Kk	24 h	Yes	Yes	
OHIG42	2006/Jan/31	Ho, Hh, Ft, Oh, Kk, Tc	24 h	Yes	Yes	
OHIG43	2006/Feb/08	Ho, Hh, Ft, Oh, Kk, Tc	24 h	Yes	Yes	(J47)
OHIG44	2006/Feb/14	Ho, Hh, Ft, Oh, Kk, Tc	24 h	Yes	Yes	
OHIG45	2006/Nov/07	Ho, Hh, Ft, Oh, Kk, Tc	24 h	Yes	Yes	
OHIG46	2006/Nov/14	Ho, Hh, Oh, Kk, Tc	24 h	Yes	Yes	
OHIG47	2006/Nov/29	Ho, Hh, Ft, Oh, Kk, Tc	24 h	Yes	Yes	
OHIG49	2007/Feb/13	Ho, Hh, Ft, Oh, Kk, Tc	24 h	Yes	Yes	(J48)
OHIG51	2007/Nov/06	Ho, Ft, Oh, Kk, Tc	24 h	Yes	Yes	
OHIG52	2007/Nov/07	Ho, Ft, Oh, Kk, Tc	24 h	Yes	Yes	
OHIG53	2007/Nov/13	Ho, Hh, Ft, Oh, Kk, Pa, Tc	24 h	Yes	Yes	
OHIG54	2007/Nov/14	Ho, Hh, Ft, Oh, Kk, Pa, Tc	24 h	Yes	Yes	
OHIG55	2008/Feb/06	Hh, Oh, Kk, Tc	24 h	Yes	Yes	(J49)
OHIG56	2008/Feb/12	Hh, Oh, Kk, Tc	24 h	Yes	Yes	
OHIG57	2008/Feb/13	Hh, Oh, Kk, Tc	24 h	Not yet	Not yet	
OHIG59	2008/Nov/12	Ho, Ft, Oh, Kk, Tc	24 h	Not yet	Not yet	
OHIG60	2008/Nov/18	Ho, Ft, Oh, Kk, Pa, Tc, Ts	24 h	Not yet	Not yet	
OHIG61	2008/Nov/19	Ho, Ft, Oh, Kk, Tc	24 h	Not yet	Not yet	

45: DSS45, Ts: Tsukuba32

(J45) JARE-45: op K. Doi eng. K. Fukuhara (J46) JARE-46: op K. Egawa eng I. Okabayashi

(J47) JARE-47: op T. Sawagaki eng H. Ishii (J48) JARE-48: op N. Arai eng H. Sugawara

(J49) JARE-49: op Y. Aoyama eng H. Kumagai

## 5. Analysis Results

As of the end of February 2009, 63 sessions from May 1999 through February 2008 have been analyzed with the software CALC/SOLVE developed by NASA/GSFC. The data of 4 OHIG sessions from OHIG57 through OHIG61 will be analyzed soon.

The length of the Syowa-Hobart baseline is increasing with a rate of  $54.7 \pm 0.4$  mm/yr. The Syowa-HartRAO baseline shows a slight increase with a rate of  $11.7 \pm 0.3$  mm/yr. These results agree approximately with those of GPS. The Syowa-O'Higgins baseline shows also slight increase, although the rate is only  $1.7 \pm 0.9$  mm/yr. Detailed results from the data until the end of 2003 as well as comparisons with the results from other space geodetic techniques are reported in [3].

## References

- [1] Shibuya, K., Doi, K., and Aoki, S. (2003): Ten years' progress of Syowa Station, Antarctica, as a global geodesy network site. *Polar Geoscience*, 16, 29-52.
- [2] Shibuya, K., Doi, K., and Aoki, S. (2002): JARE Syowa Station 11-m Antenna, Antarctica, in *International VLBI Service for Geodesy and Astrometry 2002 Annual Report*, 149-152, NASA/TP-2003-211619, ed. by N. R. Vandenberg and K. D. Baver.
- [3] Fukuzaki, Y., Shibuya, K., Doi, K., Ozawa, T., Nothnagel, A., Jike, T., Iwano, S., Jauncey, D.L., Nicolson, G.D., and McCulloch, P.M. (2005): Results of the VLBI experiments conducted with Syowa Station, Antarctica. *J. Geod.*, 79, 379-388.

## Geodetic Observatory TIGO in Concepción

*Sergio Sobarzo, Eric Oñate, Cristóbal Jara, Cristian Herrera, Pedro Zaror,  
Cristian Duguet, Miguel Soto, Hayo Hase, Armin Böer, Bernd Sierk*

### Abstract

During the seventh year of operation in Chile, TIGO carried out 110 successful VLBI observations. Activities of the VLBI group at TIGO during 2008 and an outlook for 2009 are given.

### 1. General Information

The operation of TIGO is based on a bilateral agreement between Chile and Germany in which:

- Universidad de Concepción
- Instituto Geográfico Militar
- Bundesamt für Kartographie und Geodäsie

are cooperating. TIGO is located near the Universidad de Concepción, at longitude 73.025 degrees West and latitude 36.843 degrees South, 500 kilometers south of Santiago, the Chilean capital.

### 2. Component Description

The IVS network station TIGOCONC is the VLBI part of the Geodetic Observatory TIGO, which was designed to be a fundamental station for geodesy. Hence the VLBI radiotelescope is co-located with an SLR telescope (ILRS site), a GPS/Glonass permanent receiver (IGS site) and other instruments such as water vapor radiometer, seismometer, superconducting gravity meter and absolute gravity meter.

The atomic clock ensemble of TIGO consists of three hydrogen masers, three cesium clocks and three GPS time receivers, realizing the Chilean contribution to the Universal Time scale (Circular T, BIPM).

The technical parameters of the TIGO radiotelescope as published in [1] have not been changed.

### 3. Staff

During this year Carlos Verdugo terminated his job in TIGO and was replaced by Pedro Zaror as a mechanical engineer. Two electronic engineer students also joined the VLBI team this year: Cristian Duguet and Miguel Soto. The 2008 TIGO VLBI group consisted of the persons listed in table 1.

### 4. Current Status and Activities

During 2008 TIGO was scheduled to participate in 110 IVS experiments (see table 2) and one 24-hour experiment framed by the TANAMI program [2]. TIGO also participated in its second CONT campaign with 15 days of continuous observations.



Figure 1. Current VLBI Staff (Sobarzo, Oñate, Neumann, Zaror, Duguet, Jara, Herrera, Hase and Soto).

On May 22nd, TIGO took part in the first four continent real-time e-VLBI observation as part of the TERENA Networking Conference 2008. This time TIGO, with the joint effort of the REUNA and CLARA educational networks, could reach 64 Mbps of sustained data rate throughout the run of the demo. (See figure 2.)

This year Sergio Sobarzo finished his Doctoral Thesis named *Multipath Routing for e-VLBI* [3]. The development allows the attainment of higher available bandwidths using different paths between the observing station and the correlator. The system also has a custom load control in order to balance the used bandwidth according to network conditions, e.g., the delay. In figure 3 the increase in the resulting throughput by using two different paths can be seen.

These achievements are proofs of concept, but their application to production e-VLBI is not yet deployed.

## 5. Future Plans

The VLBI activities in 2009 will be focused on:

- execution of the IVS observation program for 2009
- continuation of developments:
  - investigations related to e-VLBI
  - new monitor and control system for the receiver
- repetition of the local survey



Table 1. TIGO-VLBI support staff in 2008.

Staff	Function	Email
Hayo Hase	Head	hayo.hase@tigo.cl
Sergio Sobarzo	Chief Engineer	sergio.sobarzo@tigo.cl
Eric Oñate	Electronic Engineer	eric.onate@tigo.cl
Cristóbal Jara	Electronic Engineer	crisobal.jara@tigo.cl
Cristian Herrera	Information Engineer	cristian.herrera@tigo.cl
Pedro Zaror	Mechanical Engineer	pedro.zaror@tigo.cl
Cristian Duguet	Electronic Engineer	cristian.duguet@tigo.cl
Miguel Soto	Electronic Engineer	miguel.soto@tigo.cl
Jenny Neumann	Secretary	jenny.neumann@tigo.cl
any VLBI operator	on duty	vlbi@tigo.cl
all VLBI operators		vlbistaff@tigo.cl

Table 2. TIGO's IVS observation statistics for 2008.

Name	# of Exp.	OK	Failed
R1xxx	25	25	0
R4xxx	50	50	0
R&D	6	6	0
OHIGxx	7	7	0
T20xx	7	7	0
Tanami	1	1	0
C08xx	15	14	1
Total IVS	111	110	1

## References

- [1] Vandenberg, N.R.: International VLBI Service for Geodesy and Astrometry 1999 Annual Report, NASA/TP-1999-209243, 1999.
- [2] M. Kadler, R. Ojha, S. Tingay and J. Lovell, *The TANAMI Program: Southern Hemisphere VLBI Monitoring of Relativistic Jets in Active Galaxies*, American Astronomical Society, AAS Meeting #211, #04.13; Bulletin of the American Astronomical Society, Vol. 39, p.732.
- [3] Sergio K. Sobarzo, Sergio N. Torres and Hayo Hase, *Multipath Routing for e-VLBI*, paper submitted to Computer and Geosciences Journal, Elsevier.

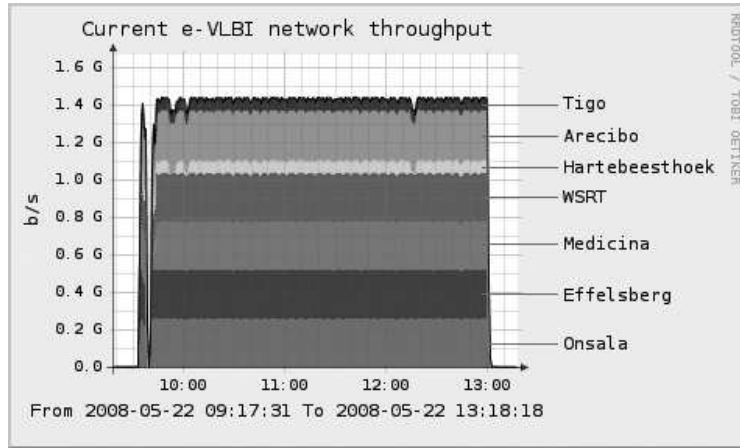

Figure 2. Resulting throughput of all telescopes involved in the TERENA Networking Conference 2008 demo.

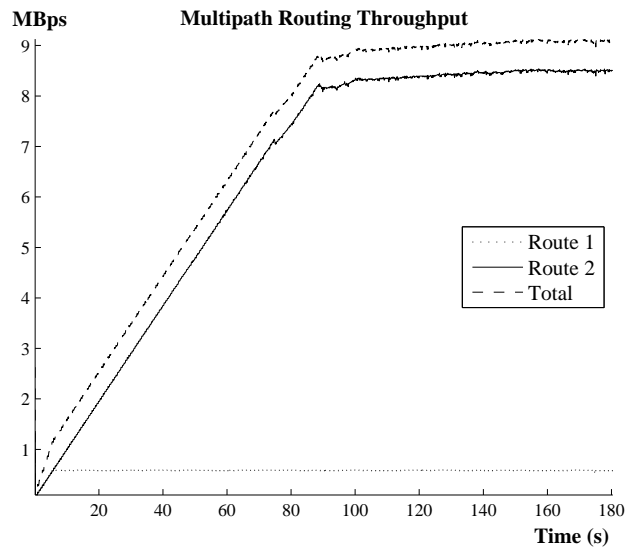

Figure 3. Resulting throughput obtained by using two different paths between TIGO and JIVE networks.

## Tsukuba 32-m VLBI Station

*Daisuke Tanimoto, Shinobu Kurihara, Kensuke Kokado, Shigeru Matsuzaka*

### Abstract

The Tsukuba 32-m radio telescope is operated by the Geographical Survey Institute (GSI) VLBI group. This report summarizes the current status and the future plans of the Tsukuba 32-m VLBI station.

We participated in a total of 208 domestic and international VLBI sessions in accordance with the IVS 2008 observing plan. The CONT08 campaign in August was the highlight of the year. In experimental sessions in 2008, we achieved an extremely rapid UT1 measurement latency of 3 minutes 45 seconds for an ultra-rapid dUT1 experiment in February. We started 32 Mbps/ch observing using K5/VSSP32 this year.

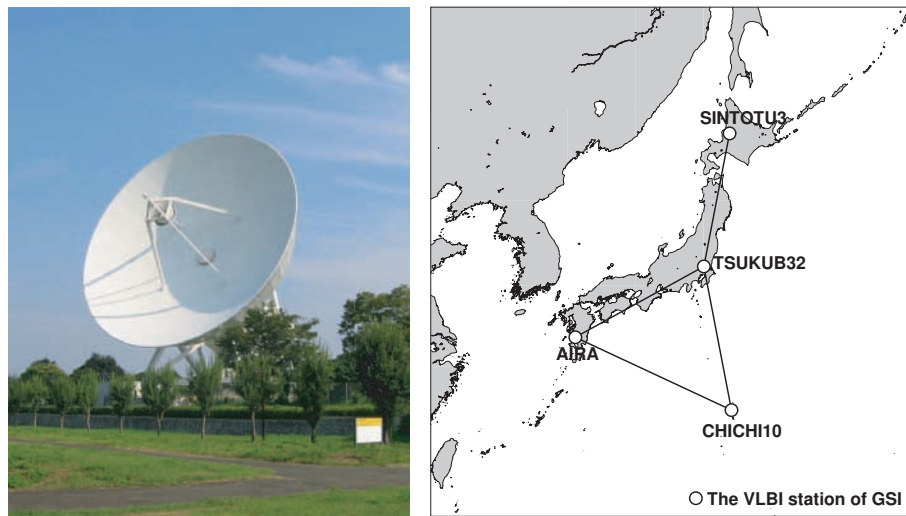

Figure 1. Tsukuba 32-m VLBI station and GARNET (GSI VLBI network).

### 1. General Information

The Tsukuba 32-m VLBI station (TSUKUB32) is located at GSI in Tsukuba Science City, which is about 50 km to the northeast of the capital Tokyo.

GSI has four VLBI stations; TSUKUB32, AIRA, CHICHI10, and SINTOTU3. These four stations form our domestic VLBI network named GARNET (GSI Advanced Radio telescope NETwork). We have performed our domestic VLBI observations using GARNET. One series of sessions is named JADE (Japanese Dynamic Earth observation by VLBI). The main purposes of the JADE series are to define the reference frame of Japan and to monitor the plate motions for the advanced study of crustal deformations. The GARNET stations, centered on TSUKUB32, are located to cover the Japanese mainland. The GARNET stations other than TSUKUB32 joined international VLBI sessions this year.

## 2. Component Description

In 2007, we completed the installation and adjustment of K5/VSSP32, which enables us to record at up to 32 Mbps/ch. In April 2008, we started observing with the recording speed of 32 Mbps/ch. It is possible for us to sample 32 MHz/1-bit data and 16 MHz/2-bit data. We modified some related scripts in K5 and FS computers for 2-bit sampling. K5/VSSP32 is working well now.

We have an “e-VLBI” network which is capable of transferring the huge amount of VLBI data with a high transfer rate. In 2007, we started e-VLBI transfers in practice. In September 2008, the Tsukuba e-VLBI network joined SINET3 (the Science Information NETwork 3) and renovated some equipment. We have been regularly transferring VLBI data via the e-VLBI network from/to the Bonn correlator, the Wettzell station and the Haystack observatory. The transfer rate between Tsukuba and Bonn is 600 Mbps now.

In December 2008, we introduced a remote-control switch which can change the wiring of the backend IF cable. We added remote-control of the switch to the Field System; therefore we do not need to set up the wiring before observations manually now. This means that we can observe continuously automatically, for example, for the case of IVS-R1 (X-band: wide) and IVS-T2 (X-band: narrow, 30 minutes after R1). It is very convenient, because the start time of these sessions is midnight in Japan.

## 3. Staff

Table 1 shows the regular operating staff of GSI’s VLBI observation group.

Morito Machida (former operation chief) moved to a different section and Etsuro Iwata (former network chief) retired from GSI in April. Kazuhiro Takashima came back to GSI as a senior researcher after a year. He is a member of the IVS Directing Board (Networks Representative). Yasuko Mukai came as the new staff member for routine observation and correlation. Routine operations were mainly performed under contract with Advanced Engineering Service Co., Ltd (AES).

The information on the correlator staff are listed in the correlator section of this volume.

Table 1. Staff list of the GSI VLBI group

Name	Position
Shigeru MATSUZAKA	Head of Space Geodesy Division
Kozin WADA	Deputy head of Space Geodesy Division
Shinobu KURIHARA	Responsible official
Kensuke KOKADO	Technical staff (Observation and Analysis)
Daisuke TANIMOTO	Technical staff (Observation)
Yasuko MUKAI	Technical staff (Observation and Correlation)
Toshio NAKAJIMA	Network staff
Yoshihiro FUKUZAKI	Technical manager
Kazuhiro TAKASHIMA	Senior researcher, IVS DB



Figure 2. VLBI member group photo

#### 4. Current Status and Activities

The regular sessions from the IVS 2008 master schedule are shown in Table 2. TSUKUB32 participated in a total of 208 domestic and international VLBI (IVS) sessions in this year.

CONT08 is a two week campaign of continuous VLBI sessions. We participated in this challenging campaign during the second half of August. The recording speed was 32 Mbps/ch. We observed by K5/VSSP32. Two IVS-R&D sessions provided a test of the 32 Mbps/ch recording before CONT08. Since CONT08, the live camera page for the Tsukuba 32-m VLBI antenna has been uploaded to our Web site at:

<http://vldb.gsi.go.jp/sokuchi/vlbi/en/antscan/index.php>

Additionally, we participated in one IVS-OHIG session for the first time in November.

In the past, TSUKUB32 had been the only one of the GARNET stations to participate in international VLBI sessions. This year, AIRA and CHICHI10 joined IVS-T2 sessions, and AIRA, CHICHI10, and SINTOTU3 joined APSG sessions. This means that AIRA, CHICHI10 and SINTOTU3 have connected to the international VLBI network directly.

We changed the frequency sequence from X8/S8 to X10/S6 starting in the November JADE session. The increased X-band channels are LSB of channels 1 and 8. This is the same as international VLBI sessions such as IVS-R1 and IVS-T2. Moreover, we performed the 2-bit sampling in the November JADE session.

Table 2. The regular (IVS) sessions at Tsukuba 32-m VLBI station in 2008

Sessions	Codes	Number
IVS-R1	r1310, r1313, ... , r1357	31
IVS-T2	t2053, t2055, t2058, t2059	4
APSG	apsg22, apsg23	2
VLBA	rdv67, rdv71, rdv72	3
CONT08	c0801, ... , c0815	15
IVS-R&D	rd0803, rd0804	2
IVS-OHIG	ohig60	1
JADE	jd0801, ... , jd0808, jd0811	9
IVS-INT2	k08005, k08006, ..., k08363	99
IVS-INT3	k08042, k08049, ..., k08357	42
Total		208

The experimental sessions in 2008 are shown in Table 3.

We carried out a total of 18 (4 days) ultra-rapid dUT1 experiments in this year. Ultra-rapid dUT1 experiments are experimental sessions using e-VLBI technology. We observed using the baseline between Japan (Tsukuba and Kashima) and Fennoscandia (Onsala and Metsähovi). The huge amount of VLBI data is transferred from Fennoscandia to Japan near real-time. The goal is to obtain the UT1 results as rapidly and as stably as possible. We succeeded in obtaining dUT1 only 3 minutes 45 seconds after the end of the observing session with Onsala on Feb. 21, 2008. Since April, we have recorded 32 Mbps/ch with a 512 Mbps transfer rate.

GSI and NICT (National Institute of Information and Communications Technology) are developing a compact VLBI system with a 1.6 m diameter aperture dish (MARBLE; Multiple Antenna Radio-interferometry of Baseline Length Evaluation) in order to provide reference baseline lengths for GPS and EDM calibrations. We have evaluated a front-end system with a wide-band quad-ridged horn antenna (QRHA) by installing it on the 2.4 diameter dish at Kashima (CARAVAN2400). Three geodetic VLBI experiments on the 54 km baseline between the Tsukuba 32-m and CARAVAN2400 with the QRHA were carried out, and we succeeded in obtaining the baseline length results.

In addition, we performed special geodetic VLBI sessions in January and June intended for determining more precise positions for the UCHINOOR and USUDA64 antennas owned by Japan Aerospace Exploration Agency (JAXA).

Table 3. The experimental sessions at Tsukuba 32-m VLBI station in 2008

Session	Code	Number
Ultra-rapid dUT1 experiment	u8052t, u8052a-d, u8113a, u8113b, t8193a-f, u08245s, u08245a-c, k08245	18 (4 days)
UCHINOOR geodetic experiment	u08020	1
USUDA64 geodetic experiment	u08170	1
CARAVAN2400 geodetic experiment	ca8121, ca8175, ca8184	3

We performed a local tie survey at TSUKUB32 in February and at AIRA in October and November.

## 5. Future Plans

Tsukuba 32-m, AIRA, CHICHI10 and SINTOTU3 will also participate in many IVS sessions in 2009. To keep getting high quality VLBI data, we will try to renovate and improve our VLBI equipment. We have obtained the necessary budget for renewing a current hydrogen maser and for purchasing a high-speed digital sampler “ADS3000 plus”. Furthermore the working prototypes of the MARBLE system will be completed, and we will be able to carry out test geodetic VLBI experiments using the MARBLE system in 2009. As for our network infrastructure, speeding up of the SINET3 is under consideration.

# Nanshan VLBI Station Report for 2008

*Aili Yusup, Xiang Liu*

## Abstract

The Nanshan 25-meter radio telescope is operated by Urumqi Observatory. This report describes the activities and the status of Nanshan VLBI station as an IVS network station in 2008.

## 1. Introduction

The station is located 70 km south of Urumqi, the capital city of Xinjiang Uygur Autonomous Region of China. The station is affiliated with the Urumqi Observatory of the National Astronomical Observatories, CAS. We contribute to IVS in geodetic VLBI observations. The Nanshan VLBI station has participated in domestic VLBI experiments and as one of the VLBI ground stations tracking the Chinese Chang'E satellite. Urumqi also participated in the Japanese SELENE observations. The telescope participated in real-time experiments among the Chinese VLBI Network. We are grateful for the kind help and support from the VLBI experts within the IVS community. The Urumqi Observatory is willing to continue the collaboration in international VLBI activities.

## 2. Telescope Status

### 2.1. Antenna

- Diameter: 25 meter
- Antenna type: Modified Cassegrain
- Seat-rack type: Azimuth-pitching ring
- Main surface precision: 0.40 mm (rms)
- Pointing precision: 15'' (rms)
- Rolling range: Azimuth:  $-270^\circ$  to  $270^\circ$ ; Elevation:  $5^\circ$  to  $88^\circ$
- Maximum rolling speed: Azimuth:  $1.0^\circ/\text{sec}$ ; Elevation:  $0.5^\circ/\text{sec}$

### 2.2. Receivers

The basic specifications of the receivers and the antenna sensitivity are given in Table 1.

### 2.3. Recording System

Mark 5A, Mark IV, Mark II, and K5 recording systems are available at the Nanshan VLBI station. The performance of the observing system has been improved over the last year. The Field System has been upgraded to version 9.10.3, and it works well. A DBBC System that had been at Shanghai Astronomical Observatory (SHAO) was installed at Urumqi for the Chinese Chang'E lunar project in 2008.

Table 1. Specifications of receivers

Parameters				Freq. Range (MHz)
1.3 cm	LCP	T <sub>sys</sub> =190K	DPFU=0.057	22100–24000
3.6 cm	RCP	T <sub>sys</sub> =50K	DPFU=0.093	8100–8900
6 cm	dual	T <sub>sys</sub> =22K	DPFU=0.11	4700–5110
13 cm	RCP	T <sub>sys</sub> =70K	DPFU=0.096	2150–2450
18 cm	dual	T <sub>sys</sub> =24K	DPFU=0.088	1400–1720
30 cm	LCP	T <sub>sys</sub> =160K	DPFU=0.06	800–1200
49 cm	dual	T <sub>sys</sub> =?	DPFU=?	560–660
92 cm	dual	T <sub>sys</sub> =?	DPFU=?	305–345

## 2.4. Time and Frequency System

The No.11 H-maser was upgraded at SHAO, and it is now in good status. The other two H-masers, the MHM2010 imported from the Symmetricom company in the United States and the No. 13, work well. The time and frequency comparison system operates continuously.

## 3. Activities during 2008

### 3.1. Geodetic VLBI Observations

Nanshan participated in eight geodetic VLBI sessions, and all experiments were recorded using Mark 5A. The details are listed in Table 2 below. All geodetic 24-hour experiments of 2008 were completed without problems.

Table 2. Geodetic VLBI experiments observed by Urumqi Observatory during 2008.

Experiment	Date	Remarks (problems)
T2054	03.01	OK
T2055	06.24	OK
T2056	07.29	OK
T2057	09.23	OK
T2058	11.11	OK
T2059	12.16	OK
APSG22	09.09	OK
APSG23	10.08	OK

### 3.2. International e-VLBI Activities

Urumqi was connected at 622 Mbps to CSTnet on December 15, and CSTnet opened the international network to JIVE. A number of e-VLBI test experiments were performed at the rate of 512 Mbps between Urumqi and Shanghai from December 15 onward. The international



connection between Urumqi, Shanghai, and JIVE successfully achieved a data rate of 512 Mbps on December 19, 2008, and fringes were detected among Urumqi, Shanghai, European, and Australian telescopes on December 22, 2008.

#### 4. Personnel

Table 3. The main staff at Nanshan VLBI Station

Name	Position	Working area	e-mail
Na Wang	Professor	Station chief	na.wang@uao.ac.cn
Aili Yusup	Professor	Chief engineer	aliyu@uao.ac.cn
Zhengwen Sun	Senior engineer	Microwave, Receiver	sunzw@uao.ac.cn
Xiang Liu	Professor	VLBI friend	liux@uao.ac.cn
Yousuo Dong	Senior engineer	Antenna control	dongys@uao.ac.cn
Maozheng Chen	Senior engineer	Receiver	mzchen@uao.ac.cn
Aili Esamdin	Scientist	Astronomy	aliyi@uao.ac.cn
Jarken Yesembek	Scientist	Astronomy	jerken@uao.ac.cn
Weixia Wang	Senior engineer	Receiver	wangwx@uao.ac.cn
Minghui Shao	Senior engineer	Time and Freq., Terminal	shaomh@uao.ac.cn
Wenjun Yang	Engineer	Terminal	yangwj@uao.ac.cn
Shiqiang Wang	Engineer	Antenna	Wangshq@uao.ac.cn
Hua Zhang	Engineer	Terminal, Time and Freq.	zhangh@uao.ac.cn
Guanghui Li	Engineer	Network, Computer	ligh@uao.ac.cn
Jun Ma	Engineer	Receiver	majun@uao.ac.cn
Chenyu Chen	Engineer	Antenna	chency@uao.ac.cn
Xiangfeng Wang	Engineer	Network, Computer	wangxf@uao.ac.cn

#### 5. Future Plans

In 2009, a new 1.3 cm dual polarization cryogenic receiver will be completed. Dual band receivers for both 92 cm and 49 cm were completed last year and will be further tested. A room temperature 13 cm dual polarization receiver is being built. A new Mark 5B+ recording system will be used at the end of 2009. The S/X band feed horn will be replaced by a new one this year.

# Westford Antenna

*Mike Poirier*

## Abstract

Technical information is provided about the antenna and VLBI equipment at the Westford site of Haystack Observatory and about changes to the systems since the IVS 2007 Annual Report.

## 1. Westford Antenna at Haystack Observatory

Since 1981 the Westford antenna has been one of the primary geodetic VLBI sites in the world. Located  $\sim 70$  km northwest of Boston, Massachusetts, the antenna is part of the MIT Haystack Observatory complex.



Figure 1. The radome of the Westford antenna.

Table 1. Location and addresses of Westford antenna.

Longitude	71.49° W
Latitude	42.61° N
Height above m.s.l.	116 m
MIT Haystack Observatory Off Route 40 Westford, MA 01886-1299 U.S.A. <a href="http://www.haystack.mit.edu">http://www.haystack.mit.edu</a>	

The Westford antenna was constructed in 1961 as part of the Lincoln Laboratory Project Westford that demonstrated the feasibility of long-distance communication by bouncing radio signals off a spacecraft-deployed belt of copper dipoles at an altitude of 3,600 km. In 1981 the antenna was converted to geodetic use as one of the first two VLBI stations in the National Geodetic Survey Project POLARIS. Westford has continued to perform geodetic VLBI observations on a regular

basis since 1981. Westford has also served as a test bed in the development of new equipment and techniques now employed in geodetic VLBI worldwide. Primary funding for geodetic VLBI at Westford is provided by the NASA Space Geodesy Program.

## 2. Technical Parameters of the Westford Antenna and Equipment

The technical parameters of the Westford antenna, which is shown in Figure 2, are summarized in Table 2.

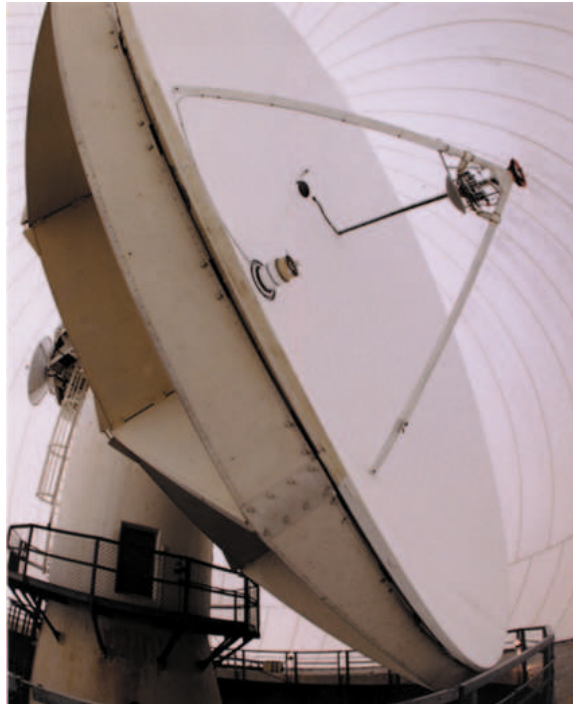

Figure 2. Wide-angle view of Westford antenna inside the radome. The VLBI S/X receiver is located at the prime focus. The subreflector in front of the receiver is installed when observing with the TAL receiver (see Section 4), which is located at the Cassegrain focus.

The antenna is enclosed in a 28-meter diameter, air-inflated radome made of 1.2-mm thick, Teflon-coated fiberglass — see Figure 1. When the radome is wet, system temperatures increase by 10–20 K at X-band and by a smaller amount at S-band. The major components of the VLBI data acquisition system are a Mark IV electronics rack, a Mark 5B recording system, and a Pentium-class PC running PC Field System version 9.10.2. The primary frequency and time standard is the NR-4 hydrogen maser. A CNS Clock GPS receiver system provides independent timing information and comparisons between GPS and the maser. Westford also hosts the WES2 GPS site of the IGS network. A Dorne-Margolin choke ring antenna is located on top of a tower ~60 meters from the VLBI antenna, and an Ashtech Model-Z Reference Station receiver acquires the GPS data.

Table 2. Technical parameters of the Westford antenna for geodetic VLBI.

<i>Parameter</i>	<i>Westford</i>	
primary reflector shape	symmetric paraboloid	
primary reflector diameter	18.3 meters	
primary reflector material	aluminum honeycomb	
S/X feed location	primary focus	
focal length	5.5 meters	
antenna mount	elevation over azimuth	
antenna drives	electric (DC) motors	
azimuth range	90° – 470°	
elevation range	4° – 87°	
azimuth slew speed	3° s <sup>-1</sup>	
elevation slew speed	2° s <sup>-1</sup>	
	<i>X-band system</i>	<i>S-band system</i>
frequency range	8180-8980 MHz	2210-2450 MHz
$T_{sys}$ at zenith	50–55 K	70–75 K
aperture efficiency	0.40	0.55
SEFD at zenith	1400 Jy	1400 Jy

### 3. Westford Staff

The personnel associated with the VLBI program at Westford and their primary responsibilities are:

Chris Beaudoin	broadband development
Joe Carter	antenna controls
Brian Corey	VLBI technical support
Kevin Dudevoir	pointing system software
Dave Fields	technician, observer
Glenn Millson	observer
Arthur Niell	principal investigator
Michael Poirier	site manager
Alan Whitney	site director

### 4. Status of the Westford Antenna

From 2008 January 1 through 2008 December 31 Westford participated in 60 standard 24-hour geodetic sessions along with the 15-day continuous CONT08 session. Westford regularly participated in the IVS-R1, IVS-R&D, and the RD-VLBA sessions along with fringe tests, e-VLBI experiments, and VLBI2010 broadband development testing.

Use of the Westford antenna is shared with the Terrestrial Air Link (TAL) Program operated by the MIT Lincoln Laboratory. In this project Westford serves as the receiving end on a 42-km-long terrestrial air link designed to study atmospheric effects on the propagation of wideband communications signals at 20 GHz.

## 5. e-VLBI Development at Westford

Westford continues to play a key role in the development of e-VLBI. During 2008, Westford served as a test bed for continued high-speed e-VLBI development in testing the application for the new Mark 5B+ system to achieve real-time playback. Unfortunately, there was a reduction in Westford's available data rate to the outside world to 1 Gbps over a shared network due to the end of support of the NSF DRAGON project at MAX and the loss of the BOSSNET connection to Internet2 in Maryland. The impact on e-VLBI was that real-time experiments with other correlators, though attempted, were unsuccessful. The outlook for Westford in 2009 is that it will continue to play a crucial role in e-VLBI development for VLBI2010 and the broadband development effort as the Mark 5C and DBEv2 programs release equipment.

## 6. VLBI2010

During 2008 we constructed a broadband feed system for the Westford Antenna. The dewar design is a duplicate of the system on the MV-3 antenna except that the mount design is specific to the Westford prime focus location. We now have a full complement of broadband equipment that includes four Mark 5b+s, four Up/Down Converters, four DBEs, and one ORCA box, all dedicated to this development effort. We have recently been making single dish measurements using satellite signals to improve the focusing and pointing. VLBI observations have been successful with fringes detected at various times in bands spanning 3.5 - 9 GHz. We will continue testing and expect fringes over the whole currently available range 3.1 - 11.5 GHz which will enable us to better understand this broadband development.

## 7. Outlook

Westford is expected to participate in 68 24-hour geodetic sessions in 2009. We also plan to have the flexibility to support the occasional fringe test and e-VLBI experiments while continuing the VLBI2010 broadband development testing.

# Fundamentalstation Wettzell - 20m Radiotelescope

*Alexander Neidhardt, Gerhard Kronschnabl, Raimund Schatz*

## Abstract

The 20m-radiotelescope at Wettzell, Germany again contributed very successfully and strongly to the IVS observing program in 2008. Technical changes, improvements, and upgrades were made to increase the reliability of the entire VLBI observing system.

## 1. General Information

The 20m-Radiotelescope in Wettzell (RTW) was designed in the years 1980/81 as a project of the former “Sonderforschungsbereich 78 Satellitengeodäsie”. RTW is an essential component of the Fundamentalstation Wettzell (FSW) and is jointly operated by Bundesamt für Kartographie und Geodäsie (BKG) and Forschungseinrichtung Satellitengeodäsie (FESG) of Technical University Munich. In addition to the 20m RTW at the Fundamentalstation Wettzell (FSW), the following geodetic space technique systems are co-located:

- laser ranging systems involved in ILRS: WLRS (Wettzell Laser Ranging System) and a new implementation called Satellite Observing System Wettzell (SOSW) is under construction.
- GPS receivers involved in global network IGS, in the European network EUREF, in the national network GREF, and in time transfer experiments.
- G, a large lasergyroscope or ringlaser dedicated for monitoring of daily variations of Earth rotation.

A time and frequency system (T&F) is established for the generation of the timescale UTC(IfAG) and for the provision of very precise frequencies needed for VLBI, SLR/LLR and GPS observations. Cs-clocks, H-Masers and GPS time receivers are employed. The time scale UTC(IfAG) is published in the monthly Bulletin T of BIPM. Additional in situ observations are carried out, such as gravity observations with a super conducting gravity meter, recording of earthquakes with a seismometer, and meteorological observations to monitor pressure, temperature and humidity including wind speed, wind direction and rain fall. Continuously water vapour observations with a Radiometrix radiometer are carried out. Periodically conventional geodetic control measurements are performed to tie the reference points of the space geodetic systems RTW, WLRS, GPS, and “G” to the local terrestrial coordinate system and to investigate the local stability.

## 2. Staff

The staff of the Fundamentalstation Wettzell consists in total of 35 members for operations, maintenance and repair issues and for improvement and development of the systems. Within the responsibility of the Fundamentalstation Wettzell are also the TIGO systems (see report in this volume), operated in Concepción, Chile by three BKG experts jointly with a Chilean partner consortium (support staff: 11 engineers), and the O’Higgins station (see report in this volume) in Antarctica, jointly operated with the German Space Center (DLR) and the Institute for Antarctic Research Chile (INACH).

The staff operating RTW is summarized in table 1. In July 2008 Dr. Alexander Neidhardt took over the position of group leader and VLBI station chief at the RTW. He is also still involved in the developments at the Satellite Observing System Wettzell (SOSW), where he develops the new automated and remotely accessible control system together with the SOSW team. The former, now retired head of the RTW team, Richard Kilger, still supports the TWIN-project as an adviser, and he took part in the VLBI campaign at the German Antarctic Receiving Station O'Higgins in January and February 2008.



Figure 1. The Wettzell VLBI crew (from left to right): C. Plötz, E. Bauernfeind, G. Kronschnabl, R. Schatz, W. Schwarz, R. Zeitlhöfler, A. Neidhardt (missing from picture: E. Bielmeier).

Table 1. Staff - members of RTW

Name	Affiliation	Function	Working for
Wolfgang Schlüter	BKG	head of the FSW (until July 2008)	FSW
Johannes Ihde	BKG	interim head of the FSW (since August 2008)	FSW
Alexander Neidhardt	FESG	group leader and VLBI station chief RTW	RTW, SOSW (partly O'Higgins)
Erhard Bauernfeind	FESG	mechanical engineer	RTW
Ewald Bielmeier	FESG	technician	RTW
Gerhard Kronschnabl	BKG	electronic engineer	RTW (partly TIGO and O'Higgins)
Christian Plötz	BKG	electronic engineer	O'Higgins, RTW
Raimund Schatz	FESG	software engineer	RTW
Walter Schwarz	BKG	electronic engineer	RTW (partly O'Higgins and WVR)
Reinhard Zeitlhöfler	FESG	electronic engineer	RTW
Daniel Helmbrecht	FESG/BKG	student	RTW
Alexander Bauer	FESG/BKG	student	RTW

### 3. Observations in 2008

The 20m-RT-Wettzell has supported geodetic VLBI activities for over 25 years. All successfully observed sessions in the year 2008 are summarized in table 2. According to the IVS 2008 Master Schedule, RTW was the station that was scheduled for the most 24-hour geodetic VLBI sessions, which has been true for nine years. The daily one-hour INTENSIVE sessions (INT) were continued

in addition to the 24-hour sessions in order to determine UT1-UTC. These sessions, observed together with Kokee Park Observatory since 1999, are called INT1 and are performed every weekday. The correlation is done at the Washington Correlator (WASH). On Saturday and Sunday RTW is scheduled for the INT2/K sessions together with Tsukuba, Japan, filling the weekend gap from Sunday morning to Monday evening. Since August 2008, INT3/K has been set up on Monday morning, in order to shorten the weekend gap. INT2/K and in particular INT3/K provide regular UT1-UTC results with shortest latency. INT3/K includes the network stations Wettzell, Tsukuba and Ny-Ålesund. INT2/K data are correlated at the VLBI correlator in Tsukuba; INT3/K data are correlated in Bonn. Both VLBI correlators have a fast internet connection and are able to receive the data from the observing stations via e-VLBI in near real time via e-transfer. RTW now routinely uses the increased internet connection capacities of 622 Mbit/sec for the e-transfers to Bonn, Tsukuba and Haystack. The data transfer via Internet to the Washington Correlator is still organized via a center in the Washington area. The last mile problem is solved by car transport to the correlator.

In the year 2008 the RTW also took part in the Continuous VLBI Campaign 2008 (CONT08) where a continuous measurement over 15 days from August 12, 2008 until August 26, 2008 was run successfully. Except for a short gap of three hours caused by an IT problem, the RTW was fully operative during the whole observation period.

Table 2. RTW observations in 2008

program	number of 24h-sessions	program	number of 1h-sessions
IVS R1	49	INT1(Kokee-RTW)	234
IVS R4	51	INT2/K(Tsukuba-RTW)	100
IVS T2	6	INT3/K(Tsukuba-RTW-NyAl)	41
IVS R&D	9	<b>total (in hours)</b>	<b>375</b>
RDV/VLBA	6		
EUROPE	5	<b>special program</b>	<b>number of experiments</b>
CONT08	15	SELENE	19
<b>total</b>	<b>141</b>	<b>total (in hours)</b>	<b>92</b>
<b>total (in hours)</b>	<b>3384</b>		

In addition to the routinely done observations, Wettzell also supported the SELENE mission done by the National Astronomical Observatory of Japan with 92 hours of observation. SELENE is a Lunar Project to improve the determination of the gravity field of the moon.

According to the implementation of a Field System extension for remote control of the system, eleven INT2/INT3 experiments were done by remote control. In addition to that, the weekend observations are partly done unattended at Wettzell.

#### 4. Technical Improvements and Maintenance

VLBI observations require high reliability of all participating stations; therefore careful servicing of all components is essential to ensure successfully performed VLBI measurements through the year(s). Additionally the 20m-RTW has to be kept to a high technical standard and has to be improved according to technological advancement.

In 2008 the following actions were carried out:

- Integration of a testbed for the new digital baseband converter (DBBC) with:



- installation of the hardware with the core1 boards and reception of the core2 DBBCs
- first recording and correlation tests in cooperation with the correlator at Bonn
- first software implementation for an integration of the DBBC control into station specific Field System modules
- Establishment of a new e-VLBI storage buffer as a RAID6 system with effectively 60 TBytes of space containing:
  - the installation of a test system with 16 TBytes of space
  - a highly available storage area network based on two servers, with a RAID system of 96x 750 GByte SATA-drives
  - NFS-mount via the EVN-PC installation to stream data to the storage area (including the first complete recording of CONT08)
- Establishment of Mark 5B with:
  - an update of the formatter as VSI4 to support Mark 5B
  - installation of Mark 5B hardware and first recording tests
- Improvement of the replacement dewar (done by the retired Richard Kilger) with:
  - reorganization of the interior with a stable framework
  - improvement of the thermal shield for the 20K level
- Software implementations for a remotely controllable extension for the Field System and first remote control tests with Wettzell and O'Higgins and TIGO
- Reference point determination with laser tracker and a new mathematical model done by Michael Lösler (Uni Karlsruhe)
- Cleaning and fixing of the antenna tower and panel framework
- Operating the SELENE hardware
- Regular tasks and maintenance days (obtaining replacements for the hardware, 8-pack repair, gear maintenance, Field System updates)
- Planning of the new TWIN radiotelescope Wettzell:
  - final project design and design review with finalization of the construction
  - design of the operation building
  - construction of an additional gravimetry building as a replacement during the TWIN construction phase
  - ideas for the realization of the VLBI2010 broadband suggestions

## 5. Plans for 2009

During 2009, dedicated plans are:

- Integration of the digital baseband converters (DBBC)
- Extension of the software developments for remote control and Field System extension
- Construction phase for the towers of the VLBI2010 TWIN-telescope.

## Instituto Geográfico Nacional of Spain

*Francisco Colomer, Pablo de Vicente, Jesús Gómez–González,  
José Antonio López–Fernández, Susana García Espada*

### Abstract

This report updates the description of the OAN facilities as an IVS network station. The new 40-m radiotelescope performed the first geodetic VLBI observations in September 2008. While commissioning for other frequencies is in progress, the instrument will participate regularly in IVS campaigns in 2009.

### 1. General Information: the IGN Facilities at OAN-Yebes

The Observatorio Astronómico Nacional (OAN) of Spain is a department of the Instituto Geográfico Nacional (IGN, Ministerio de Fomento) and operates a new 40-m radiotelescope at Yebes (Guadalajara, Spain). The facility also includes an old 14-m radiotelescope, which was a network station of the IVS and participated regularly in the geodetic VLBI campaigns until 2003. It is being refurbished to become a tracking station for the next space radiotelescope VSOP-2.

Yebes is also the reference station for the Spanish GPS network. A building has been finished to hold the IGN gravimeters.

### 2. IGN-OAN Staff Working on VLBI Projects

Table 1 lists the OAN staff who are involved in geodetic VLBI studies and operations. The VLBI activities are also supported by other staff such as receiver engineers, computer managers, secretaries, and students. The hiring of dedicated telescope operators is in progress.

Table 1. Staff in the OAN VLBI group (Email: [vlbitech@oan.es](mailto:vlbitech@oan.es)).

Name	Background	Role	Address*
Francisco Colomer	Astronomer	VLBI Project coordinator	OAM
Susana García-Espada	Engineer	Ph.D. student	CAY
Jesús Gómez–González	Astronomer	Deputy Director for Astronomy, Geodesy and Geophysics	IGN
José Antonio López–Fdez	Engineer	CAY site manager	CAY
Pablo de Vicente	Astronomer	VLBI Technical coordinator	CAY

#### Addresses:

**OAM:** Observatorio Astronómico de Madrid. Calle Alfonso XII, 3. E–28014 Madrid. Spain.

**CAY:** Centro Astronómico de Yebes. Apartado 148, E–19080 Guadalajara. Spain.

**IGN:** Instituto Geográfico Nacional. Calle General Ibañez de Ibero 3, E–28003 Madrid. Spain.

Table 2. Characteristics of the Yebes 40-m geodetic VLBI station.

Parameter	Value	DAR	VLBA4 (14) + VSI-C
Diameter	40 meter	Recorder	Mark 5B
Receivers	2 - 115 GHz	H-maser	KVARTZ CH-1
S/X $T_{\text{sys}}$	180/60 K	GPS	TrueTime XL-DC
S/X SEFD	800/200 Jy	Weather station	SEAC-EMC

### 3. Status of the Geodetic VLBI Activities at OAN

The most important milestone has been the participation of the new 40-m radiotelescope in geodetic VLBI campaigns. After a first successful test at S/X bands on September 12 (R4343), regular observations started with experiment R1349 (October 20).

The cooperation with the geodesy group at Onsala Space Observatory in Sweden continued during 2008. The analysis of VLBI sessions and GPS time series was performed for the 14-m radiotelescope at the Yebes site from 1995 to 2003 (see Figure 1). For VLBI sessions, the best available a priori geophysical models and auxiliary weather information from European Center for Medium-Range Weather Forecast (ECMWF) were used. The results derived from VLBI measurements are consistent with the plate tectonic motion and no significant movements are detected. The GPS results may detect a deviation in the horizontal components, which is not supported by the VLBI results. A small relative motion between the VLBI and the GPS monuments seems to be detected (see Fig. 2).

We also started to study the HIRLAM 3D-VAR numerical weather prediction model in order to calculate a direct improved mapping function using raytracing for modelling the tropospheric effect caused by neutral atmosphere.

### 4. Future Plans

The connection of Yebes to GÉANT at 1 Gbps, thanks to the EC project EXPReS, is expected to be operational in February 2009. The construction of a network of concrete pillars around the 40-m radiotelescope to measure the reference point of the instrument and the local tie to the old 14-m radiotelescope is delayed.

### References

- [1] López-Fernández J.A., Serna-Puente J.M., Tercero F., Yagüe J.M., Abad J.A., Almendros C., Henche S., Fernández J. “Criostato de los receptores X/Ku de la antena ARIES XXI del CAY”. Informe Técnico OAN 2008-4 (see <http://www1.oan.es/informes/archivos/IT-OAN-2008-4.pdf>).
- [2] García-Espada S., Haas R., Colomer F. “Space Geodesy at Yebes: Station Motion from VLBI and GPS”. 2008. In: Proceedings of the 5<sup>th</sup> IVS General Meeting “Measuring the future”, eds A. Finkelstein, D. Behrend. s. 93-97. ISBN/ISSN: 978-5-02-025332-2 Nr. 79323.

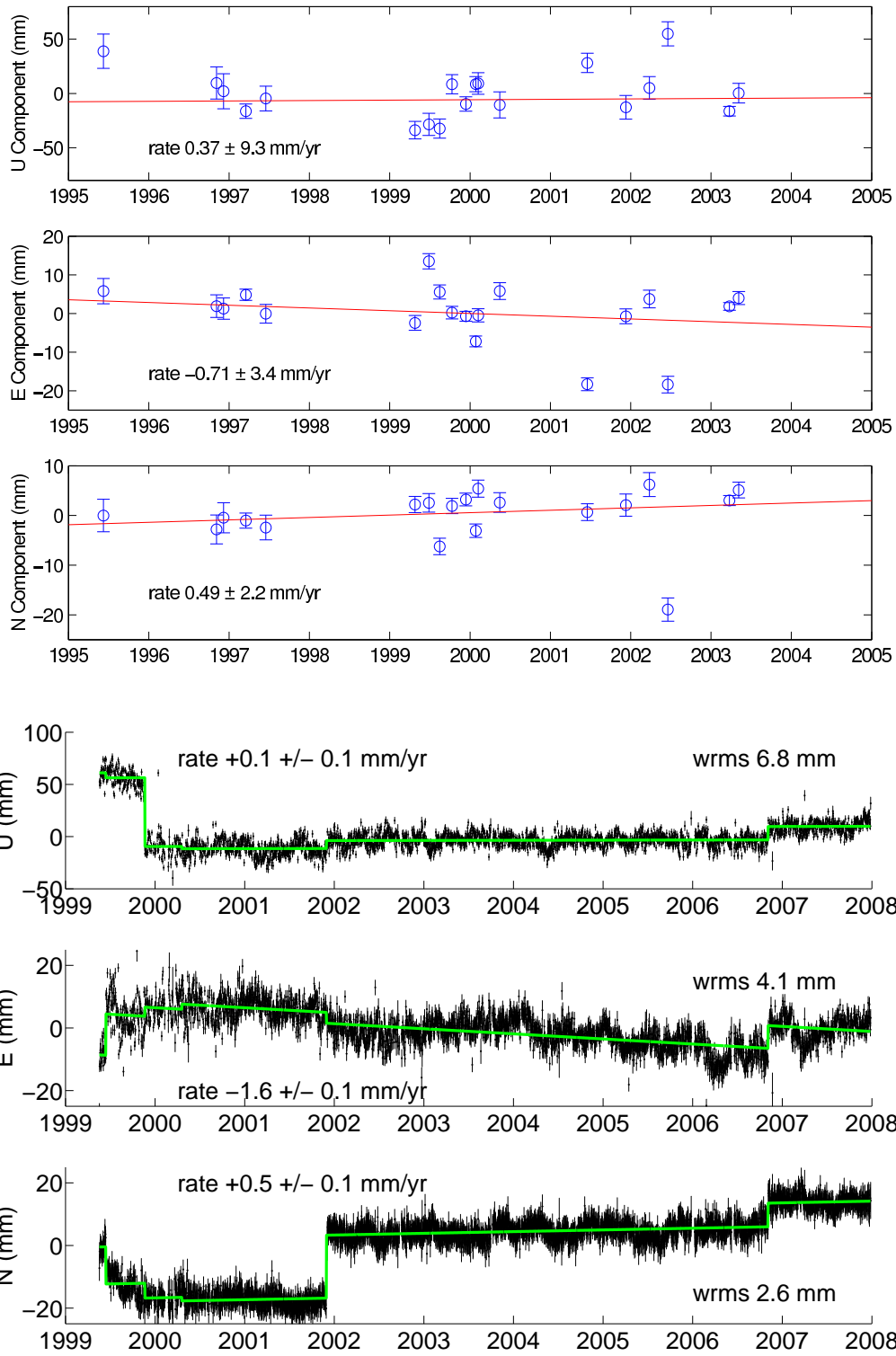

Figure 1. Time series of topocentric station positions for the Yebes VLBI (top) and GPS station (bottom). Plate motion according to Nuvel-1 has been subtracted. From García-Espada et al. (2008)

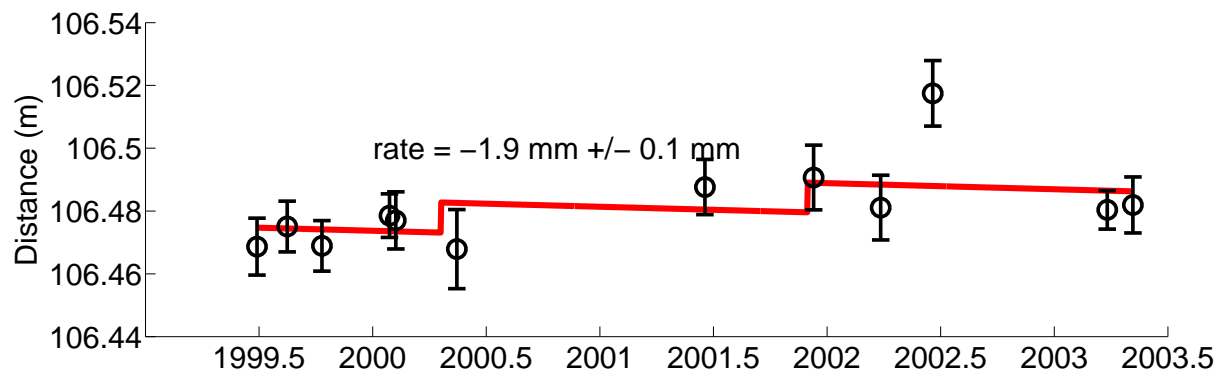

Figure 2. Time series of the distance between the VLBI and GPS monuments at Yebes. From García-Espada et al. (2008)

# Zelenchukskaya Radio Astronomical Observatory

*Andrei Dyakov, Sergey Smolentsev*

## Abstract

This report briefly summarizes the observational activities at the Zelenchukskaya 32-m VLBI station during the year 2008.

## 1. General Information

Zelenchukskaya Radio Astronomical Observatory was founded by Institute of Applied Astronomy (IAA) as one of three stations of the Russian VLBI network QUASAR. The sponsoring organization of the project is the Russian Academy of Sciences (RAS). The Zelenchukskaya Radio Astronomical Observatory is situated in Republic Karachaevo-Cherkessiya (Northern Caucasia) about 70 km south of Cherkessk, near to the Zelenchukskaya site (not far from Radiotelescope RATAN-600). The geographic location of the observatory is shown on the IAA RAS Web site: [http://www.ipa.nw.ru/PAGE/koi8-r/DEPOBSERV/rus\\_zel.htm](http://www.ipa.nw.ru/PAGE/koi8-r/DEPOBSERV/rus_zel.htm). The basic instruments of the observatory are a 32-m radio telescope and technical systems for doing VLBI observations.



Figure 1. Zelenchukskaya Observatory.

Table 1. Zelenchukskaya Observatory location and address.

Longitude	41°34'
Latitude	43°47'
Zelenchukskaya Observatory	
Republic Karachaevo-Cherkessia	
369140, Russia	
ipazel@mail.svkchr.ru	

## 2. Technical and Scientific Information

The technical parameters of the radiotelescope RT-32 and Zelenchukskaya station equipment are presented in Table 2.

The data acquisition system VLBA-4 was equipped with recording terminals Mark 5B (instead of S2) and RDR-1 (RADIOASTRON). The RDR-1 terminal will be used in 2009 for observations within the RADIOASTRON space mission.

### 2.1. Co-location GPS and Laser Range System (LRS)

The permanent GPS receiver ASHTECH Z-X113 with an ASH 700936D\_M antenna Dorne-Margolin/Choke Ring was installed at the observatory in 2006. Observed data are sent to BKG and IGS every hour.

Table 2. Technical parameters of the radio telescope.

Year of construction	2000
Mount	AZEL
Azimuth range	$\pm 270^\circ$ (from south)
Elevation range	from $-5^\circ$ to $95^\circ$
Maximum azimuth	
- velocity	$1.5^\circ/\text{s}$
- tracking velocity	$1.5'/\text{s}$
- acceleration	$0.2^\circ/\text{s}^2$
Maximum elevation	
- velocity	$0.8^\circ/\text{s}$
- tracking velocity	$1.0'/\text{s}$
- acceleration	$0.2^\circ/\text{s}^2$
Pointing accuracy	better than $10''$
Configuration	Cassegrain (with asymmetrical subreflector)
Main reflector diameter	32 m
Subreflector diameter	4 m
Focal length	11.4 m
Main reflector shape	quasi-paraboloid
Subreflector shape	quasi-hyperboloid
Surface tolerance of main reflector	$\pm 0.5$ mm
Frequency capability	1.4–22 GHz
Axis offset	$-11.5 \pm 0.5$ mm

## 3. Participation in the IVS Observing Program

Table 3 summarizes the sessions performed during 2008. During 2008 Zelenchukskaya IVS station participated in 72 IVS-R1, IVS-R4, EUROPE, CONT08, and VLBA sessions.

Table 3. List of IVS sessions observed at ZcRAO in 2008.

Month	IVS-R1	IVS-R4	CONT08	EURO	VLBA
January		2			1
February	1	4			
March	2	3			
April	3	3			1
May		3		1	1
June	3	2			
July	2	4			1
August		1	15		
September	5			1	1
October	3	3			
November	1				
December	3	1			1
Total	23	26	15	2	6

#### 4. Outlook

Our plans for the coming year are the following:

- Participation in IVS-R1, IVS-R4, IVS-T2, EUROPE, VLBA, and domestic observing sessions.
- Upgrade of electronic part of the hydrogen maser CH1-80.
- Determine local tie through geodetic measurements of the Radio Telescope (including the axis offset determination).





Operation Centers

Operation Centers



# The Bonn Geodetic VLBI Operation Center

*A. Nothnagel, A. Müskens*

## Abstract

The IGGB Operation Center has continued to organise and schedule the IVS-T2, IVS-OHIG, IVS-INT3, and EUROPE sessions.

## 1. Center Activities

The IGGB VLBI Operation Center is located at the Institute of Geodesy and Geoinformation of the University of Bonn, Nussallee 17, D-53115 Bonn, Germany. It has been organizing and scheduling VLBI observing sessions for more than twenty years. The observing series organized and scheduled in 2008 are the same as in 2007.

- **Measurement of Vertical Crustal Motion in Europe by VLBI (EUROPE)**

In Europe, a series of special sessions has been scheduled for the determination of precise station coordinates and for long term stability tests. This year, six sessions with Ny-Ålesund, Onsala, Metsahovi, Svetloe, Zelenchukskaya, Badary, Effelsberg, Wettzell, Simeiz, Madrid (DSS65A), Medicina, Matera, and Noto were scheduled employing the frequency setup of 16 channels and 4 MHz bandwidth in fan-out mode (identical to the setup of the IVS-T2 sessions).

- **IVS-T2 Series**

This series has been observed roughly every second month (7 sessions in 2008) primarily for maintenance and stabilization of the VLBI terrestrial reference frame as well as for Earth rotation monitoring as a by-product. Each station of the global geodetic VLBI network is planned to participate at least once per year in the T2 sessions. In view of the limitations in station days, priority was given to stronger and more robust networks with many sites over more observing sessions. Therefore, 12 to 15 stations have been scheduled in each session, requiring multiple passes through the IVS correlators. The scheduling of these sessions has to make sure that a sufficient number of observations is planned for each baseline of these global networks. The recording frequency setup is 16 channels and 4 MHz channel bandwidth.

- **Southern Hemisphere and Antarctica Series (OHIG):**

Seven sessions of the Southern Hemisphere and Antarctica Series with the Antarctic stations Syowa (Japanese) and O'Higgins (German) plus Fortaleza, Hobart, Kokee, HartRAO and DSS45 have been organized for maintenance of the VLBI TRF and Earth rotation monitoring. These sessions are clustered in time at periods when O'Higgins is manned, depending on logistical circumstances and available manpower. The recording frequency setup is 16 channels and 4 MHz channel bandwidth. Due to the fact that Syowa is not able to deliver the recorded data for several months after the observations, the correlation and the generation of the databases will be delayed considerably.

- **UT1 Determination with Near-real-time e-VLBI (INT3):**

The so-called INT3 sessions included the telescopes of Ny-Ålesund, Tsukuba and Wettzell for weekly UT1 determinations with rapid processing time. Since August 2007 these sessions have been scheduled to start every Monday morning at 7:00 a.m. UT.

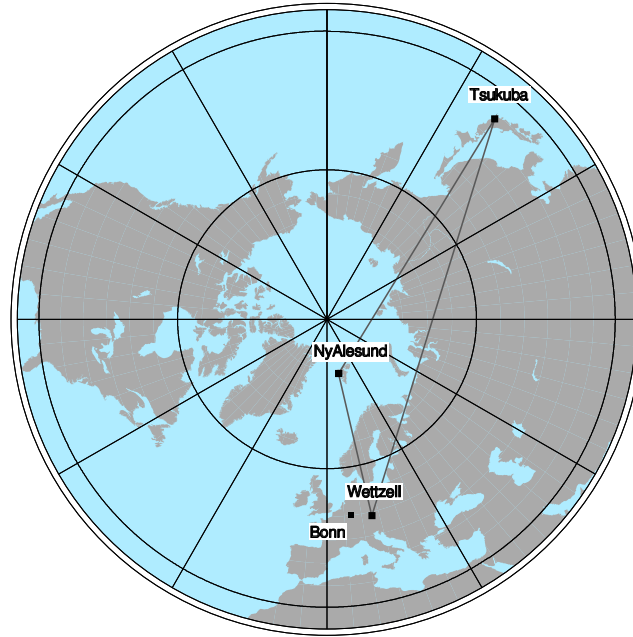

Figure 1. INT3 Network

In order to speed up delivery of the results, the raw VLBI observation data of the three sites is transferred to the Bonn Correlator by Internet connections. The transmission rate is about 100 Mb/s for Ny-Ålesund (limited due to the use of a radio link for the first part of the distance) and 400 Mb/s from Tsukuba and Wettzell. For compatibility reasons, the data of Tsukuba, initially recorded in K4 format, has to be copied to Mark 5 format after transmission. 16 channels with 8 MHz/channel are recorded resulting in 256 MBit/s. With close to 30 minutes effective observing and recording time, each station has to transfer about 460 GBit or 58 GBytes per session. Due to copying procedures and current network capacities, the threshold for completion of delivery of the raw VLBI data to the correlator is currently about seven hours after the final observation. In 2008, 42 sessions were observed and transmitted successfully. Correlation and database delivery were completed for 75% of the sessions within the first 8 hours after the end of the observations. A further 15% were completed within 10 hours. The rest took between 10 and 24 hours due to difficulties with networking hardware.

## 2. Staff

Table 1. Personnel at IGGB Operation Center

Arno Mueskens	+49-228-525264	mueskens@mpifr-bonn.mpg.de
Axel Nothnagel	+49-228-733574	nothnagel@uni-bonn.de

# CORE Operation Center Report

*Cynthia C. Thomas, Daniel MacMillan*

## Abstract

This report gives a synopsis of the activities of the CORE Operation Center from January 2008 to December 2008. The report forecasts activities planned for 2009.

## 1. Changes to the CORE Operation Center's Program

The Earth orientation parameterization goal of the IVS program is to attain precision at least as good as  $3.5 \mu\text{s}$  for UT1 and  $100 \mu\text{as}$  in pole position.

The IVS program, which started in 2002, initially used the Mark IV recording mode for each session. The IVS program began using the Mark 5 recording mode in mid-2003. By the end of 2007, all stations were upgraded to Mark 5. Due to the efficient Mark 5 correlator, the program continues to be dependent on station time and media—as it has been for the past four years. The following are the network configurations for the sessions for which the CORE Operation Center was responsible:

IVS-R1: 52 sessions, scheduled weekly and mainly on Mondays, six to eight station networks

RDV: 6 sessions, scheduled evenly throughout the year, 14 to 18 station networks

IVS-R&D: 10 sessions, scheduled monthly, five to seven station networks

## 2. IVS Sessions from January 2008 to December 2008

This section displays the purpose of the IVS sessions for which the CORE Operations Center is responsible.

- IVS-R1: In 2008, the IVS-R1s were scheduled weekly with six to eight station networks. There were four stations that participated in at least half of the scheduled sessions, Ny-Ålesund, Westford, Fortaleza, and Wettzell. Both Ny-Ålesund and Zelenchukskaya were tagged along to all IVS-R1 sessions in which the two stations participated.

The purpose of the IVS-R1 sessions is to provide weekly EOP results on a timely basis. These sessions provide continuity with the previous CORE series. The “R” stands for “rapid turnaround” because the stations, correlators, and analysts have a commitment to make the the time delay from the end of recording to the results as short as possible. The time delay goal is a maximum of 15 days. Participating stations are requested to ship discs to the correlator as rapidly as possible. The “1” indicates that the sessions are mainly on Mondays.

- RDV: There are six bi-monthly coordinated astrometric/geodetic experiments each year that use the full 10-station VLBA plus up to 8 geodetic stations.

These sessions are being coordinated by the geodetic VLBI programs of three agencies: 1. USNO will perform repeated imaging and correction for source structure; 2. NASA will analyze this data to determine a high accuracy terrestrial reference frame; and 3. NRAO will use these sessions to provide a service to users who require high quality positions for a

small number of sources. NASA (the CORE Operation Center) prepares the schedules for the RDV sessions.

- R&D: The purposes of the nine R&D sessions in 2008, as decided by the IVS Observing Program Committee, were the following. The purpose of sessions one, five, and six was to observe high-redshift radio sources. The purpose of sessions two through four was to test the 512 Mbps recording mode for possible usage in the CONT08 campaign. Sessions seven and eight were used to vet candidate geodetic sources. Session nine was used to select sources for the next generation of the ICRF, which will be unveiled in 2009.
- CONT08: The purpose of CONT08 was to provide a two-week campaign of continuous VLBI sessions, scheduled for observing during the month of August (August 12 through August 27). The CONT08 campaign continues the series of the very successful continuous VLBI campaigns that were observed at irregular intervals: January 1994, August 1995, September 1996, October 2002, and September 2005.

### 3. Current Analysis of the CORE Operation Center's IVS Sessions

Table 1 gives the average formal errors for the R1, R4, RDV, and T2 sessions from 2008. The R1 sessions have formal uncertainties about the same as for 2006, but worse than in 2007. It is not clear what is different for the 2008 R1 sessions, but it is possible that network differences account for the change in formal uncertainties. R4 uncertainties for 2008 are at about the same level as for 2006—2007. RDV uncertainties are better in 2008 than 2007. This may be due in part to an increase in the number of sites in the RDV sessions from 15-16 sites in 2007 to 17-18 sites in 2008.

Table 2 shows the EOP differences with respect to IGS for the R1, R4, T2, and RDV series. For most session types, the level of WRMS agreement in 2008 is better than the WRMS agreement for all sessions of that type. The WRMS differences were computed after removing a bias, but estimating rates does not affect the residual WRMS significantly.

Table 1. Average EOP formal uncertainties for 2008.

Session Type	Num	X-pole ( $\mu$ as)	Y-pole ( $\mu$ as)	UT1 ( $\mu$ s)	DPSI ( $\mu$ as)	DEPS ( $\mu$ as)
R1	50	56(45,54)	51(43,52)	2.4(1.9,2.5)	109(82,111)	42(33,45)
R4	50	72(69,73)	79(73,72)	2.8(2.9,3.2)	176(162,166)	73(68,67)
T2	5	53(44,54)	66(49,55)	2.7(2.2,2.5)	127(107,126)	55(36,48)
RDV	5	43(50,40)	45(53,41)	2.2(2.8,1.9)	77(92,74)	30(41,31)

Values in parentheses are for 2007 and then 2006

### 4. The CORE Operations Staff

Table 3 lists the key technical personnel and their responsibilities so that everyone reading this report will know whom to contact about their particular question.

Table 2. Offset and WRMS differences (2008) relative to the IGS Combined Series.

Session Type	Num	X-pole		Y-pole		LOD	
		Offset ( $\mu$ as)	WRMS ( $\mu$ as)	Offset ( $\mu$ as)	WRMS ( $\mu$ as)	Offset ( $\mu$ s/d)	WRMS ( $\mu$ s/d)
R1	52(356)	-29(8)	92(90)	64(49)	71(89)	-3(-2)	17(17)
R4	52(355)	-44(-35)	101(108)	56(45)	108(109)	-5(0)	15(19)
RDV	5(53)	-13(65)	71(85)	47(73)	87(89)	-3(0)	14(15)
T2	5(57)	-33(3)	63(139)	3(11)	93(125)	15(-2)	11(19)

Values in parentheses are for the entire series for each session type

Table 3. Key technical staff of the CORE Operations Center.

Name	Responsibility	Agency
Dirk Behrend	Organization of CORE program	NVI, Inc./GSFC
Brian Corey	Analysis	Haystack
Irv Diegel	Maser maintenance	Honeywell
Mark Evangelista	Receiver maintenance	Honeywell
John Gipson	SKED program support and development	NVI, Inc./GSFC
Frank Gomez	Software engineering for the Web site	Raytheon/GSFC
David Gordon	Analysis	NVI, Inc./GSFC
Ed Himwich	Network Coordinator	NVI, Inc./GSFC
Dan MacMillan	Analysis	NVI, Inc./GSFC
David Rubincam	Procurement of materials necessary for CORE operations	GSFC/NASA
Braulio Sanchez	Procurement of materials necessary for CORE operations	GSFC/NASA
Dan Smythe	Tape recorder maintenance	Haystack
Cynthia Thomas	Coordination of master observing schedule and preparation of observing schedules	NVI, Inc./GSFC

## 5. Planned Activities during 2009

The CORE Operation Center will continue to be responsible for the following IVS sessions during 2009.

- The IVS-R1 sessions will be observed weekly and recorded in a Mark 5 mode.
- The IVS-R&D sessions will be observed ten times during the year.
- The RDV sessions will be observed six times during the year.

# NEOS Operation Center

*Kerry Kingham, M.S. Carter*

## Abstract

This report covers the activities of the NEOS Operation Center at USNO for 2008. The Operation Center schedules IVS-R4 and the INT1 Intensive experiments.

## 1. VLBI Operations

NEOS operations in the period covered consisted, each week, of one 24-hour duration IVS-R4 observing session, on Thursday-Friday, for Earth Orientation, together with five daily one-hour duration “intensives” for UT1 determination, Monday through Friday. The operational IVS-R4 network has included VLBI stations at Kokee Park (Hawaii), Wettzell (Germany), Fortaleza (Brazil), Ny-Ålesund (Norway), TIGO (Chile), Svetloe, Badary and Zelenchukskaya (Russia), Hobart (Australia), Matera and Medicina (Italy), and Westford (USA). A typical R4 consisted of 6 to 8 stations.

The regular stations for the weekday IVS Intensives were Kokee Park and Wettzell. Intensives including Kokee Park, Wettzell, and Svetloe were observed twice per month in order to characterize the Kokee Park – Svetloe baseline so that Svetloe can be used as an alternate for Wettzell should it be needed.

The Operations Center migrated from the older Unix version of the “sked” program to the Linux version. Starting 15 September, all R4 and Intensive schedules were written using the Linux version of sked.

All sessions are correlated at the Washington Correlator, which is located at USNO and is run by NEOS.

Table 1. Experiments scheduled during 2008

52	IVS-R4 experiments
212	Intensives (Kk–Wz)
24	Kk-Sv-Wz Intensives

## 2. Staff

K. A. Kingham and M. S. Carter are the only staff members of the NEOS Operation Center. Kingham is responsible for the overall management, and Carter makes the schedules. M. S. Carter is located at the USNO Flagstaff Station (NOFS).





Correlators

Correlators



# The Bonn Astro/Geo Mark IV Correlator

*Simone Bernhart, Alessandra Bertarini, Arno Müskens, Walter Alef*

## Abstract

The Bonn Mark IV VLBI correlator is operated jointly by the MPIfR and the IGG in Bonn and the BKG in Frankfurt. Since 2007, e-VLBI transfers have become routine for geodetic experiments, and, thanks to that, a new Intensive series (INT3) was introduced and is correlated in Bonn. Three Mark 5B units have been installed and are in regular use for stream correlation. In late December 2007, the first phase of a Linux cluster dedicated for the software correlator, which will become the long-term future replacement of the hardware correlator, was installed. Towards the end of 2008 the cluster was extended to 60 nodes with nearly 500 compute-cores and 40 TB of disk storage.

## 1. Introduction

The Bonn Mark IV correlator is hosted at the Max-Planck-Institut für Radioastronomie (MPIfR)<sup>1</sup> Bonn, Germany. It is operated jointly by the MPIfR and the Bundesamt für Kartographie und Geodäsie (BKG)<sup>2</sup> in cooperation with the Institut für Geodäsie und Geoinformation der Universität Bonn (IGG)<sup>3</sup>. It is a major correlator for geodetic observations and MPIfR's astronomical projects, for instance those involving millimeter wavelengths and astrometry.

## 2. Present Status and Capabilities

The Bonn correlator is one of the four Mark IV VLBI data processors in the world. It has been operational since 2000. It consists of a standard Mark IV correlator rack, eight Mark 5A systems and three Mark 5B systems, and one additional unit dedicated to e-VLBI, which can also be used as a Mark 5B unit. Two Mark 5B+ units for testing purposes and another two Mark 5C units, yet without C boards, are available in the labs. A summary of the Bonn correlator capabilities is in Table 1. A Linux file server stores all files related to the correlation of the data. The correlator is controlled by a dedicated Linux workstation and an HP workstation, both connected to the Linux file server. Correlation setup, data inspection, fringe-fitting, and data export are done on a second Linux machine connected to the Linux file server. Data security is guaranteed by using a file system with redundancy (RAID level 5) and by daily back-up of the data on a PC disk.

## 3. Staff

The people in the geodetic group at the Bonn correlator are

**Arno Müskens** - group leader, scheduling of T2, OHIG, EURO, INT3, and e-VLBI supervisor.

**Simone Bernhart** - experiment setup and evaluation of correlated data, media shipping, e-VLBI operations.

**Alessandra Bertarini** - experiment setup and evaluation of correlated data, software correlator development, e-VLBI commissioning tests, and media shipping. Digital baseband converter (DBBC) testing. Ph.D. student at IGGB since early 2007, subject of the thesis: Effects on the

---

<sup>1</sup><http://www.mpifr-bonn.mpg.de/div/vlbicor/>

<sup>2</sup><http://www.bkg.bund.de/>

<sup>3</sup><http://igg.geod.uni-bonn.de/>

geodetic-VLBI measurables due to polarization leakage in the receivers.

**Laura La Porta** - (since Nov. 2008) experiment setup and evaluation of correlated data.

**Stefan Klein** - e-VLBI operations (successor of Christian Dulfer).

**Bertalan Feher** - setup and trial correlation of INT3.

**Frédéric Jaron** - e-VLBI support, software support, and Web page maintenance.

**Four student operators** for the night shifts and the weekends.

Table 1. Correlator Capabilities

#### PLAYBACK UNITS

Number available: 8 Mark 5A systems, 4 Mark 5B systems

Playback speeds: real-time up to 1024 Mb/s  
(2024 Mb/s slowed down by a factor of 2)

#### SUPPORTED RECORDING

Record data rates: any rates supported by Mark 5

Formats: Mark III/Mark IV/VLBA (Mark IV/VLBA w/wo barrel roll, data demod.)

Sampling: 1 or 2-bit (over-sampling not yet tested)

Fan-out: 1:1 1:2 1:4 (fan-in not supported)

No. of channels:  $\leq 16$ , USB and/or LSB  
(multiple passes supported for  $>16$  channels in MK4IN)

Bandwidth/channel: 2, 4, 8, 16 MHz

Signals: mono, dual frequency or dual polarization

Modes: Mark III: B, C, BB, CC; A, AA (in 2 passes)

128-16-1 128-16-2 128-8-1 128-8-2 128-4-1 128-4-2

128-2-2 256-16-1 256-16-2 256-8-1 256-8-2 256-4-2

512-16-2 512-8-2 1024-16-2 2048 Mb/s with Mark 5B+

#### CORRELATION

Geometric model: CALC 8

Number of boards: 16 (DSP not yet implemented)

Phase cal: dual tone extraction at selectable freqs (single-tone analysed)

Pre-average times: 0.2  $\rightarrow$  5 s (default 2 s; 60/N s, N an integer; short  
integration times not with full correlator capacity)

Lags per channel: 32 min. ( $\Rightarrow$  frequency resolution = BW/16), 1024 max.

Maximum output: 8 stations: 28 baselines, 16 channels, 32 lags with ACF and  
full cross polarization (higher output possible, but untested)  
10 stations tested with single polarization and ACF  
(requires mixture of Mark 5A and 5B)

Multiple streams: Maximum of 4 independent correlations for  
simultaneous correlation of sub-nets, etc.

Multiple passes: Supported for  $>8$  stations (up to 16 in 6 passes or less)

Fringe-fit: Off-line FOURFIT run. (Dual frequency in single  
execution: dual/cross-polsn. in multiple executions)

Export: Database, MK4IN to AIPS

The people in the astronomy group of MPIfR at the Bonn correlator who support IVS correlation are

**Walter Alef** - head of the VLBI technical department, correlator software maintenance and upgrades, computer system administration, and friend of the correlator.

**David Graham** - technical development, consultant, software correlator development, and DBBC development and testing.

**Alan Roy** - deputy group leader, water vapour radiometer (WVR), technical assistance, and development of FPGA firmware for linear to circular polarization conversion.

**Heinz Fuchs** - correlator operator, responsible for the correlator operator schedule, daily operations, and media shipping.

**Hermann Sturm** - correlator operator, correlator support software, media shipping, and Web page development.

**Michael Wunderlich** - engineer maintaining correlator, Mark 5, and development of the DBBC.

**Rolf Märten** - technician maintaining correlator hardware and Mark 5 playbacks.

**Marcus Offermanns** - DBBC production, fixed-term contract for one year with INAF, Italy.

**Gino Tuccari** - guest scientist from INAF, DBBC development, DBBC project leader.



Figure 1. Left picture: sound and thermal insulation room for the software correlator still under construction, right panel: temporary correlator room with one Mark 5A rack (center - side view) standing in-room without cooling.

#### 4. Status

**Experiment Status:** In 2008 the Bonn group correlated 45 R1, five EURO, two T2, 10 OHIG, 42 INT3, and about 30 astronomical experiments.

**e-VLBI:** Near-real-time e-VLBI transfers from Tsukuba, Ny-Ålesund, Onsala, Metsähovi, Wettzell, and Kashima have become regular at the correlator. Data from the Japanese Antarctic station Syowa, which frequently takes part in OHIG experiments, and data from Japanese stations Aira and Chichijima have successfully been transferred to Bonn (from Kashima) for the first time in 2008. e-VLBI transfer reduces the time between observation and correlation since no shipment is

required. The data rates achieved a range from 100 Mb/s with Ny-Ålesund (limited by radio link) to 400 Mb/s with peaks up to 800 Mb/s. The transfers are done using the UDP-based Tsunami protocol. The total disk space available for e-VLBI data storage at the correlator is currently about 20 Tbytes. In addition to the standard geodetic experiments, we correlated two 8.3 GHz (X-Band) experiments within the framework of the Long Baseline Array (LBA) Calibrator Survey (LCS). Three of the four LBA stations that took part in the experiment were electronically transferred to the correlator.

**INT3:** The third Intensive series (INT3), which was introduced in late summer 2007, is scheduled and correlated at Bonn every Monday. Thanks to near-real-time e-VLBI transfer, the turnaround between observation and database submission to the analysis center is about seven hours.

**Correlator Status:** The last tape drive was finally decommissioned, and no further experiments recorded on tapes can be correlated at Bonn. There are currently three Mark 5A units equipped with software development kit (SDK) 7.12.99. This SDK version allows the reading of Serial-ATA (SATA) Mark 5 modules. The first successful test using SATA modules was performed in October 2008. The SATA modules are used for the correlation of e-VLBI transferred data.

**Software Correlator:** In 2008, one astronomical multi-field (10 fields and 96 sources) VLBI experiment has been correlated and analyzed successfully. Furthermore, two geodetic INT3 experiments have been correlated but not yet analyzed. In order to meet the requirements of the software correlator, especially concerning cooling and noise reduction, the correlator room is being reconstructed since November 2008 (see Fig. 1).

**DBBC:** The Bonn group is involved in the DBBC development for the European VLBI Network (EVN). This unit is designed as a full replacement for the existing analog BBCs. The design of version 2 of the Analog-to-Digital Converter board (ADC2) was finished in 2008. A 2 x 10 Gbit Ethernet interface card is under development.

## 5. Outlook for 2009

**Correlator:** There will be a gradual changeover to Mark 5B, which will further simplify the correlation process since the station units will no longer be needed.

**Software Correlator:** The reconstruction work on the software correlator is expected to be finished by the beginning of February 2009. The changeover to the software correlator is expected for late 2009 or early 2010.

**e-VLBI:** Stream correlation using e-VLBI transfer will continue, and e-VLBI tests with other antennas are envisaged. Three stations that took part in a third experiment within the framework of the LCS project (observed in November 2008) will be electronically transferred to Bonn for correlation.

**Personnel Changes:** John Morgan, a Ph.D. student from Bologna, will be visiting the MPIfR until the end of April. One of his tasks might be the implementation of the phase calibration tones extraction into the software correlator. From March on, another MPIfR employee, Helge Rottmann, will dedicate 50% of his time to the development of the software correlator.

**DBBC:** The production is soon to start, and the completion of the design of two prototype 10 Gbit boards is expected within the first quarter of 2009.

## Haystack Observatory VLBI Correlator

*Mike Titus, Roger Cappallo, Brian Corey, Kevin Dudevoir, Arthur Niell, Alan Whitney*

### Abstract

This report summarizes the activities of the Haystack Correlator during 2008. Highlights include correlation of many broadband delay (VLBI2010) experiments and installation at WACO of the correlator run-time software that had been converted to Linux. Problems with bad disks and serial links were investigated. Real-time e-VLBI development for Mark 5B, non-real-time e-VLBI transfers, and engineering support of other correlators continued.



Figure 1. Partial view of the Haystack Mark IV correlator, showing five racks containing (left to right) four Mark 5A correlator playback units, the Mark IV correlator, three Mark 5A correlator playback units, and one Mark 5B correlator playback unit (bottom) with the associated correlator interface board unit, two Mark 5B correlator playback units with associated correlator interface board units, and three station units.

### 1. Introduction

The Mark IV VLBI correlator of the MIT Haystack Observatory, located in Westford, Massachusetts, is supported by the NASA Space Geodesy Program and by the National Science Foundation. The available correlator time is dedicated mainly to the pursuits of the IVS, with a small portion of time allocated to processing radio astronomy observations for the Ultra High Sensitivity VLBI (u-VLBI) project. The Haystack Correlator serves as a development system for testing new correlation modes, for e-VLBI, for hardware improvements such as the Mark 5C system, and for diagnosing correlator problems encountered at Haystack or at one of the identical correlators at the U.S. Naval Observatory and the Max Planck Institute for Radioastronomy. This flexibility is made possible by the presence on-site of the team that designed the correlator hardware and software. Additionally, some production correlator time is dedicated to processing geodetic VLBI observations for the IVS.

## 2. Summary of Activities

### 2.1. Broadband Delay Experiments

Several broadband delay development experiments using prototype VLBI2010 systems were conducted and correlated in a wide variety of configurations, including different frequency placements of the RF bands, different LO frequency offsets, and phase cal modifications of various types. These experiments were designed to explore the capabilities, and potential limitations, of the evolving VLBI2010 hardware. Most were interferometric observations between the Westford 18-m and the GGAO 5-m antennas, with the post-receiver hardware at each site including two digital back ends (DBEs) and four Mark 5B+ units. Many astronomical observations conducted by the u-VLBI program using DBEs and Mark 5B+ units were processed as well.

### 2.2. WACO Linux Correlator Run-time Software Conversion and IP Change

The Linux correlator run-time software conversion which was implemented at the Haystack and Bonn correlators in 2007 was carried out at WACO in early 2008. Later in the year a project to change all the IP addresses of networked devices on the WACO correlator was completed. This was needed in order to address security requirements for the Navy. This was a major project and involved setting up an independent network at Haystack in order to test the changes in advance.

### 2.3. Mark 5A/5B/5C Recording System Related Projects

Problems related to the handling of bad disks with Conduant SDK 7 software have been resolved with a special version of John Ball's Mark 5A code and SDK 8.1. A new release of the software specifically for the correlators is in beta testing. A Mark 5C record mode test was conducted to evaluate the ability of a Mark 5C system to record at 4 Gb/sec in Mark 5B mode. For information regarding the Mark 5C recording system, please refer to the "Haystack Observatory Technology Development Center" report. SATA disk testing was conducted so that newly purchased SATA disks could be used in the August CONT session. Those investigations and other Mark 5 related system testing continue.

### 2.4. Input Board Serial Link Tests

An extensive investigation into data corruption issues associated with new style serial links installed in correlator input boards was conducted this year. These new links were designed and built by the Bonn group at MPI in order to provide replacements (and expansion stock) for the original serial links, which contained obsolete parts. A problem with these links manifested itself in the course of expanding the number of playback units on the Mark IV correlator. The symptom was intermittent data corruption in single channels. The problem was found to be an incorrect component installed on the boards. The boards were subsequently modified and the problem solved. This issue was important to resolve, as it was preventing the expansion of the correlator with more Mark 5B data output modules (DOMs).



## 2.5. e-VLBI

Development of real time software for Mark 5B continued. A version of the code was exported to JIVE this year. Non-real-time transfers have continued. Data from 30 experiments were transferred to Haystack this year from five stations, all in Japan: Kashima, Tsukuba, Chichijima, Shintotsukawa, and Aira.

## 2.6. Other Projects

General support of the other Mark IV correlators continued. Examples of the various fixes and enhancements were enabling the use of byte positions for Mark 5B modules that have lost their directories, and enabling the processing of 16 phase cal tones. Support continues for day-to-day problems and occasional bug fixes.

## 3. Experiments Correlated

In 2008, thirty-one geodetic VLBI experiments, consisting of ten R&Ds, two T2s, and nineteen test experiments, were processed at the Haystack correlator. The test experiments cover the broadband development and a wide assortment of other projects, some of which were mentioned in the summary above. As usual, there was also a large number of smaller tests that are not included in the above count because they were too small to warrant individual experiment numbers.

## 4. Current/Future Hardware and Capabilities

As of the end of 2008, functioning hardware installed on the system included 2 tape units, 7 Mark 5A units, 7 station units, 4 Mark 5B units (DOMs) with their associated correlator interface boards (CIBs), 16 operational correlator boards, 2 crates, and miscellaneous other support hardware. We have the capacity to process all baselines for 11 stations simultaneously in the standard geodetic modes, provided the aggregate recordings match the above hardware matrix.

The only change in the above described matrix compared to last year is the addition of one Mark 5B unit. We temporarily had a total of six Mark 5B units installed for the processing of u-VLBI project experiments but had to relinquish two of them later for other projects. One retired tape drive was removed from the equipment line in order to make rack space for the additional Mark 5B unit mentioned above. Installation and organization of the Mark 5B units were revised extensively at this time and at various other times during the year. The electrical circuit distribution for the correlator rack was re-wired this year in order to better distribute its load.

In 2009, we hope for an expansion of stations recording on Mark 5B units, which would allow for the retirement of station units and thus an increase in the use of Mark 5B playback units on the correlator. This will improve processing reliability and provide the opportunity to process more stations simultaneously.

## 5. Staff

Staff who participated in aspects of Mark IV, Mark 5, and e-VLBI development and operations include:

### 5.1. Software Development Team

- John Ball - Mark 5A/5B; e-VLBI
- Roger Cappallo - real-time correlator software and troubleshooting; system integration; post processing; Mark 5B/5C; Linux conversion; e-VLBI
- Kevin Dudevoir - correlation; maintenance/support; Mark 5A/5B/5C; e-VLBI; Linux conversion
- Chester Ruszczyk - e-VLBI; Mark 5A/5B/5C
- Jason SooHoo - e-VLBI; Mark 5A/5B/5C
- Alan Whitney - system architecture; Mark 5A/5B/5C; e-VLBI

### 5.2. Operations Team

- Peter Bolis - correlator maintenance
- Brian Corey - experiment correlation oversight; station evaluation; technique development
- Dave Fields - playback drive maintenance; Mark 5 installation and maintenance; general technical support
- Glenn Millson - correlator operator
- Arthur Niell - technique development
- Don Sousa - correlator operator; experiment setup; tape library and shipping
- Mike Titus - correlator operations oversight; experiment setup; computer services; software and hardware testing
- Ken Wilson - correlator maintenance; playback drive maintenance; general technical support

## 6. Conclusion/Outlook

Migration of additional correlator run-time programs to the Linux platform is expected in the coming year. Expansion of the use of Mark 5B units at all correlators will continue as more field stations convert to Mark 5B. Mark 5C testing is beginning. e-VLBI testing should resume this year with the restoration of the high speed link. Further use of DBEs will continue, with the intent of transforming standard observing techniques to higher data rates in the coming years. This is an exciting time at the Haystack correlator, as much of the testing and development of new equipment in previous years is now coming to fruition, resulting in larger and more extensive experiments.

## IAA Correlator Center

*Igor Surkis, Artemy Fateev, Alexey Melnikov, Vladimir Mishin, Violet Shantyr,  
Vladimir Zimovsky*

### Abstract

The prototype correlator of ARC was produced. It is a 2-station VSI-H XF-type hardware VLBI correlator connected to two Mark 5B terminals. The fullscale 6-station VLBI correlator ARC is scheduled next and will be constructed soon.

The VLBI data of the 3-station sessions of the Russian national network Quasar was processed using the MicroPARSEC correlator.

### 1. Introduction

The IAA Correlator Center is located and staffed by the Institute of Applied Astronomy in St.-Petersburg, Russia.

The IAA Correlator Center is devoted to processing geodetic, astrometric, and astrophysical observations made with the Russian national VLBI network Quasar.

### 2. Summary of Activities

Development of the basic parts of the VLBI hardware XF Astrometric Radiointerferometric Correlator (ARC) was completed in 2008. The first prototype correlator was built.

The ARC hardware construction allows the formation of different scales of correlators, from single-baseline 2-station up to 15-baseline 6-station correlators, with 16 frequency channels in each baseline.

The ARC handles two-bit VLBI signals with a 32 MHz maximal TAC frequency. The maximal data range from each station is 1 Gbps. The ARC requires VSI-H input VLBI signals. It is equipped with Mark 5B playback terminals. The ARC hardware includes a Base Module of Correlator, Signal Distribution and Synchronization System, and standard computer and communication units.

The main part of the ARC is called the Base Module of Correlator (BMC). This device carries out all the hardware data processing. The BMC enables the processing of 16 single-baseline frequency channels of typical geodetic VLBI observations. The BMC contains 16 correlation units which are single-baseline single-channel XF correlators for calculating 64 complex delays and picking phase-cal tones. The BMC is based on FPGA technology. The data processing algorithms are implemented as FPGA firmware. The BMC is a Compact PCI 6U front plug-in board. It contains 34 FPGA, 32 RAM chips and a PCI controller chip.

The Signal Distribution and Synchronization System (SDSS) distributes signals from Mark 5B to BMC, so that each BMC receives signals from two Mark 5B terminals. In addition, the SDSS generates and sends synchronization signals DPSCLOCK and DPS1PPS to Mark 5B terminals. The SDSS has several types of Compact PCI boards in its constructions: Generator of Synchronization Signals, Signal Distribution Module, and Interface Module of Correlator.

The Generator of Synchronization Signals (GSS) produces DPSCLOCK and DPS1PPS signals and passes these to the Mark 5B terminals.

The main part of data stream distribution is performed by Signal Distribution Modules (SDM).

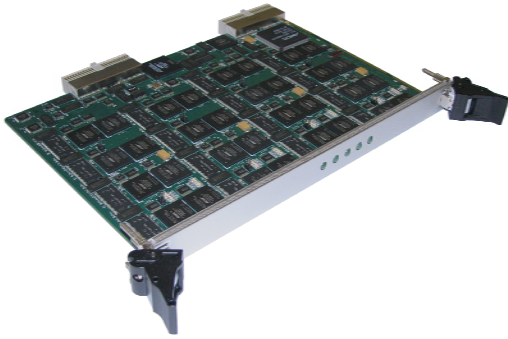

Figure 1. BMC device.

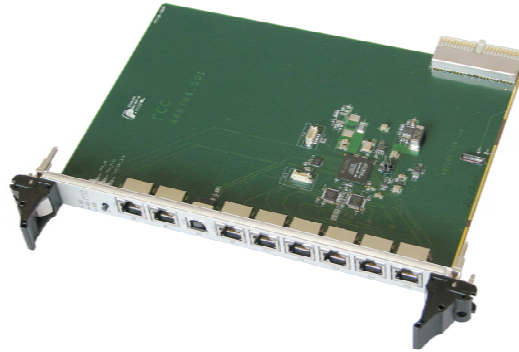

Figure 2. GSS device.

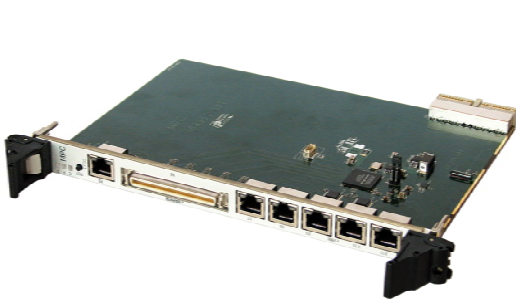

Figure 3. SDM device.

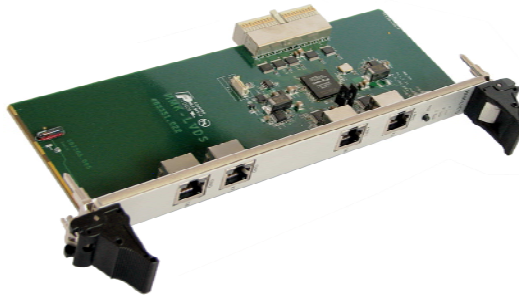

Figure 4. IMC device.

Up to five copies (for a 6-station correlator) of the Mark 5B output data streams from each of the Mark 5B terminals are produced by the SDM and then sent to the IMC.

The Interface Module of Correlator (IMC) receives 2 serial data streams coming from 2 SDMs, and transfers these to the BMC.

The SDM and GSS are the Compact PCI 6U front plug-in boards. The IMC is the Compact PCI 6U rear panel I/O board. The BMC, GSS, SDM and IMC modules are shown in Figs. 1, 2, 3, 4.

During 2008 the first prototype correlator of the ARC family was produced. It was built as a 2-station correlator, and a series of geodetic VLBI observations was performed to test this correlator in determining UT1-UTC. The prototype consists of two Mark 5B terminals, a Compact PCI 6U crate (Fig. 5) with BMC, GSS, two SDM and IMC modules, local network commutator, and PC.

The prototype hardware control is performed from the PC, which is connected to the crate through the correlator's local network. The correlator software is a distributed system between the PC and crate. The software is executed on Linux.

Fullscale ARC production started at the end of 2008. The goal for the 6-station 15-baseline correlator is the processing of all data from the national VLBI sessions. (At present this task is performed with the 12-board MicroPARSEC correlator.) We are planning to complete the 6-station ARC in 2009.

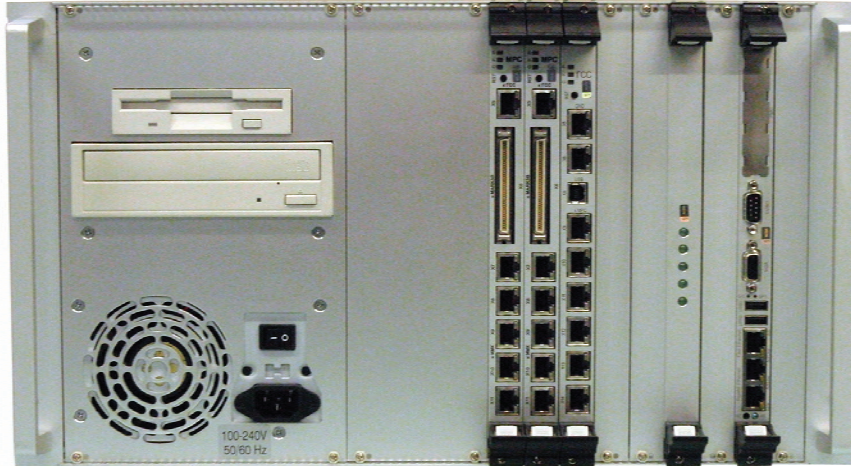

Figure 5. Compact PCI 6U crate.

### 3. Experiments Done

The regular national VLBI observations with the 3-station Quasar VLBI network were continued in 2008. Observational data were processed using the 12-board MicroPARSEC correlator. A total of twenty 24-hour and sixteen 8-hour VLBI sessions were processed. The resulting group and ionospheric delay accuracy varies from 50 to 100 picoseconds.

### 4. Staff

- Igor Surkis — leading investigator, software developer;
- Artemy Fateev — software developer;
- Alexey Melnikov — software developer, scheduler;
- Vladimir Mishin — software developer, post processing;
- Violet Shantyr — software developer, post processing;
- Vladimir Zimovsky — hardware developer.

# VLBI Correlators in Kashima

*Mamoru Sekido, Moritaka Kimura*

## Abstract

Software correlator systems developed at Kashima Space Research Center are used for data processing of R&D VLBI experiments. Major correlation tasks processed in 2008 were the following three: e-VLBI project for rapid UT1 measurement, CARAVAN2400 project for reference baseline determination with small diameter antennas, and a project for time standards comparison with VLBI. An automatic data processing scheme, which distributes correlation tasks to a cluster of PCs for parallel processing, has been extensively used for this geodetic VLBI processing.

## 1. General Information

The VLBI group of Kashima Space Research Center (KSRC) of National Institute of Information and Communications Technology (NICT: Fig.1) has been contributing to the VLBI community by developing the VLBI data acquisition system (DAS) and the correlation systems. Both systems are named K5.

The complete 16 channel set of the K5/VSSP DAS system has been used at the Kashima 34m, Tsukuba 32m, and Mizusawa 20m VERA station of National Astronomical Observatory of Japan (NAOJ) for geodetic VLBI observations. Also a subset of the DAS has been installed at Gifu Univ.'s 11m station, Hokkaido Univ.'s 11m station, and Yamaguchi Univ.'s 32m station, and they are used for astrophysical line spectrum observations.

e-VLBI technology has been intensively developed in recent years. International e-VLBI experiments for ultra-rapid UT1 measurements have been conducted as a pilot project for testing the stability of operation. Also we have participated in several e-VLBI demonstration events, and the K5 DAS system's compatibility with foreign DAS systems has improved through those international experiments.

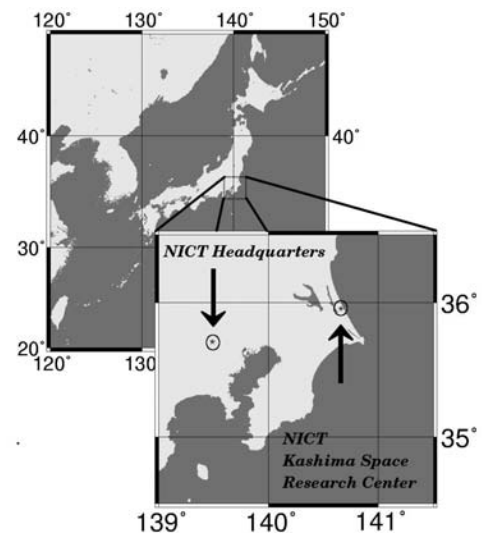

Figure 1. Location of NICT/KSRC.

## 2. Component Description

NICT has developed two kinds of DASs, and they are named K5/VSI and K5/VSSP [1, 2], respectively. Two sorts of software correlators have been developed for each of them. Table 1 summarizes the differences between the two sorts of DAS systems and the corresponding software correlator packages. T. Kondo has developed the K5 software correlator [3] for the correlation of K5/VSSP data. Hereafter “K5 software correlator” means “cor & fx\_cor” system, except for wherever “K5/VSI correlator” is clearly stated. The “cor & fx\_cor” system has been used for geodetic data processing such as UT1 measurements. This software package includes a data format converter between K5/VSSP and Mark 5A [4]. Thus the K5 software correlator can perform not

Table 1. Two kinds of K5 software correlators and the corresponding DAS systems.

Name of Module	Corresponding DAS System	Number of Data Channels	Processing Speed	Main Developer	Applications
cor & fx_cor	K5/VSSP, K5/VSSP32	4 x 4ch	Medium	T.Kondo	Geodesy UT1
GICO3	K5/VSI	1ch (~ N)	Fast	M.Kimura	Astronomy VERA Project

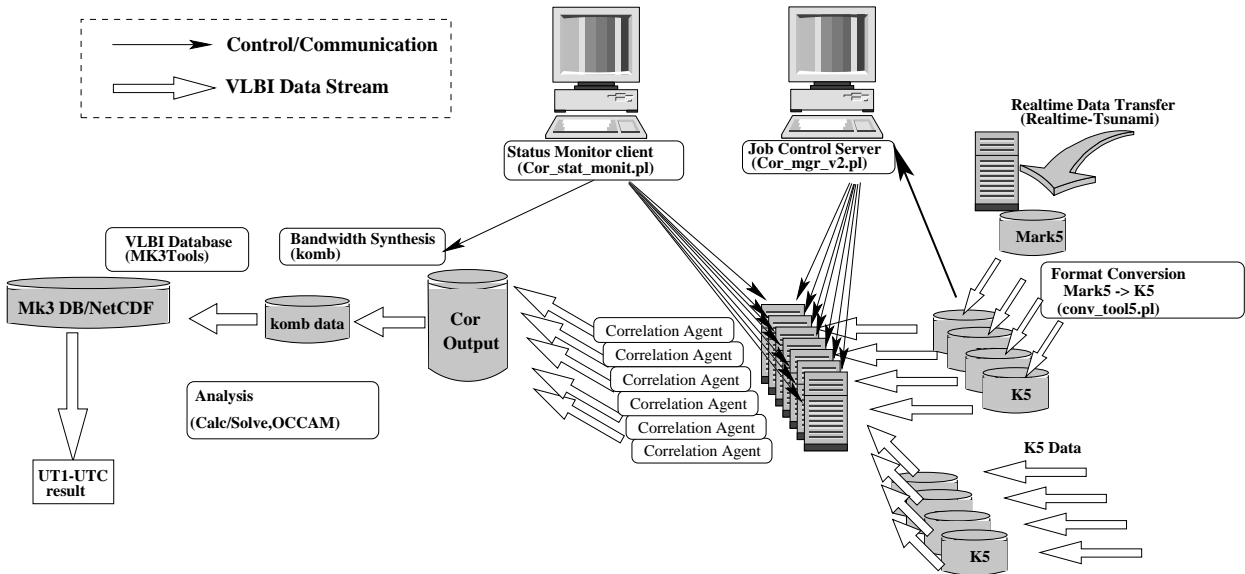

Figure 2. Distributed software correlation system with a cluster of PCs.

only native correlation processing of K5/VSSP data but also mixed correlation with Mark 5A and K5 via data conversion. This function has been used in International e-VLBI observation for ultra-rapid UT1 measurements [5].

A subsidiary software package for distributed correlation processing has been written in Perl. Figure 2 shows the schematic diagram of the data processing system. The software modules written in Perl scripts communicate with each other, and they accomplish the distributed data processing. The data conversion (Mark 5A→K5) and correlation processing tasks are invoked from the scripts. This correlation system has been used for e-VLBI experiments for ultra-rapid UT1 measurements [6] and for the other geodetic VLBI experiments, as well.

### 3. Staff

- Tetsuro Kondo is in charge of development and maintenance of software correlator package (cor & fx\_cor). Also he is in charge of development of PC-based VLBI sampler K5/VSSP32 [2]. He has been working now at Ajou University in Korea on the construction of a geodetic VLBI system in Korea, since April 2008.
- Yasuhiro Koyama is Group leader of “Space-Time Application Group” and is in charge of

overall activity in our group. He moved to NICT Headquarters in Tokyo in August 2008.

- Ryuichi Ichikawa has been the leader of the VLBI project in Kashima since August 2008. He is in charge of the MARBLE project, in which a small-size VLBI station has been developed for providing length-standards for GSI.
- Mamoru Sekido is in charge of the e-VLBI activity.
- Moritaka Kimura is working on the development of a high speed Gigabit software correlator. He is in charge of development of software correlators for the VERA project.
- Thomas Hobiger is developing a new VLBI database system by using NetCDF. He also performs research into atmospheric path delay calibration with the ray tracing technique.
- Eiji Kawai is in charge of maintenance of the 34m telescope and is responsible for the operation of the 34m telescope and DAS for IVS VLBI sessions.
- Masanori Tsutsumi is working as a system engineer for computer maintenance.

## 4. Current Status and Activities

### 4.1. Ultra-rapid UT1 Measurements

Rapid UT1 measurements have been conducted under the collaboration of NICT, Geographical Survey Institute (GSI) Japan, Onsala Space Observatory (Sweden), and Metsähovi Radio Observatory (Finland). The aim of this project is testing and improving the software correlation system with e-VLBI to achieve minimum latency in VLBI UT1 sessions. UT1 estimation has become available within 30 minutes of session termination by using a mixture of K5 and Mark 5 systems on international baselines. A record minimum latency of less than 4 minutes was achieved on February 22 on the Tsukuba-Onsala baseline with a 256 Mbps data rate. The observation and correlation were performed by Onsala and GSI. NICT contributed to this by providing an automatic correlation system, automatic Mark III database creation via NetCDF<sup>1</sup> (MK3TOOLS [7]), and an automatic UT1 analysis scheme with OCCAM developed by T.Hobiger. A list of our e-VLBI UT1 experiments is available on the Web<sup>2</sup>.

### 4.2. e-VLBI Development

Data format/interface compatibility with Mark 5B has significantly improved with the combination ADS-2000 sampler and K5/VSI DAS. A software package for real-time data stream transmission with a protocol of UDP/IP has been developed. The first realtime e-VLBI experiment with ATNF was realized in June. Further improvement has continued and has contributed to an e-VLBI demonstration for the International Year of Astronomy in 2009 conducted by JIVE.

### 4.3. GICO3 Correlator for K5/VSI

A software correlation system using high speed correlation software named GICO3 is under development for NAOJ's VERA project [8]. The system is designed for processing 10 baselines by

---

<sup>1</sup><http://www.unidata.ucar.edu/software/netcdf/>

<sup>2</sup><http://www2.nict.go.jp/w/w114/stsi/research/e-VLBI/e-VLBI-frame.html>



Table 2. Picture and Specification of Software Correlator for VERA Project



Specification parameters of the Software Correlator

Stations	5
Baselines	10
Processing Rate	512 - 1024 Mbps/station
Lags Number	64 - 64000 points
Output	10 cross and 5 auto correlations
Output rate	1 - 100Hz
Output format	CODA, FITS

cross-correlation and 5 stations by auto-correlation, simultaneously [9]. The maximum data rate is 1 Gbps for each station. A picture of the K5/VSI correlation system is displayed in Table 2.

## 5. Future Plans

Geodetic application of the GICO software correlator will be one target, and it will expand the capability of co-observation with Mark 5B stations. Software to adopt to VDIF (VLBI Data Interchange Format) will be developed.

## References

- [1] T. Kondo, et al.: Technology Development Center at NICT, IVS 2007 Annual Report, edited by D. Behrend and K. Baver, NASA/TP-2008-214162, 2008.
- [2] T. Kondo, et al.: Development of a New VLBI Sampler Unit (K5/VSSP32) Equipped with a USB 2.0 Interface, IVS 2006 General Meeting Proceedings, edited by Dirk Behrend and Karen Baver, NASA/CP-2006-214140, p.195-199, 2006.
- [3] Y. Koyama, et al.: Evaluation of the K5 system in geodetic VLBI experiments, Technical Development Center News CRL, No.23, 26-30, 2003.
- [4] Whitney, A.R.: Mark IIIA/IV/VLBA Tape Formats, Recording Modes and Compatibility \*Supercedes Memo #205 + Revisions, Mark IV Memo Series, <http://www.haystack.edu/geo/mark4/memos.html>, **230A**, 2005.
- [5] Sekido. M., et al.: Ultra-rapid UT1 measurement by e-VLBI, Earth Planets and Space, **60**, pp,865-870, 2008.
- [6] Sekido, M. et al.: Development of e-VLBI Technologies for Ultra-rapid UT1 Measurement, IVS NICT-TDC News, <http://www2.nict.go.jp/w/w114/stsi/ivstdc/news-index.html>, **No.29**, pp. 28-30, 2008.
- [7] Hobiger, T. et al.: MK3TOOLS & NetCDF – storing VLBI data in a machine independent array oriented data format, Proceedings of the 18th European VLBI for Geodesy and Astrometry (EVGA) Working Meeting April 12, 2007, Vienna, Austria, <http://mars.hg.tuwien.ac.at/evga/>, P03, 2007.
- [8] M. Honma et al.: Multi-Epoch VERA Observations of H<sub>2</sub>O Masers in OH 43.9 – 0.1, Publ. Astron. Soc. Japan Vol 57 pp. 595-603, 2005.
- [9] M. Kimura: Development of the software correlator for the VERA system, Technical Development Center News NICT, No.26, 26-27, 2005.

# Tsukuba VLBI Correlator

*Hiromi Shigematsu, Shinobu Kurihara, Kensuke Kokado, Kentarou Nozawa*

## Abstract

This is a report of the activities at the Tsukuba VLBI Correlator in 2008. The Tsukuba VLBI Correlator processed 99 intensive sessions (IVS-INT2), nine JADE sessions and two geodetic sessions for JAXA. Additionally, we processed ultra-rapid dUT1 e-VLBI experiments and obtained UT1-TAI only 3 minutes 45 seconds after the end of the observing sessions.

## 1. General Information

The Tsukuba VLBI Correlator is situated at the Geographical Survey Institute (GSI) in Tsukuba, Japan. It is a part of the VLBI components operated by GSI, together with the Tsukuba 32-m VLBI station (TSUKUB32). There are two K5/VSSP correlator units. Intensive sessions (IVS-INT2), performed on Saturdays and Sundays on the TSUKUB32–WETTZELL baseline for monitoring UT1-UTC, have been correlated at the Tsukuba VLBI Correlator. The processing of the JADE series (geodetic sessions with domestic VLBI network of GSI) is also a major task of the Tsukuba VLBI Correlator.

## 2. Component Description

Both the K5/VSSP correlator units “system 1” and “system 2” have been in operational use. A component description for both units is presented in Table 1.

Removable disk cartridges from the stations are connected to a data server in an external mounting mode. Each data server can share a couple of disk cartridges at once through a drive unit. The data servers can perform distributed computing, as well as function as correlation servers. File handling and multi-task control is assumed by the management computer. There is no need to assemble a K5/VSSP correlator unit from individual components; an off-the-shelf computer provides sufficient hardware to support a K5/VSSP correlator unit.

Software correlation processing with the K5/VSSP correlation unit is based on IP-VLBI technology. It has been developed at NICT (National Institute of Information and Communications Technology, Japan). The most essential elements are four kernel programs: “apri\_calc”, “cor”, “sdelay” in correlation package “ipvlbi20080930”, and “komb” in “komb20080219”. These K5/VSSP packages are licensed by NICT. Based on an agreement about research cooperation between GSI and NICT, the Tsukuba VLBI Correlator is allowed to take advantage of the products. “apri\_calc” calculates the a priori delay and rate for each scan per single baseline. “cor” executes software correlation. “sdelay” makes coarse fringes directly from correlator output. “komb” is a bandwidth synthesis program to obtain multi-channel delays. K5/VSSP also has a conversion program; it can convert K5 to Mark 5 format and vice versa.

The kernel programs only have the capability of processing one single baseline scan. To meet the demands for processing many scans for multi-baselines, a simple way of distributed computing is brought into the unit. Once there is an uncorrelated data set, the task for it is distributed to any vacant correlation server. The auxiliary application software “PARNASSUS” handles the detailed control of processing multiple tasks. The acronym “PARNASSUS” stands for Processing

Application in Reference to NICT's Advanced Set of Softwares Usuable for Synchronization. The latest version PARNASSUS 1.3, developed at GSI and released March 2006, is installed in the management computer. PARNASSUS serves the operator as a tool, providing a graphical user interface and facilitating multi-task control. MK3TOOLS [1] developed by NICT is installed on a Linux computer to make Mark III databases. CALC/SOLVE developed by NASA/GSFC is installed on a Linux computer to produce primary solutions.

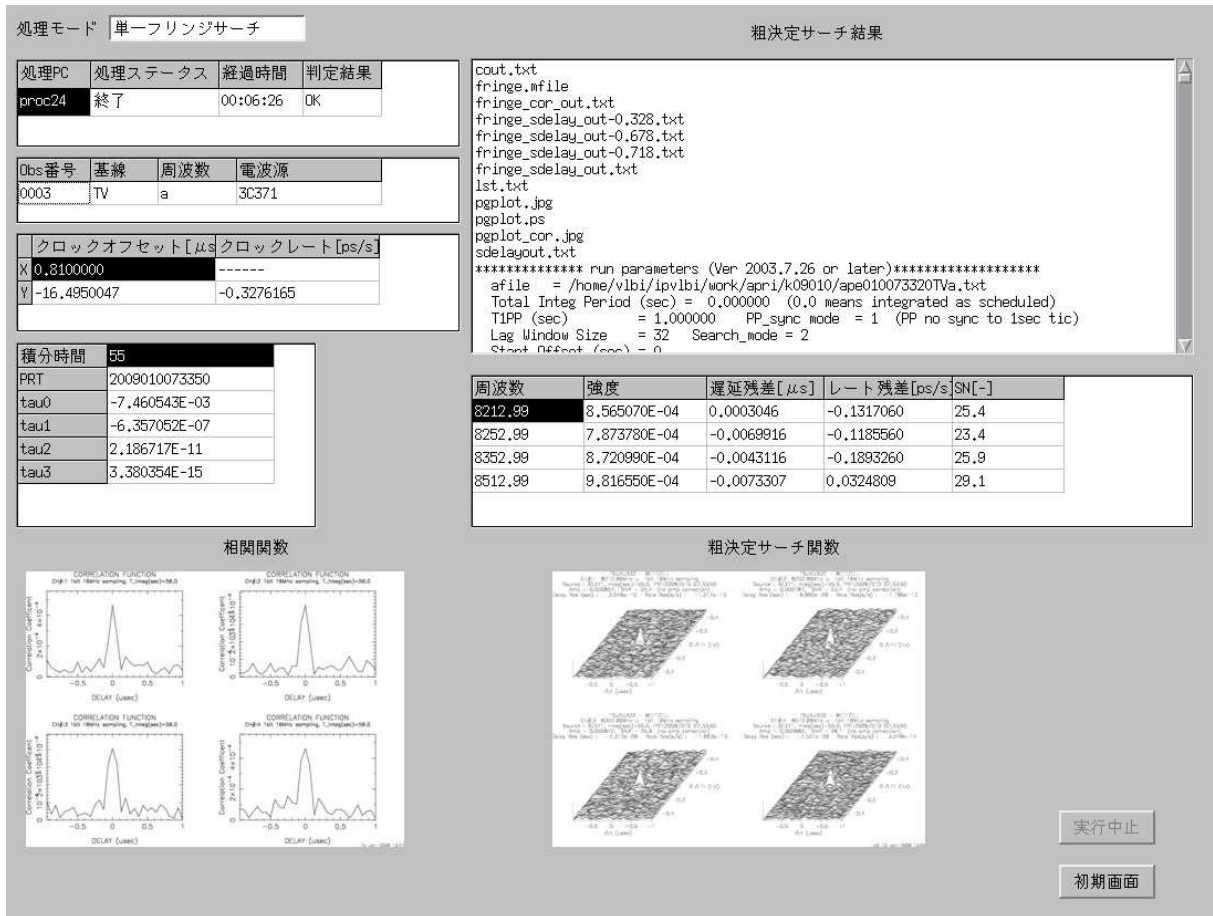

Figure 1. The fringe decision result from Parnassus.

### 3. Staff

A list of the staff at the Tsukuba VLBI Correlator in 2008 is given below. Routine operations were mainly performed under contract with Advanced Engineering Services Co., Ltd (AES) 227 days in the 2008 fiscal year (April 2008 through March 2009). Among the operations of 227 days, the operations for 20 days were funded by the National Astronomical Observatory in Japan (NAOJ) and the operations for 7 days were funded by the Japan Aerospace Exploration Agency (JAXA). Staff in the observation domain are listed in the report of the Tsukuba 32-m VLBI station in the Network Stations section of this volume.

Table 1. Component description of the Tsukuba correlator

	system 1	system 2
management computer (CPU)	1 Intel Pentium 4, 3.0 GHz	1 Intel Pentium 4, 3.0 GHz
data servers (CPU)	23 Intel Pentium 4, 3.0 GHz	8 Intel Pentium 4, 3.4 GHz
correlation servers (CPU)	16 (rackmount type computer) Intel Xeon 3.06 GHz (dual CPUs)	12 (rackmount type computer) Intel Xeon 3.4 GHz (dual CPUs)
format	K5/VSSP	
media type	SATA disk cartridge	
kernel program package	ipvlbi20080930, komb20080219	
aid application	PARNASSUS 1.3	
OS	Linux	
operation	JADE	IVS-INT2
installation	April 2008	August 2006

- Shigeru Matsuzaka : Head of Space Geodesy Division
- Kozin Wada : Deputy head of Space Geodesy Division
- Shinobu Kurihara : Responsible official
- Hiromi Shigematsu : Correlation chief, system manager
- Kensuke Kokado : Technical staff
- Kentarou Nozawa : Technical staff (AES)
- Yasuko Mukai : Technical staff (AES)

#### 4. Current Status and Activities

During 2008, 99 intensive sessions (IVS-INT2) on TSUKUB32-WETTZELL or KASHIM34-WETTZELL single baseline for dUT1 determination and nine JADE sessions were processed at the Tsukuba VLBI Correlator. Almost all the data was processed correctly. Significantly, despite 2-bit sampling data, the correlation of jd0811 was not a problem either.

Two 24-hour geodetic sessions (the u08020 and u08170 sessions) were also processed at the Tsukuba VLBI Correlator. The u08020 session, conducted under GSI's initiative, aimed at the improvement of the UCHINOOR site position. The u08170 session, conducted under GSI's initiative, aimed at the improvement of the USUDA64 site position. UCHINOOR, 32-m in diameter, and USUDA64, 64-m in diameter, belong to and are funded by JAXA as tracking antennas for deep space missions. The processing of u08020 and u08170 was funded by JAXA.

Four ultra-rapid dUT1 e-VLBI sessions were processed at the Tsukuba VLBI Correlator in the form of test experiments. UT1-TAI was successfully obtained only 3 minutes 45 seconds after the end of the observing sessions. Since then, we have been attempting a 512 Mbps transfer rate, but we have not succeeded so far.

The e-VLBI correlation of the INT2 sessions has been possible since April, 2008. As the data transfer is done while observing, the correlation is immediately done by an automated operation

after the session. We do not have to correlate on Monday, and the database submission has become quicker than before, but only if there is no failure in the data transfer, the data conversion and the fringe detection.

A new computer was introduced to “system 1” as it became superannuated. To deal with high-speed processing for the Intensive sessions, the number of correlation servers was increased from 8 to 12. Moreover, because several data servers had broken down after two years of operation, we added 8 servers to “system 1”.

## 5. Plans for 2009

- We will continue to process the TSUKUB32/WETTZELL Intensive sessions (IVS-INT2) with the K5/VSSP system. The sessions are scheduled for Saturdays and Sundays with K5/VSSP (TSUKUB32) and Mark 5 (WETTZELL) systems. The Tsukuba VLBI Correlator is also expected to be responsible for processing several JADE sessions.
- We will add some more correlation servers and data servers to the existing K5/VSSP correlation units. At the same time, overloaded servers will be replaced by modern Linux machines to recover the proper performance of the K5/VSSP correlation units. In addition, the interface devices of the drive units have been gradually damaged through frequent loading of disk cartridges into the drive slots. The recovery process requires an overhaul of the drive units for both correlator and station use.
- Discussions for the next version of “PARNASSUS” will be continued. The current style of distributed computing appears not to be optimized for obtaining the greatest performance from the dual CPU capacity of the correlation server. To make multi-task processing in dual CPU mode effective, we plan to upgrade PARNASSUS by improving the access control to each correlation server. In order to fix sudden interruptions of the computing process on a machine, our action plan will address our software and hardware. New features will be introduced into PARNASSUS, such as handling each task’s information in a random manner and sorting access control first by baseline and then by scan number in order to avoid frequent access to a specific data server. The interaction among servers will be redesigned to keep the data processing running.
- We will use OCCAM as well as CALC/SOLVE for the primary solutions of the INT2 sessions. The database generation software MK3TOOLS is able to make the Mark III database and the NGS file by using NetCDF, and it is possible to solve by the automatic operation. Therefore, INT2 sessions will be solved by OCCAM, and the result will be delivered to the IVS mailing list in the future. This processing can be done by automation. We want to obtain the analytical result within a few minutes after the end of the session.

## References

- [1] Y. Koyama, M. Sekido, T. Hobiger, H. Takiguchi and T. Kondo: Developments of automated data processing system for ultra rapid dUT1 e-VLBI sessions, The 5th IVS General Meeting Proceedings, 2008, p. 405-409

# Washington Correlator

*Kerry A. Kingham, David M. Hall*

## Abstract

This report summarizes the activities of the Washington Correlator for the year 2008. The Washington Correlator provides up to 80 hours of processing per week, primarily supporting Earth Orientation and astrometric observations. An additional 40 hours per week of unattended processing is also provided routinely. In 2008 the major programs supported include the IVS-R4, IVS-INT, IVS-R1, CONT08, APSG, and CRF (CRF, CRMS, CRDS, and CRFS) observing sessions.

## 1. Introduction

The Washington Correlator (WACO) is located at and staffed by the U. S. Naval Observatory (USNO) in Washington, DC, USA. The correlator is sponsored and funded by the National Earth Orientation Service (NEOS) which is a joint effort of the USNO and NASA. Dedicated to processing geodetic and astrometric VLBI observations, the facility spent 100 percent of its time on these experiments. All of the weekly IVS-R4 sessions, all of the daily Intensives, several IVS-R1 sessions, and the entire CONT08 were processed at WACO. The remaining time was spent on terrestrial reference frame and astrometry sessions. The facility houses a Mark IV Correlator.

## 2. Correlator Operations

- The Washington Correlator continues to operate 80 hours per week with an operator on duty. The correlator has continued to function well unattended, allowing another 40 hours per week, on average, of extra processing. This has also decreased the time it takes to process an R4 or R1 by one day, and allowed more rapid processing of CONT08 sessions.
- The correlator staff continues the testing and repair of Mark 5 modules. Not only were failed disks replaced, but some modules were upgraded by the replacement of small disks with larger ones.
- The Intensive observations from Wettzell continue to be electronically transferred to the Washington area and transported to the correlator. This operation saves 1 to 2 days of shipping time.
- A new control computer was brought online in 2008, and the entire Correlator was moved behind an internal firewall to isolate it from the rest of the USNO computer network.
- A Mark 5B playback unit was added to the correlator complement of Mark 5's, which now allows the correlator to process 10 stations (8 Mark 5As and 2 Mark 5Bs) simultaneously. In addition, a Mark 5B+ was acquired, although it is not yet online.
- Table 1 lists the experiments processed during 2008.

## 3. Staff

The Washington Correlator is under the management and scientific direction of the Earth Orientation Department of the U.S. Naval Observatory. USNO personnel continue to be responsible



Figure 1. The WACO Mark IV Correlator, showing the Mark 5B units (right), legacy tape drives (no longer used), the central processing rack and beyond it one of two station unit racks. The far left rack contains four Mark 5A units and the broadband Internet terminal.

Table 1. Experiments processed during 2008

52	IVS-R4 experiments
19	CRF (Celestial Reference Frame)
4	IVS-R1
15	CONT08
1	Station Test
212	Intensives
24	Kk-Sv-Wz Intensives

for overseeing scheduling and processing. During the period covered by this report, a private contractor, NVI, Inc., supplied a contract manager and correlator operators.

Table 2 lists staff and their duties.



Figure 2. Kenneth Potts keeps an eye on the correlator.

Table 2. Staff

Staff	Duties
Dr. Kerry Kingham (USNO)	Head VLBI Operations Division and Correlator Project Scientist
David Hall (USNO)	VLBI Correlator Project Manager
Bruce Thornton (NVI)	Operations Manager
Harvis Macon (NVI)	Lead Correlator Operator
Roxanne Inniss (NVI)	Media Librarian
Kenneth Potts (NVI)	Correlator Operator

#### 4. Outlook

The Washington Correlator plans to upgrade the Mark 5A playbacks to Mark 5B, in coordination with the installation of Mark 5Bs at the Network Stations. It is expected that the number of playbacks available will increase to 12 (8 Mark 5As and 4 Mark 5Bs) with the addition of 1 Mark 5B and 1 Mark 5B+ before the existing Mark 5A units are converted to Mark 5B.

At the end of 2008 a broadband Internet connection was in the process of being installed at the Correlator.





**Data Centers**

**Data Centers**



# BKG Data Center

*Volkmar Thorandt, Reiner Wojdziak*

## Abstract

This report summarizes the activities and background information of the IVS Data Center for the year 2008. Included are information about functions, structure, technical equipment, and staff members of the BKG Data Center.

## 1. BKG Data Center Functions

The BKG (Federal Agency for Cartography and Geodesy) Data Center is one of the three IVS Primary Data Centers. It archives all VLBI related data of IVS components and provides public access for the community. The BKG Data Center is connected to the OPAR and CDDIS Data Centers by mirroring the OPAR and the CDDIS file stocks several times per day. The following sketch shows the principle of mirroring:

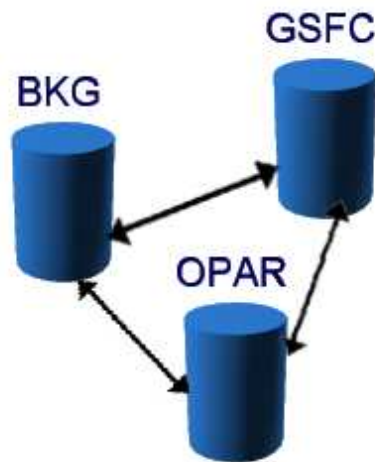

Figure 1. Principle of mirroring

IVS components can choose one of these Data Centers to put their data into the IVS network by using its incoming area which each of them has at its disposal. The BKG incoming area is protected, and users need to obtain the username and the password to get access. (Please contact the Data Center staff.)

An incoming script is watching the incoming area and checking the syntax of the files sent by IVS components. If it is o.k. the script moves the files into the data center directories; otherwise the files will be sent to a badfile area. Furthermore, the incoming script informs the responsible staff at the Data Center by sending e-mails about its activities. The incoming script is a part of the technological unit which is responsible for managing the IVS and the Operational Data Center and for carrying out the first analysis steps in an automatic manner. All activities are monitored to guarantee data consistency and to control all analysis steps from data arrival to delivering of analysis products to IVS.

Public access to the BKG Data Center is available through FTP and HTTP:

FTP: `ftp://ivs.bkg.bund.de/pub/vlbi/`

HTTP: `http://ivs.bkg.bund.de/vlbi/`

Structure of BKG IVS Data Center:

```
vlbi/           : root directory
ivs-special/   : special CRF investigations
ivscontrol/    : controlfiles for the data center
ivsdata/       : VLBI observation files
ivsdocuments/ : IVS documents
ivsproducts/   : analysis products
  crf/         : celestial frames
  trf/         : terrestrial frames
  eops/        : earth orientation (24h sessions)
  eopi/        : earth orientation (Intensive sessions)
  daily_sinex/ : daily sinex files (24h sessions)
  int_sinex/   : daily sinex files (Intensive sessions)
  trop/        : troposphere
```

## 2. Technical Equipment

DELL Server (SUSE Linux Enterprise 9.5 operating system)  
disk space: 500 GBytes (Raid system)  
backup: automatic tape library

## 3. Staff Members

Volkmar Thorandt (coordination, data analysis, data center, volkmar.thorandt@bkg.bund.de)  
Reiner Wojdziak (data center, Web design, reiner.wojdziaak@bkg.bund.de)  
Dieter Ullrich (data analysis, data center, dieter.ullrich@bkg.bund.de)  
Gerald Engelhardt (data analysis, gerald.engelhardt@bkg.bund.de)

# CDDIS Data Center Summary for the IVS 2008 Annual Report

*Carey Noll*

## Abstract

This report summarizes activities during the year 2008 and future plans of the Crustal Dynamics Data Information System (CDDIS) with respect to the International VLBI Service for Geodesy and Astrometry (IVS). Included in this report are background information about the CDDIS, the computer architecture, staff supporting the system, archive contents, and future plans for the CDDIS within the IVS.

## 1. Introduction

The Crustal Dynamics Data Information System (CDDIS) has supported the archiving and distribution of Very Long Baseline Interferometry (VLBI) data since its inception in 1982. The CDDIS is a central facility providing users access to raw and analyzed data to facilitate scientific investigation. The CDDIS archive of GNSS (GPS and GLONASS), laser ranging, VLBI, and DORIS data is stored on-line for remote access. Information about the system is available via the Web at the URL <http://cddis.gsfc.nasa.gov>. The current and future plans for the system's support of the IVS are discussed below.

## 2. System Description

The CDDIS archive of VLBI data and products is accessible to the public via anonymous ftp access.

### 2.1. Computer Architecture

The CDDIS is operational on a dedicated server, [cddis.gsfc.nasa.gov](http://cddis.gsfc.nasa.gov). The system has over 5 Tbytes of on-line magnetic disk storage; over 1.2 Tbytes are devoted to VLBI activities. A dedicated DLT tape system is utilized for system backups. The CDDIS is located at NASA GSFC and is accessible to users 24 hours per day, seven days per week.

### 2.2. Staffing

Currently, a staff consisting of one NASA civil service employee and two contractor employees supports all CDDIS activities. (See Table 1 below.)

Table 1. CDDIS Staff

Name	Position
Ms. Carey Noll	CDDIS Manager
Dr. Maurice Dube	Head, CDDIS contractor staff and senior programmer
Ms. Ruth Labelle	Programmer

### 3. Archive Content

The CDDIS has supported GSFC VLBI coordination and analysis activities for the past several years through an on-line archive of schedule files, experiment logs, and data bases in several formats. This archive has been expanded for the IVS archiving requirements.

The IVS data center content and structure is shown in Table 2 below. (A figure illustrating the flow of information, data, and products between the various IVS components was presented in the CDDIS submission to the IVS 2000 Annual Report.) In brief, an incoming data area has been established on the CDDIS host computer, `cddis.gsfc.nasa.gov`. Using specified file names, operation and analysis centers deposit data files and analyzed results to appropriate directories within this filesystem. Automated archiving routines, developed by GSFC VLBI staff, peruse the directories and migrate any new data to the appropriate public disk area. These routines migrate the data based on the file name to the appropriate directory as described in Table 2. Index files in the main sub-directories under `ftp://cddis.gsfc.nasa.gov/pub/vlbi` are updated to reflect data archived in the filesystem. Furthermore, mirroring software has been installed on the CDDIS host computer, as well as all other IVS data centers, to facilitate equalization of data and product holdings among these data centers. At this time, mirroring is performed between the IVS data centers located at the CDDIS, the Bundesamt für Kartographie und Geodäsie in Leipzig, and the Observatoire de Paris.

The public filesystem in Table 2 on the CDDIS computer, accessible via anonymous ftp, consists of a data area, which includes auxiliary files (e.g., experiment schedule information, session logs, etc.) and VLBI data (in both data base and NGS card image formats). A products disk area has also been established to house analysis products from the individual IVS analysis centers as well as the official combined IVS products. A documents disk area contains format, software, and other descriptive files.

### 4. Data Access

During 2008, over 400 user organizations accessed the CDDIS on a regular basis to retrieve VLBI related files. These users downloaded over 13.5 Tbytes of data and products (640K files) from the CDDIS VLBI archive last year.

### 5. Future Plans

The CDDIS staff will continue to work closely with the IVS Coordinating Center staff to ensure that our system is an active and successful participant in the IVS archiving effort. Over the last two years, we have procured new computer hardware that will increase the CDDIS on-line disk storage capacity, ensure system redundancy, and better serve our user community. We hope to have this new system operational in the spring of 2009.

Table 2. IVS Data and Product Directory Structure

Directory	Description
Data Directories	
vlbi/ivsdata/db/yyyy	VLBI data base files for year <i>yyyy</i>
vlbi/ivsdata/ngs/yyyy	VLBI data files in NGS card image format for year <i>yyyy</i>
vlbi/ivsdata/aux/yyyy/sssss	Auxiliary files for year <i>yyyy</i> and session <i>sssss</i> ; these files include: log files, wx files, cable files, schedule files, correlator notes
vlbi/raw	Raw VLBI data
Product Directories	
vlbi/ivsproducts/crf	CRF solutions
vlbi/ivsproducts/eopi	EOP-I solutions
vlbi/ivsproducts/eops	EOP-S solutions
vlbi/ivsproducts/daily_sinex	Daily SINEX solutions
vlbi/ivsproducts/int_sinex	Intensive SINEX solutions
vlbi/ivsproducts/trf	TRF solutions
vlbi/ivsproducts/trop	Troposphere solutions
Project Directories	
vlbi/ivs-iers	IVS contributions to the IERS
vlbi/ivs-pilot2000	IVS Analysis Center pilot project (2000)
vlbi/ivs-pilot2001	IVS Analysis Center pilot project (2001)
vlbi/ivs-pilotbl	IVS Analysis Center pilot project (baseline)
vlbi/ivs-pilottro	IVS Analysis Center pilot project (troposphere)
vlbi/ivs-special	IVS special analysis solutions
Other Directories	
vlbi/ivscontrol	IVS control files (master schedule, etc.)
vlbi/ivsdocuments	IVS document files (solution descriptions, etc.)
vlbi/dserver	dserver software and incoming files

# Italy INAF Data Center Report

*M. Negusini, P. Sarti, C. Abbondanza*

## Abstract

This report summarizes the activities of the Italian INAF VLBI Data Center. Our Data Center is located in Bologna, Italy, and belongs to the Institute of Radioastronomy, which is part of the National Institute of Astrophysics. We also report about some changes in the hardware facilities devoted to IVS activities.

## 1. Introduction

The main analysis activity and storage is concentrated in Bologna, where we store and analyze single databases, using CALC/SOLVE software.

The IRA started to store geodetic VLBI databases in 1989, but the databases archived in Bologna mostly contain data including European antennas from 1987 onward. In particular most of the databases available here have VLBI data with at least three European stations. However we also store all the databases with the Ny-Ålesund antenna observations. In 2002 we decided to store the complete set of databases available on the IVS data centers, although we limited the time span to the observations performed from 1999 onwards. All the databases have been processed and saved with the best selection of parameters for the final arc solutions. In order to perform global solutions, we have computed and stored the superfiles for all the databases.

In some cases we have introduced GPS-derived wet delays into the European databases (1998 and 1999 EUROPE experiments, for the time being), as if they were produced by a WVR. These databases are available and stored with a different code from the original databases. In order to produce these databases, we have modified DBCAL, and this new version is available to external users.

## 2. Computer Availability and Routing Access

To date, the main computer is a Linux workstation, where Mark 5 Calc/Solve version 10 was installed and all VLBI data analysis migrated. The Internet address of this computer is sarip.ira.inaf.it. Since 2007 a new server with a storage capacity of 1 TB has been available and, therefore, all experiments performed in the previous years were downloaded and archived, thus completing the catalogue. The older experiments will be analyzed in order to perform global long term analysis. At present, the databases are stored in the following directories:

1 = /data2/dbase2

2 = /geo1/dbase1

3 = /geo1/dbase

4 = /geo1/dbase3

The superfiles are stored in:

/data1/super

The list of superfiles is stored in the file /data2/mk5/save\_files/SUPCAT. The username for accessing the databases is geo. The password may be requested by sending an e-mail to negusini@ira.inaf.it.



The HP 785/B2600 workstation is still maintained. The Internet address of this computer is boira3.ira.inaf.it, and the databases are stored in different directories and on different disks as well. The complete list of directories where databases are stored follows:

- 1 = /data1/mk3/data1
- 2 = /data1/mk3/data2
- 4 = /data6/dbase6
- 6 = /data5/dbase5
- 5 = /data4/dbase4
- 7 = /data7/dbase7
- 8 = /data8/dbase8
- 9 = /data9/dbase9

The username for accessing the database at the moment is geo. The password can be requested by sending an e-mail to negusini@ira.inaf.it.

The other workstation still working in Bologna is an HP282 computer with Internet address hp-j.ira.inaf.it. The databases are stored in the following directories:

- 7 = /data8/dbase8
- 8 = /data10/dbase10

The superfiles are stored in different directories:

- /data2/super
- /data10/super10
- /data9/super9
- /data8/super8

The list of superfiles is stored in the file /data6/solve\_files/SUPCAT. The area for data storage has a capacity of 366 gigabytes with the installation of an external server. The data can be accessed using the username geo, and the password can be requested by writing to negusini@ira.inaf.it.

# Data Center at NICT

*Yasuhiro Koyama, Mamoru Sekido, Hiroshi Takiguchi*

## Abstract

The Data Center at National Institute of Information and Communications Technology (NICT) archives and releases the databases and analysis results processed at the Correlation Center and the Analysis Center at NICT. Regular VLBI sessions with the Key Stone Project VLBI Network were the primary objective of the Data Center. These regular sessions continued until the end of November 2001. In addition to the Key Stone Project VLBI sessions, NICT has been conducting geodetic VLBI sessions for various purposes, and these data are also archived and released by the Data Center.

## 1. Introduction

In April 2004, the Communications Research Laboratory was integrated with the Telecommunications Advanced Organization of Japan (TAO) to establish the National Institute of Information and Communications Technology (NICT) as a new institute. The IVS Data Center at NICT archives and releases the databases and analysis results processed by the Correlation Center and Analysis Center at NICT. Major parts of the data are from the Key Stone Project (KSP) VLBI sessions [1], but other regional and international VLBI sessions conducted by NICT are also archived and released. Since routine observations of the KSP network terminated at the end of November 2001, there have been no additional data for the KSP regular sessions since 2002. In 2008, a series of geodetic VLBI sessions were carried out using the Kashima 34 m, Kashima 11 m, and Koganei 11 m stations to demonstrate precise time comparison. A series of astronomical VLBI sessions were carried out between the Kashima 34 m and Koganei 11 m stations to monitor the flux densities of radio variable stars using real-time e-VLBI data transfer and processing. The analysis results are available on the WWW server in the SINEX (Solution Independent Exchange) file format as well as other formats. Database files generated in the Mark III database file format are available upon request and will be sent to users on DDS tape cartridges. Database files of non-KSP sessions, i.e. other domestic and international geodetic VLBI sessions, are also available on the WWW server. Table 1 lists the WWW server locations maintained by the Data Center at NICT. In the past, an FTP server was used to provide data files, but it was decided to terminate the FTP service because of security risks of maintaining an anonymous FTP server. Instead, the [www3.nict.go.jp](http://www3.nict.go.jp) WWW server was prepared to hold large size data files.

Table 1. URL of the WWW server systems.

Service	URL
KSP WWW pages	<a href="http://ksp.nict.go.jp/">http://ksp.nict.go.jp/</a>
IVS WWW mirror pages	<a href="http://ivs.nict.go.jp/mirror/">http://ivs.nict.go.jp/mirror/</a>
Database files	<a href="http://www3.nict.go.jp/w/w114/stsi/database/">http://www3.nict.go.jp/w/w114/stsi/database/</a>
e-VLBI sessions	<a href="http://www.nict.go.jp/w/w114/stsi/research/e-VLBI/UT1/">http://www.nict.go.jp/w/w114/stsi/research/e-VLBI/UT1/</a>
Hayabusa sessions	<a href="http://www.nict.go.jp/w/w114/stsi/research/Navi/HAYABUSA/">http://www.nict.go.jp/w/w114/stsi/research/Navi/HAYABUSA/</a>

The responsibilities for the maintenance of these server machines were moved from the VLBI

research group of NICT to the common division for the institutional network service of the laboratory in 2001 to improve the network security of these systems.

## 2. Data Products

### 2.1. KSP VLBI Sessions

The KSP VLBI sessions were performed with four KSP IVS Network Stations at Kashima, Koganei, Miura, and Tateyama once a day or once every two days until May 1999. The high-speed ATM (Asynchronous Transfer Mode) network line to the Miura station became unavailable in May 1999, and real-time VLBI observations with the Miura station became impossible. Thereafter, the real-time VLBI sessions were performed with the other three stations. Once every six days (every third session), the observed data were recorded to the K4 data recorders at the three stations, and the Miura station participated in the sessions with the tape-based VLBI technique. In this case, the observed data at Kashima, Koganei, and Tateyama were processed in real-time, and the analysis results were released promptly after the observations completed. A day later, the observed tapes were transported from the Kashima, Miura, and Tateyama stations to the Koganei station for tape-based correlation processing of the full set of six baselines. After the tape-based correlation processing was completed, the data set produced with the real-time VLBI data processing was replaced by the new data set.

In July 2000, unusual site motion of the Tateyama station was detected from the KSP VLBI data series, and the frequency of the sessions was increased from once every two days to daily on July 22, 2000. The daily sessions were continued until November 11, 2000, and the site motions of the Tateyama and Miura stations were monitored in detail. During the period, it was found that the Tateyama station moved about 5 cm to the northeast. The Miura station also moved about 3 cm to the north. The unusual site motions of these two stations gradually settled, and the current site velocities seem to be almost the same as the site velocities before June 2000. Investigation of the time series of the site positions shows that the unusual site motion started sometime between the end of June 2000 and the beginning of July 2000. At the same time, volcanic and seismic activities near the Miyakejima and Kozushima Islands began. These activities are believed to have caused the regional crustal deformation in the area, explaining the unusual site motions at Tateyama and Miura.

### 2.2. Other VLBI Sessions

In addition to the regular KSP VLBI sessions, domestic and international geodetic and astronomical VLBI sessions were conducted by NICT in cooperation with Geographical Survey Institute (GSI), National Astronomical Observatory (NAO), and other organizations. These sessions are listed in Table 2. The observed data of these sessions were correlated by using the K4 correlator and the K5 software correlator at NICT either at Koganei or at Kashima or by using a real-time hardware correlator developed by NAO.

In 2008, 90 geodetic VLBI sessions were performed in total. Ultra-rapid e-VLBI sessions were performed based on the proposal submitted to and approved by the IVS Observing Program Committee in May 2007. The purpose of these sessions is to demonstrate e-VLBI capabilities for ultra-rapid data processing after Intensive type, short period (typically 1 hour) sessions. Observed data at one site are transferred to the other site in real-time by using high speed research networks,

Table 2. Geodetic VLBI sessions conducted by NICT (since 2005)

Year	Exp. Categories	Sessions
2005	Geodetic	c0505 (CONT05, partial participation), GEX13
	Hayabusa	14 sessions
2006	Geodetic	GEX14, viepr2, CARAVAN (3 sessions)
	Spacecraft	Geotail: 1 session
	Pulsar	1 session
2007	Ultra Rapid e-VLBI	15 times, 29 sessions
	Time Comparison	4 sessions, 12 days in total
	Cs-Gass-Cell	1 session
	Spacecraft	Hayabusa: 1 session
2008	Ultra Rapid e-VLBI	8 times, 33 sessions
	Time Comparison	26 sessions
	Variable Star e-VLBI	31 sessions

and the format conversion and data correlation processing are done immediately after the real-time file transfer. Thus, generation of the database with a minimum time of latency after each session is expected. Two stations in Japan, Tsukuba and Kashima, and two stations in Europe, Onsala and Metsähovi, are the regularly participating stations, and the Wettzell station will participate when regular IVS Intensive (INT2) sessions are used for the project. Within the project, we are developing the necessary software programs to realize real-time and near real-time data processing and automated data analysis. Our goal is to release the database file on the data center WWW server as soon as possible, as well as to release the analyzed results to the wide community by using e-mail. For this purpose, 33 sessions were scheduled over 8 days. The number of sessions performed for each day varied because of different reasons. Sometimes, only two sessions were scheduled and performed (e.g., on April 22), whereas 6 sessions were scheduled and performed on February 21, July 7, and July 11, 2008.

A series of time transfer sessions were also performed in 2008. The purpose of the sessions was to evaluate the capacity of geodetic VLBI experiments for precise and accurate time transfer between Time and Frequency Laboratories located worldwide.

In March 2008, the network connection between the Kashima and Koganei sites was upgraded from a mixture of ATM and IP connections over the OC192 network to a pure IP connection over the 10GbE network. To utilize the capabilities of the 10GbE network, a newly developed network interface unit from the National Astronomical Observatory (NAO) was installed at both the Kashima 34 m and the Koganei 11 m stations. Four ADS1000 high speed VSI-H A/D sampler units were connected to the interface units at each site, and it became possible to perform real-time e-VLBI observations between these two stations at the maximum data rate of 8 Gbps (1024 Msps, 2 bits/sample, 4 channels). From May 2008 to August 2008, a series of astronomical VLBI sessions were performed to monitor the flux density of radio variable stars at S-band and X-band.

Figure 1 shows the number of geodetic and astronomical VLBI sessions and the number of valid observed delays used in the data analysis for each year up to the year 2008.

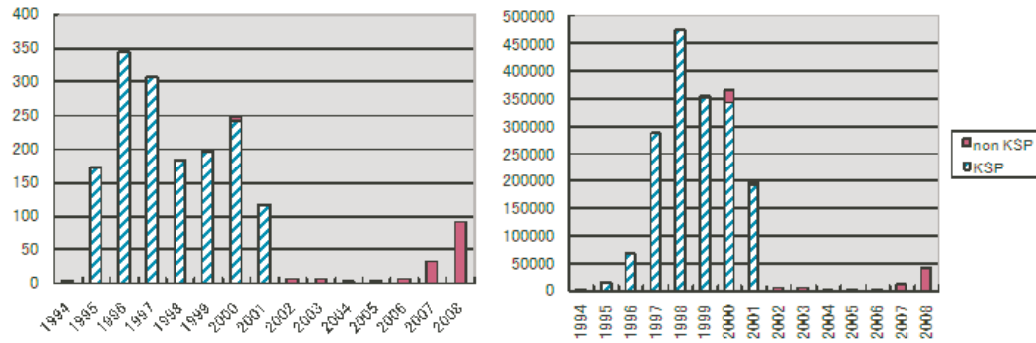

Figure 1. Number of sessions (left) and observed delays (right) used in the data analysis.

### 3. Staff Members

The data center at NICT is operated and maintained by the Space-Time Standards Group at Kashima Space Research Center, NICT. The staff members are listed in Table 3.

Table 3. Staff members of Space-Time Standards Group, KSRC, NICT

Name	Main Responsibilities
KOYAMA Yasuhiro	Administration of Data Servers
SEKIDO Mamoru	Responsible for e-VLBI sessions
TAKIGUCHI Hiroshi	Time Transfer
HASEGAWA Shingo	System Engineer

### 4. Future Plans

Although the regular VLBI sessions with the KSP VLBI network finished in 2001, the IVS Data Center at NICT will continue its service and will archive and release the analysis results accumulated by the Correlation Center and Analysis Center at NICT. In addition, a number of VLBI sessions will be conducted for the purposes of various technology developments.

### References

- [1] Special issue for the Key Stone Project, J. Commun. Res. Lab., Vol. 46, No. 1, March 1999.
- [2] Koyama, Y., T. Kondo, M. Kimura, and H. Takeuchi, IVS NICT TDC News, No. 26, Sep. 2005, pp. 9-12.

# Paris Observatory (OPAR) Data Center

*Christophe Barache*

## Abstract

This report summarizes the OPAR Data Center activities in 2008. Included is information about functions, architecture, status, future plans, and staff members of OPAR Data Center.

## 1. OPAR Data Center Functions

The Paris Observatory (OPAR) has provided a Data Center for the International VLBI Service for Geodesy and Astrometry (IVS) since 1999. The OPAR as well as CDDIS and BKG is one of the three IVS Primary Data Centers. Their activities are done in close collaboration for the purposes of collecting files (data and analysis files), and making them available to the community as soon as they are submitted.

The three data centers have a common protocol and each of them:

- has the same directory structure (with the same control file),
- has the same script,
- is able to receive all IVS files (auxiliary, database, products, documents),
- mirrors the other ones every three hours,
- gives free FTP access to the files.

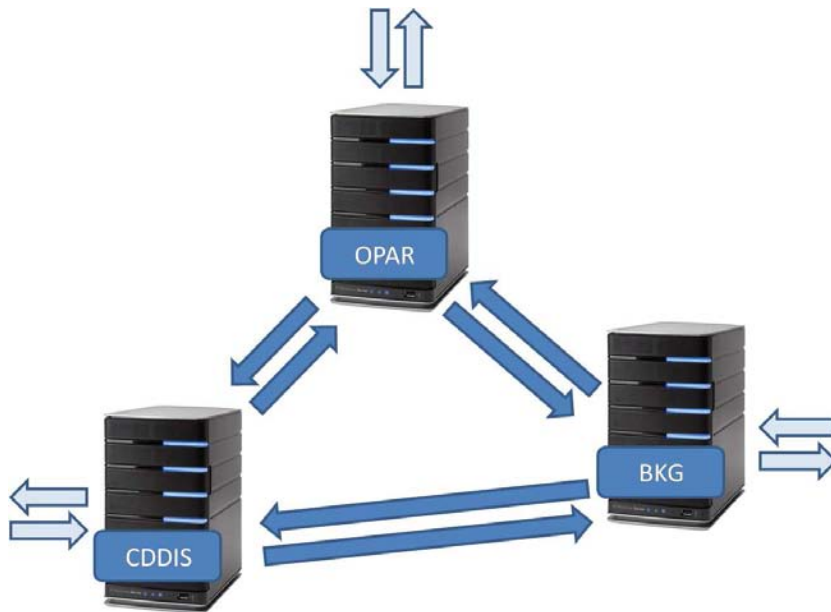

This protocol gives the IVS community transparent access to each data center through the same directory, and permanent access to files in case of a data center breakdown.

## 2. Architecture

To be able to put a file in a Data Center, operational and analysis centers have to be registered by the IVS Coordinating Center. The file names have to conform to the name conventions. A script checks the file and puts it in the right directory. For the OPAR Data Center submission procedure, the total number of failures is less than 10 per year; half are files downloaded by mistake, and the others are file naming errors. The script undergoes permanent improvement and takes into account the IVS components' requests.

The structure of the IVS Data Centers is:

```

ivscontrol/           : provides the control files needed by the data center
                       (session code, station code, solution code...)
ivscontrol_new/      : temporary test directory
ivscontrol_old/      : temporary test directory
ivsdocuments/        : provides documents and descriptions about IVS products
ivsdata/             : provides files related to the observations:
  aux/               : auxiliary files (schedule, log...)
  db/                : observation files in database CALC format
  ngs/               : observation files in NGS format
  sinex/             : observation files in SINEX format
ivsproducts/         : provides results from Analysis Centers:
  eopi/              : Earth Orientation Parameters, intensive sessions
  eops/              : Earth Orientation Parameters, 24h sessions
  crf/               : Celestial Reference Frame
  trf/               : Terrestrial Reference Frame
  daily_sinex/       : Time series solutions in SINEX format of Earth
                       orientation and site positions
  int_sinex/         : Daily Intensive solutions in SINEX format, mainly
                       designed for combination
  trop/              : Tropospheric time series (starting July 2003)
ivs-iers/            : provides products for IERS Annual Report
ivs-pilot2000/        : provides products of 2000 for special investigations
ivs-pilot2001/        : provides products of 2001 for special investigations
ivs-pilottro/        : provides tropospheric time series for Pilot Project
                       (until June 2003)
ivs-pilotbl/         : provides baseline files
ivs-special/         : specific studies
raw/                 : original data (not writable at OPAR Data Center)

```

## 3. Current Status

The OPAR Data Center is operated on a PC Server (PowerEdge 2800 — Xeron 3.0 GHz) located at the Paris Observatory and running the Fedora Linux operating system. To make all IVS products available on-line, the disk storage capacity was significantly increased, and the server is equipped now with a RAID 3 TB disk extensible up to 4.7 TB.

The OPAR server is accessible 24 hours per day, seven days per week through Internet connection with a 2 Mbit/s rate. Users can get the IVS products by using the FTP protocol. Access to this server is free for users.

FTP access:

```
ivsopar.obspm.fr
username: anonymous
password: your e-mail
cd vlbi (IVS directory)
```

#### 4. Future Plans

The OPAR staff will continue to work with the IVS community and in close collaboration with the two other Primary Data Centers in order to provide public access to all VLBI related data. We'll soon provide more statistical information about access to the OPAR Data Center.

#### 5. Staff Members

Staff members who are contributing to the OPAR Data Center and Analysis Center for IVS are listed below:

- Christophe Barache, Data Center manager and Data Analysis.
- Anne-Marie Gontier, responsible for GLORIA Analysis Software.
- Sébastien Lambert, scientific developments.
- Daniel Gambis, interface with IERS activities.

To obtain information about the OPAR Data Center, please contact: [ivs.opa@obspm.fr](mailto:ivs.opa@obspm.fr)





**Analysis Centers**

**Analysis Centers**



# Analysis Center of Saint Petersburg University

*Veniamin Vityazev, Dmitriy Trofimov, Maria Kudryashova*

## Abstract

This report briefly summarizes the activities of the Analysis Center of Saint Petersburg University during 2008. Changes which happened in our solutions and staff, as well as our future plans, are described.

## 1. Introduction

The Sobolev Astronomical Institute is located in Petrodvorets, near Saint Petersburg. It is a research institute of the Saint Petersburg State University. In 1998 the Analysis Center of Saint Petersburg University was established in the Institute. Due to the staff changes in 2007 we had a gap in our submissions for IVS that year. The main activity of the SPU AC for the International VLBI Service before 2007 consisted of routine processing of 24-hour and 1-hour observational sessions for obtaining Earth Orientation Parameters (EOP) and rapid UT1-UTC values respectively. In 2008 we resumed submitting results of 24-hour session processing. During 2008 the activities of the SPU AC were supported by the Ministry of Education and Science of the Russian Federation (grant 2.1.1.5077).

## 2. Staff

Starting in 2008 a new member has become involved in the current processing of VLBI observations: a Ph.D. student of Saint Petersburg University, Dmitriy Trofimov. The person previously responsible for routine work — Maria Kudryashova — was temporarily involved in the work of the SPU AC in the middle of 2008. General coordination and support for the activities of the SPU AC at the Astronomical Institute was performed by Prof. Veniamin Vityazev.

## 3. Activities in 2008

- This year we resumed the operation of our center. Only routine estimation of the five Earth Orientation Parameters was performed. The OCCAM package software (version 6\_2) was used for current processing of VLBI data [1]. In contrast to the previous versions of the same package, all the reductions are made in the system of the mean equinox. Matrices of partial derivatives have been defined more accurately in this version as well. Due to the above mentioned changes in the procedure of EOP estimation, a whole series of EOP has been re-processed. The new time series is named spu00004.eops. It includes data obtained by the IRIS-A, NEOS-A, R1, and R4 observing programs, and it covers a 20 year period (from January 2, 1989 until the end of 2008). The total number of processed experiments is about 1400.
- All parameters have been adjusted using the Kalman filter technique. For all stations (except the reference one), the wet delay, clock offsets, clock rates, and troposphere gradients were estimated. Troposphere wet delay and clock offsets were modeled as a stochastic process

such as a random walk. The clock rates and the troposphere gradients were considered to be the constant parameters.

- The main details of the preparation of the EOP time series spu00004.eops are summarized below:
  - Data span: 1989.01–2008.12
  - CRF: fixed to ICRF-Ext.2
  - TRF: VTRF2005 was used as an a priori TRF
  - Estimated parameters:
    1. EOP:  $x, y, UT1 - UTC, d\psi, d\varepsilon$ ;
    2. troposphere: troposphere gradients were estimated as constant parameters, and wet troposphere delays were modeled as a random walk process;
    3. station clocks were treated as follows: offset as a random walk process, rate as a constant.
  - nutation model: IAU 1980
  - mapping function: VMF1
  - technique: Kalman filter
  - software: OCCAM v.6\_2

#### 4. Future Plans

In 2009 we plan to continue our regular work. Besides production of scientific data, we are going to include the practical work on deriving EOP from VLBI observations in the systematic curriculum of a special course on radio astronomy.

#### References

- [1] O. Titov, V. Tesmer, J. Boehm, OCCAM v. 6. 0 Software for VLBI Data Analysis, In International VLBI Service for Geodesy and Astrometry 2004 General Meeting Proceedings, N. R. Vandenberg and K. D. Baver (eds.), NASA/CP-2004-212255, pp.267-271, 2004.

# Geoscience Australia Analysis Center

*Oleg Titov*

## Abstract

This report gives an overview about the activities of the Geoscience Australia IVS Analysis Center during 2008.

## 1. General Information

The Geoscience Australia (GA) IVS Analysis Center is located in Canberra. The Geodesy group operates as a part of the Geospatial and Earth Monitoring Division (GEMD).

## 2. Component Description

Currently the GA IVS Analysis Center contributes nutation offsets, EOP, and EOP rates on a regular basis for IVS-R1 and IVS-R4 networks and their predecessors (IRIS-A and NEOS-A). The EOP time series are available for 1983 to 2008. The CRF catalogues using a global set of VLBI data since 1979 are regularly submitted.

## 3. Staff

- Dr. Oleg Titov - project manager

## 4. Current Status and Activities

Several CRF solutions have been prepared using the OCCAM 6.2 software. VLBI data comprising 3,700 daily sessions from 25-Nov-1979 to 04-Sep-2008 have been used to compute several global solutions with different sets of reference radio sources. This includes 4,279,473 observational delays from 2,066 radio sources observed by 60 VLBI stations. The dipole and quadrupole systematic effects in apparent proper motion of the reference radio sources (magnitude about 20 microarcsec/year) were indicated [1].

Station coordinates were also estimated using NNR and NNT constraints. The long-term time series of the station coordinates have been established to estimate the corresponding velocities for each station. Due to a limited amount of observations the velocities have been estimated for 55 stations only. The velocities of five stations—DSS65A, MARKUS, METSAHOV, VLBA85 3, and BADARY—were not estimated. The tectonic motion for the Gilcreek VLBI site after the Denali earthquake was modelled using an exponential function [2].

The adjustment has been done by least squares collocation [3], which considers the clock offsets, wet troposphere delays, and troposphere gradients as stochastic parameters with a priori covariance functions. The gradient covariance functions were estimated from GPS hourly values [4].

## 5. Geodetic Activity of the Australian Radiotelescopes

During 2008 two Australian radiotelescopes—Hobart and Parkes, operated by the University of Tasmania (UTAS) and Australia Telescope National Facility (ATNF), respectively—were involved in geodetic VLBI observations. GA's Geodesy Group supported the observations in different ways including assistance with campaign scheduling.

The Parkes 64-meter telescope participated in six geodetic VLBI sessions in 2008 (CRF-52, T2055, APSG-22, CRF-54, APSG-23, and OHIG-60). All of them were recorded with Mark 5B. Five sessions are planned for 2009 for further improvement of the ITRF and the ICRF in the Southern Hemisphere. This program is undertaken in cooperation with ATNF and UTAS.



Figure 1. Local visitors touring the Parkes radiotelescope site during the OHIG60 geodetic VLBI session. The 12-meter 'Patriot' dish installed at Parkes for technical tests is visible in the background.

## 6. New Geodetic VLBI Network

Geoscience Australia supported the installation work of the new Australian geodetic VLBI network during 2008. The first telescope in Hobart is expected to be installed in April/May of 2009 and to start operations by the end of 2009. Two other telescopes (Yarragadee, Western Australia and Katherine, Northern Territory) will be built in 2009–2010. The radio astronomy group at UTAS has responsibility for the network deployment. In addition, the 12-meter New

Zealand radiotelescope near Auckland was installed [5].

## References

- [1] Titov, O., Systematic Effects in Apparent Proper Motion of Radio Sources, In: “Measuring the Future”, International VLBI Service for Geodesy and Astrometry 2008 General Meeting Proceedings, Institute of Applied Astronomy, St. Petersburg, A. Finkelstein and D. Behrend (eds.), 265–269, 2008, (arXiv:0805.1099v1 [astro-ph]).
- [2] Titov, O., P. Tregoning, Post-seismic motion of the Gilcreek geodetic sites following the November, 2002 Denali Earthquake, In: International VLBI Service for Geodesy and Astrometry 2004 General Meeting Proceedings, NASA/CP-2004-212255, N. R. Vandenberg and K. D. Baver (eds.), 496–500, 2004.
- [3] Titov, O., Estimation of subdiurnal tidal terms in UT1-UTC from VLBI data analysis, In: IERS Technical Notes 28, B. Kolaczek, H. Schuh, and D. Gambis (eds.), 11–14, 2000.
- [4] Haas, R., private communication.
- [5] Titov, O., S. Gulyaev, J. Lovell, J. Dickey, Australian – New Zealand Geodetic VLBI Network Project, In: “Measuring the Future”, International VLBI Service for Geodesy and Astrometry 2008 General Meeting Proceedings, Institute of Applied Astronomy, St. Petersburg, A. Finkelstein and D. Behrend (eds.), 114–118, 2008.

# Bordeaux Observatory Analysis Center Report

*Patrick Charlot, Antoine Bellanger, Géraldine Bourda, Arnaud Collioud, Ming Zhang,  
Alain Baudry*

## Abstract

This report summarizes the activities of the Bordeaux Observatory Analysis Center in 2008. During this period, we continued our VLBI imaging activity and produced a total of 581 VLBI maps by processing three RDV sessions. Structure indices and source compactness were derived from these images to assess the astrometric source quality. A pipeline is also being developed to model-fit the VLBI structures in an automatic way and extract relevant physical information for astrophysics. Other activities focused on regular analysis of the IVS-R1 and IVS-R4 sessions and simulations to study the imaging capabilities of the next generation VLBI system. On the observational side, we further pursued our project to identify new reference frame sources for the link with the future Gaia frame, and we imaged 105 weak candidate sources for this link. Plans for 2009 follow the same analysis and research lines.

## 1. General Information

The Bordeaux Observatory is located in Floirac, near the city of Bordeaux, in the southwest of France. It is funded by the University of Bordeaux and the CNRS (National Center for Scientific Research). VLBI analysis and research activities are primarily developed within the M2A group (“Métrologie de l’espace, Astrodynamique, Astrophysique”).

The contribution of Bordeaux Observatory to IVS has been mostly concerned with the maintenance, extension, and improvement of the International Celestial Reference Frame (ICRF). This includes regular VLBI imaging of the ICRF sources and evaluation of their astrometric suitability, as well as developing specific VLBI observing programs for reference frame applications.

In addition, the group is in charge of the VLBI component in the multi-technique GINS software package [1, 2] as part of a collaborative effort within the French “Groupe de Recherches de Géodésie Spatiale” (GRGS) to combine VLBI and space geodetic data (SLR, GPS, DORIS) at the observation level. This effort also involves space geodesy groups in Toulouse, Grasse, and Paris.

## 2. Description of Analysis Center

The Bordeaux Observatory Analysis Center routinely analyzes the weekly IVS-R1 and IVS-R4 sessions by using the GINS software package. Current work in this area includes the testing of the recently released Linux version of GINS (GINS-PC) and the development of operational procedures. In addition, specific solutions targeted to the construction of the ITRF2008 have been produced in the framework of the GRGS multi-technique combination at the observation level.

Another activity is focused on producing VLBI maps of the ICRF sources by analysis of data from the RDV sessions. This analysis is conducted with the AIPS and DIFMAP calibration and imaging software packages. The aim of such regular imaging is to characterize the astrometric suitability of the sources based on the so-called “structure index”, and to compare source structural evolution and positional instabilities. Such studies are especially important in the framework of the ongoing work for the realization of the next ICRF by a joint IAU/IVS/IERS working group.

The Bordeaux group is also involved in the VLBI2010 activities and as such was tasked to



develop simulations of source structure maps to evaluate the imaging capabilities of the next generation VLBI system and its potential for modeling source structural effects on a routine basis.

### 3. Scientific Staff

The IVS group in Bordeaux comprises the following six individuals who are involved either part-time or full-time in VLBI analysis and research activities, as described below:

- Patrick Charlot (20%): overall responsibility for Analysis Center work and data processing. His research interests include the ICRF densification, extension, and link to the Gaia frame; studies of source structure effects in astrometric VLBI data, and astrophysical interpretation.
- Antoine Bellanger (80%): engineer with background in statistics and computer science. His main role is to conduct initial VLBI data processing and to develop analysis tools as needed. He is also the Web master for the M2A group.
- Géraldine Bourda (40%): post-doc fellow funded by the French space agency (CNES). She is in charge of the VLBI analysis with GINS for combining space geodesy data at the observation level. She also leads an observational program for linking the ICRF and the Gaia frame.
- Arnaud Collioud (100%): engineer with background in astronomy and interferometry. His tasks are to process the RDV sessions with AIPS and DIFMAP to image the sources, to maintain the Bordeaux VLBI Image Database (BVID), and to develop VLBI2010 simulations.
- Ming Zhang (20%): post-doc fellow funded by the CNRS (in the group since October 2008). His work is targeted towards finding automatic ways to model-fit VLBI structures and extract physical information with the aim of studying the evolution of the sources from the BVID.
- Alain Baudry (10%): radioastronomy expert with specific interest in radio source imaging and astrometric VLBI.

### 4. Analysis and Research Activities during 2008

As noted above, a significant portion of our activity consists of imaging the sources observed during the RDV sessions on a systematic basis. During the past year, three such sessions were processed (RDV66, RDV68, and RDV70), resulting in 581 VLBI images at either X or S band for 215 different extragalactic sources. The imaging work load has been shared between USNO and Bordeaux Observatory since 2007 (starting with RDV61): the USNO group processes the odd-numbered RDV sessions while the Bordeaux group processes the even-numbered ones.

The VLBI images are used to derive structure correction maps and visibility maps along with values for structure indices and source compactness (see [3, 4] for a definition of these quantities). These indicators are useful for categorizing the sources according to their structures and identifying those that have the highest astrometric quality (e.g. for defining the next ICRF). All such information is made available through the recently-opened Bordeaux VLBI Image Database (BVID)<sup>1</sup>. At present, the BVID comprises a total of 1530 VLBI images (with links to an additional 6820 VLBI images from the Radio Reference Frame Image Database (RRFID) of the USNO, at either S, X, K or Q band) along with 8350 structure correction maps and as many visibility maps.

---

<sup>1</sup>The BVID may be accessed at <http://www.obs.u-bordeaux1.fr/BVID>

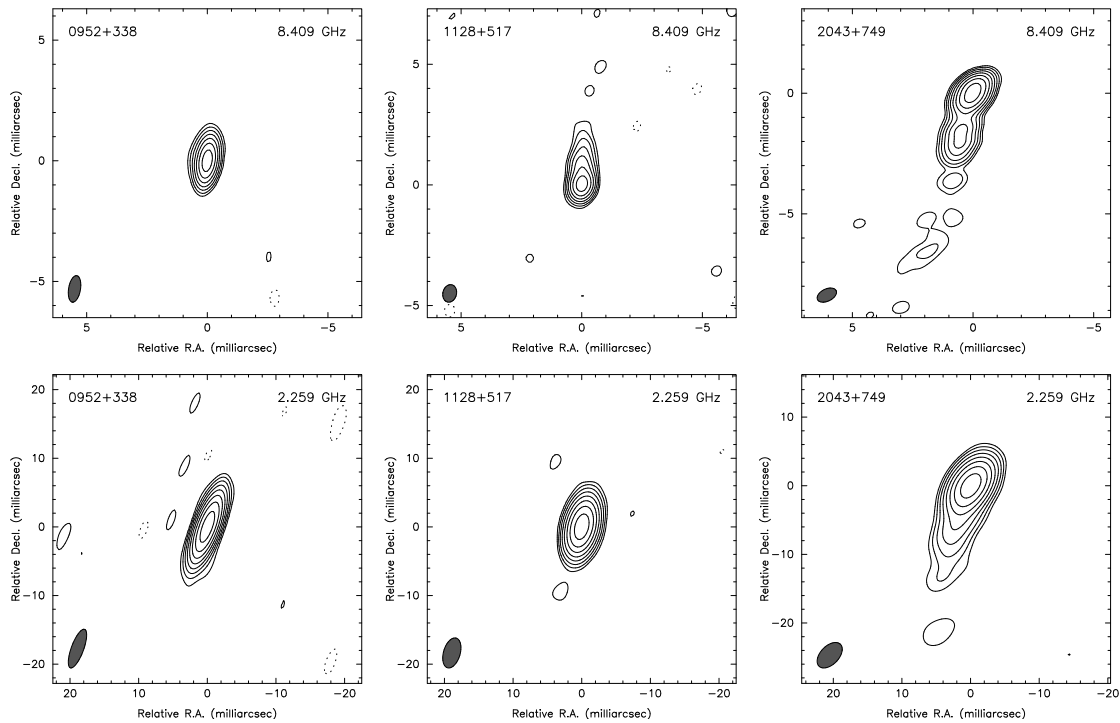

Figure 1. VLBI images of three candidate sources for linking the ICRF and the future Gaia frame. The total flux density of these sources is 50, 37, and 181 mJy at X band (upper panels) and 72, 114, and 202 mJy at S band (lower panels). Contour levels in the images are drawn from 0.5% or 1% of the peak brightness.

Additional work aimed at studying the evolution of these structures over time was also recently initiated to exploit the BVID for astrophysics. For this purpose, a pipeline is being developed to model-fit VLBI structures in an automatic way and extract physical information. Initial results show that the program works out fairly well for simple VLBI structures, but for extended or complicated structures, the fitted models could be degenerate or erroneous, thereby still requiring manual care. Despite this limitation, it is anticipated that this pipeline, when fully operational, should save a lot of time in the modeling of the thousands of VLBI structures contained in the BVID.

During the past year, our multi-stage VLBI observational program to identify and characterize new sources to link the ICRF and the future Gaia frame was also pursued further. As reported in [5], we detected 398 candidate sources for this link based on initial observations with the European VLBI Network (EVN). The second stage of the program, aimed at imaging these sources, began in March 2008 with an observation of 105 candidates using a 16-station network combining the EVN and the Very Long Baseline Array. All 105 sources have been successfully imaged from these data, a large portion of which show compact structures suitable for precise astrometry (see Fig. 1 for a sample of images). Future steps will consist of imaging the remainder of these sources and determining accurate astrometric positions for the most promising candidates.

Studies of the imaging capabilities of the VLBI2010 system continued during 2008 with focus on weaker sources to supplement the results previously obtained for high-SNR sources [6]. The simulations for both weak and strong sources demonstrate that the standard hypothetical 16-

station network of the VLBI2010 system is generally well-suited to producing high-quality images but fails to recover extended structures for far south sources due to the lack of short baselines in the Southern Hemisphere. Further tests showed that adding two stations at carefully selected locations mitigates that problem and improves the recovery of extended structures, giving simulated images at southern declinations that have a quality comparable to those for northern sources.

## 5. Outlook

For the year 2009, our plans include the following:

- Keep on analyzing the new IVS-R1 and IVS-R4 sessions as they become available and move towards operational analysis with GINS.
- Continue the processing of the RDV sessions in cooperation with USNO to monitor the X- and S-band structural variability of the ICRF sources and evaluate their astrometric suitability based on the structure index and source compactness criteria.
- Make our new source maps, structure correction maps, structure index and source compactness indicators available through the Bordeaux VLBI Image Database (BVID).
- Finalize the pipeline to model-fit VLBI structures in an automatic way and start massive processing of the BVID data with this pipeline.
- Contribute to the realization of the next ICRF, focusing on the selection of defining sources and the identification of unstable sources from the structural information in the BVID.
- Pursue further our VLBI observational program to identify and characterize new sources to link the ICRF and the future Gaia optical frame.
- Generate structure correction maps from simulated VLBI2010 images and assess the accuracy of the structural corrections derived from these images.

## References

- [1] Meyer, U., Charlot, P., Biancale, R.: 2000, GINS: A New Multi-technique Software for VLBI Analysis, IVS 2000 General Meeting Proceedings, Eds. N. R. Vandenberg and K. D. Baver, NASA/CP-2000-209893, p. 324–328.
- [2] Bourda, G., Charlot, P., Biancale, R.: 2007, GINS: A New Tool for VLBI Geodesy and Astrometry, Proceedings of the 18th European VLBI for Geodesy and Astrometry Working Meeting, Eds. J. Böhm, A. Pany, and H. Schuh, IGG Vienna, p. 59–63.
- [3] Fey, A. L., Charlot, P.: 1997, VLBA Observations of Radio Reference Frame Sources. II. Astrometric Suitability Based on Observed Structure, *ApJS*, 111, 95–142.
- [4] Charlot, P.: 2008, Astrophysical Stability of Radio Sources and Implication for the Realization of the Next ICRF, 5th IVS General Meeting Proceedings, St Petersburg (Nauka), Eds. A. Finkelstein and D. Behrend, p. 345–354.
- [5] Bourda, G., Charlot, P., Porcas, R., Garrington, S.: 2008, Multi-Step VLBI Observations of Weak Extragalactic Radio Sources to Align the ICRF and the Future GAIA Frame, 5th IVS General Meeting Proceedings, St Petersburg (Nauka), Eds. A. Finkelstein and D. Behrend, p. 25–29.
- [6] Collioud, A., Charlot, P.: 2008, Imaging Capabilities of the Next Generation VLBI System, 5th IVS General Meeting Proceedings, St Petersburg (Nauka), Eds. A. Finkelstein and D. Behrend, p. 433–438.

# BKG/DGFI Combination Center Annual Report 2008

*Wolfgang Schwegmann, Michael Gerstl, Robert Heinkelmann*

## Abstract

This report summarizes the activities of the BKG/DGFI Combination Center in 2008 and outlines the planned activities for the year 2009.

## 1. General Information

The BKG/DGFI Combination Center has been established jointly by the Federal Agency for Cartography and Geodesy (Bundesamt für Kartographie und Geodäsie, BKG) and the German Geodetic Research Institute (Deutsches Geodätisches Forschungsinstitut, DGFI). BKG is a German federal authority assigned to the Federal Ministry of the Interior. Its tasks include, among others, the provision of geodetic reference data and basic spatial data for the needs of the Federal Government—the administrative, economic, and scientific sectors—as well as for the citizens. DGFI is an autonomous and independent research institution located in Munich. It is run by the German Geodetic Commission (Deutsche Geodätische Kommission, DGK) at the Bavarian Academy of Sciences. The research covers all fields of geodesy and includes the participation in national and international projects as well as functions in international bodies.

The joint BKG/DGFI Combination Center was inaugurated by the IVS Directing Board in October 2008. The tasks of this IVS Combination Center include quality control and a timely combination of the session-based intermediate results of the IVS Analysis Centers into a final combination product (e.g., Earth Orientation Parameters, EOP). After consultation with the IVS Analysis Coordinator, the combination results will be released as official IVS products. The Combination Center is also expected to contribute to the generation of the official IVS input to any ITRF activities. These tasks should be performed on an operational basis.

## 2. Component Description

The BKG/DGFI Combination Center will perform a combination of session-based results of the IVS Analysis Centers on an operational basis. The strategy for the combination will be adapted from the combination process currently done by the IVS Analysis Coordinator as described in [1]. Combination will be done for the two IVS EOP series (rapid and quarterly solutions) on the basis of datum-free normal equations in SINEX format.

According to the joint proposal, the following Combination Center functions will be performed at BKG:

- Ensure quality control of the Analysis Center results: Check the format of the results and their suitability for combination, perform identification and reduction of outliers, compare the Analysis Centers' results against each other and compare the results w.r.t. external time series, e.g. from IERS or IGS.
- Provide feedback to the Analysis Centers: Quality control results will be available at the BKG/DGFI IVS Combination Center Web page. If preferred by the Analysis Centers, the results will be provided by e-mail, too.

- Create high quality combination products and perform timely archiving and distribution: Combination products will be created using the DGFI DOGS software package, which operates by the combination of unconstrained (free) normal equations.
- Submit official IVS combination products to the IERS: The produced official IVS combination products will be submitted to the responsible IERS components as requested by the IERS. This will be supported by the staff of the IERS Central Bureau at BKG.
- Place final results in IVS Data Centers: Final results will be placed in the BKG Data Center. This will be assisted by the staff of the BKG Data Center in Leipzig.
- Generate official IVS input to the ITRF: Official IVS input to the ITRF will be created as combined weekly solutions in SINEX format.

DGFI will be in charge of the below-mentioned Combination Center functions:

- Develop state-of-the-art combination procedures: State-of-the-art combination procedures will be developed mainly at DGFI. This work, as well as the following item, is also related to DGFI's efforts as an IERS Combination Research Center and an IERS ITRS Combination Center.
- Perform software development and documentation: At DGFI the DOGS software package will be continuously updated by implementing the developed state-of-the-art combination procedures.
- Adhere to IERS Conventions: The DGFI DOGS software package is continuously updated to be as much as possible in accordance with the IERS Conventions.

### 3. Staff

The list of the staff members of the BKG/DGFI Combination Center is given in Table 1.

Table 1. Staff members of the BKG/DGFI Combination Center.

Name	Affiliation	Function	E-Mail
Michael Gerstl	DGFI	Software maintenance	gerstl@dgfi.badw.de
Robert Heinkelmann	DGFI	Combination strategies	heinkelmann@dgfi.badw.de
Alexander Lothhammer	BKG	Hardware maintenance	alexander.lothhammer@bkg.bund.de
Wolfgang Schwegmann	BKG	Combination	wolfgang.schwegmann@bkg.bund.de

### 4. Current Status and Activities

In June 2008 the IVS Directing Board solicited proposals for the installation and operation of IVS Combination Centers. The joint proposal of BKG and DGFI to become an IVS Combination

Center was accepted by the IVS Directing Board at the 20th Board meeting in Penticton, BC, Canada on September 13, 2008.

After inauguration of the joint BKG/DGFI Combination Center by a letter from the Chair of the Directing Board on October 21, 2008, the work for this new IVS component started. In 2008 the hardware to perform the analysis has been acquired and a first meeting with the IVS Analysis Coordinator has taken place on December 3, 2008. At this meeting the transition of the operational combination to the BKG/DGFI Combination Center in 2009 has been planned.

## 5. Plans for 2009

In 2009 BKG and DGFI will start the IVS Combination Center with the final goal to take over the operational combination of the session-based results of the IVS Analysis Centers from the IVS Analysis Coordinator. Following steps will be undertaken to reach this goal:

- Installation of DOGS Software and additional scripts for combination on dedicated hardware.
- Perform combination in parallel with the operational combinations done at the IVS Analysis Coordinators office.
- Compare results with those obtained in operational combination; discover and resolve problems.
- Take over operational combination tasks at latest October 1, 2009.

## References

- [1] Nothnagel, A., Böckmann, S., Artz, T., Analysis Coordinator Report, In: International VLBI Service for Geodesy and Astrometry 2007 Annual Report, NASA/TP-2008-214162, D. Behrend and K. D. Baver (eds.), 16–17, 2008.

# Matera CGS VLBI Analysis Center

*Roberto Lanotte, Giuseppe Bianco*

## Abstract

This paper reports the VLBI data analysis activities at the Space Geodesy Center (CGS) at Matera from January 2008 through December 2008 and the contributions that the CGS intends to provide for the future as an IVS Analysis Center.

## 1. General Information

The Matera VLBI station became operational at the Space Geodesy Center (CGS) of the Italian Space Agency (ASI) in May 1990. Since then it has been active in the framework of the most important international programs. VLBI data analysis activities are performed at CGS for a better understanding of the tectonic motions with specific regard for the European area. The CGS, operated by Telespazio on behalf of ASI, provides full scientific and operational support using the main space geodetic techniques: VLBI, SLR and GPS.

## 2. Staff at CGS contributing to the IVS Analysis Center

- Dr. Giuseppe Bianco, Responsible for CGS/ASI (primary scientific/technical contact).
- Dr. Cinzia Luceri, Responsible for scientific activities, e-GEOS.
- Dr. Roberto Lanotte, Geodynamics data analyst, Telespazio.

## 3. Current Status and Activities

### 3.1. Global VLBI Solution Asi2008a

The main VLBI data analysis activities at the CGS in the year 2008 were directed towards the realization of a global VLBI solution, named asi2008a, using the CALC/SOLVE software (developed at the GSFC). The main characteristics of this solution are:

- Data span:  
1979.08.03 - 2008.11.07 (3510 sessions)
- Estimated Parameters:
  - Celestial Frame:  
right ascension and declination as global parameters for 637 sources
  - Terrestrial Frame:  
Coordinates and velocities for 92 stations as global parameters
  - Earth Orientation:  
Unconstrained X pole, Y pole, UT1, Xp rate, Yp rate, UT1 rate, dpsi and deps.

### **3.2. IVS Tropospheric Products**

Regular submission of tropospheric parameters (wet and total zenith path delays, and east and north horizontal gradients) for all VLBI stations observing in the IVS R1 and R4 sessions was continued during 2008. At present 601 sessions have been analysed and submitted covering the period from 2002 to 2008. The results are available at the IVS products ftp sites.

### **3.3. IVS Product “Time Series of Baseline Lengths”**

Regular submission of station coordinate estimates, in SINEX files, was continued during 2008 for the IVS product “Time Series of Baseline Lengths”. This is composed of 3312 sessions, from 1979 to 2008.

## **4. Future Plans**

- Continue and improve the realization of global VLBI analysis.
- Continue to participate in IVS analysis projects.



# DGFI Analysis Center Annual Report 2008

*Manuela Seitz, Hermann Drewes, Volker Tesmer, Robert Heinkelmann*

## Abstract

This report summarizes the activities of the DGFI Analysis Center in 2008 and outlines the planned activities for 2009.

## 1. General Information

The German Geodetic Research Institute (Deutsches Geodätisches Forschungsinstitut, DGFI) is an autonomous and independent research institution located in Munich. It is run by the German Geodetic Commission (Deutsche Geodätische Kommission, DGK) at the Bavarian Academy of Sciences. The research covers all fields of geodesy and includes participation in national and international projects as well as functions in international bodies (see also <http://www.dgfi.badw.de>).

## 2. Activities in 2008

### 1. Homogeneously reprocessed VLBI and GPS height time series

Homogeneously reprocessed VLBI and GPS height series from 1994 to 2007 were compared. The data analysis used fully adapted state-of-the-art models (such as VMF1 and a priori zenith delays from ECMWF) for the GPS (at GFZ and at TUM with Bernese 5.1) and VLBI (at DGFI with OCCAM 6.1, LSM) processing. The series were compared in terms of long term non-linear behaviour and harmonic and mean annual signals (derived by averaging the positions of all years into one “mean year”). The mean annual signals are quite similar for VLBI and GPS (Figure 1), if the VLBI data is available with an appropriate density. The two almost independent observing techniques show the same mean annual signals at nearly all co-located sites. Therefore we assume that the annual signals can be geophysically interpreted as integral vertical deformations.

In order to study regional effects, the stations of one region (with a dimension of some thousand kilometers) with a similar mean annual signal are grouped into a cluster. Accordingly 55 clusters are defined. To illustrate the clusters, and how diverse the signals from clustered sites can be, the results for the European region are displayed in Figure 2. They confirm that the signals reflect regional deformations, not local or technical artifacts.

The most important findings from this study are that (1) for most sites, an annual harmonic function is not a sufficient approximation and that (2) the variations of station heights are regional effects and are induced by mass load variations.

For each of the 55 clusters, a regional average mean annual signal was computed. They can be used as a tool to validate geophysical models.

### 2. Atmospheric loading coefficients determined from homogeneously reprocessed GPS and VLBI time series

VLBI and GPS long term observation series were reprocessed at DGFI and TU Munich. (See above.) The processing was done twice, once with the classical tropospheric modeling (A:

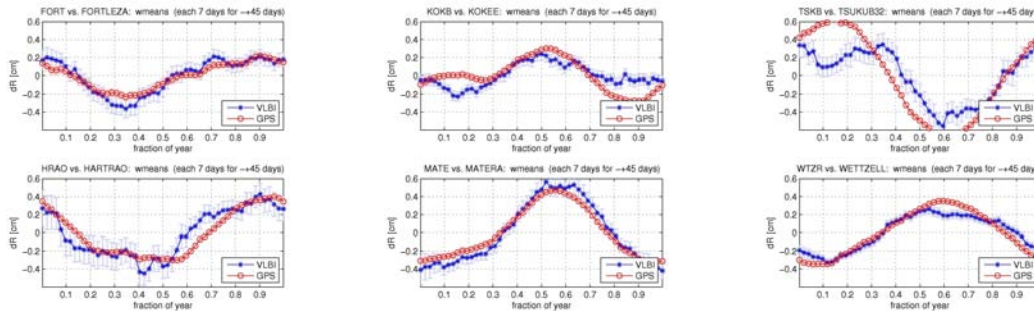

Figure 1. Mean annual behavior of homogeneously reprocessed VLBI (darker/blue asterisks) and GPS (lighter/red circles) height time series at co-located sites (column-wise, from left to right): a) Fortaleza (Brasil), b) Hartebeesthoek (South Africa), c) Kokee Park (Hawaii, USA), d) Matera (Italy), e) Tsukuba (Japan) and f) Wettzell (Germany).

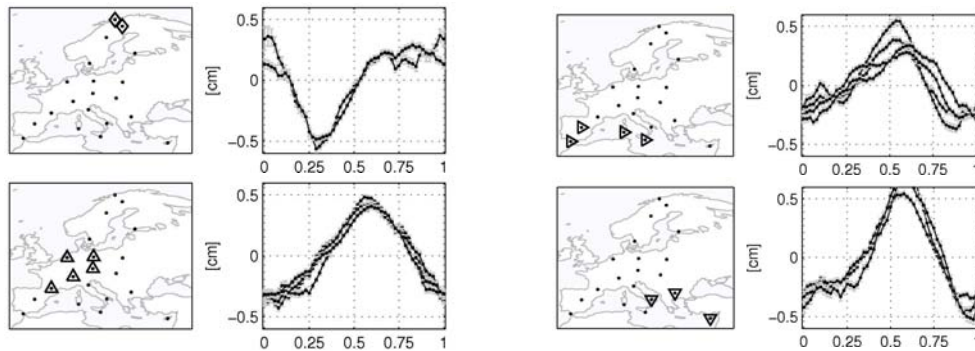

Figure 2. Mean annual signals for the defined four European clusters: a) KIRU, TROM, b) KOSG, POTS, TLSE, WTZR, ZIMM, c) CAGL, NOT1, SFER, YEBE, d) MATE, NICO, SOFI (up down, left right). The figures illustrate 50 days moving weighted means and their formal errors, computed each 7 days from the daily height estimates (weighted mean values removed).

NMF and constant a priori zenith delays) and once with advanced models (**B**: VMF1 and a priori zenith delays from ECMWF). Theoretically, station position time series resulting from approach **B** should display the atmospheric loading deformation better because shortcomings of both the mapping function and the constant a priori ZD of **A** induce parts of this signal to be absorbed by tropospheric parameters. In order to verify this effect, the height time series of GPS and VLBI stations were compared between **A** and **B**. The results were then used to investigate two questions:

Question 1: Can position time series be improved using state-of-the-art models?

Using approach **B**, the agreement of harmonic annual signals of homogeneous VLBI and GPS height series improves compared to approach **A**. (The WRMS of the VLBI–GPS differences of the harmonic annual signals are 2.2 mm for **A** and 1.8 mm for **B**.) This is significant for the atmospheric loading coefficients, which were estimated from these series using local ECMWF pressures and linear regression: the WRMS of the differences (GPS–VLBI) is 0.134 and 0.083 mm/mbar for **A** and for **B** respectively. See Figure 3. Additionally, the

agreement of the coefficients with those provided by GGFC (Global Geophysical Fluids Center, <http://www.ecgs.lu/ggfc>) improves significantly using **B**. The WRMS's of the VLBI–GGFC differences are 0.301 and 0.154 mm/mbar, and the WRMS's of the GPS–GGFC differences are 0.232 and 0.161 mm/mbar (for **A** and for **B**, respectively).

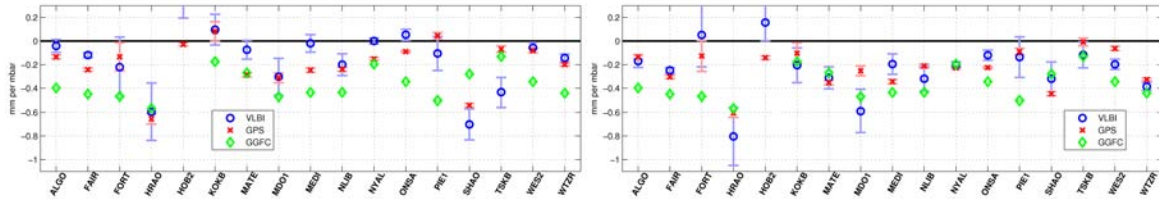

Figure 3. Atmospheric loading regression coefficients and their formal errors, determined from VLBI- (blue circles) and GPS- (red crosses) height time series, and from coefficients provided by the GGFC (green diamonds). Left: **A**, right: **B**.

Question 2: Can a simple regression approach for modeling the site-specific atmospheric loading signal keep up with the corrections computed from global models?

The height corrections due to atmospheric loading computed using the coefficients estimated before were compared to the corrections described by Petrov and Boy (2004) (Petrov, L., J.P. Boy: *Study of the atmospheric pressure loading signals in very long baseline interferometry observations*. J. Geophys. Res., Vol. 109, B03405, doi:10.1029/2003JB002500, 2004).

For some stations, e.g. Gilmore Creek, Alaska (USA) or Hartebeesthoek (South Africa), the series are in good accordance regarding the annual domain. (See Figure 4.) However, there are many stations, such as Kokee, Hawaii (USA) and Ny-Ålesund (Norway), which show a quite bad agreement. Possible reasons for the disagreements are (1) a linear regression model with local pressure is physically not sufficient, (2) VLBI- and GPS-estimated coefficients additionally contain other signals, (3) the modeled crustal displacements are not good enough in some regions.

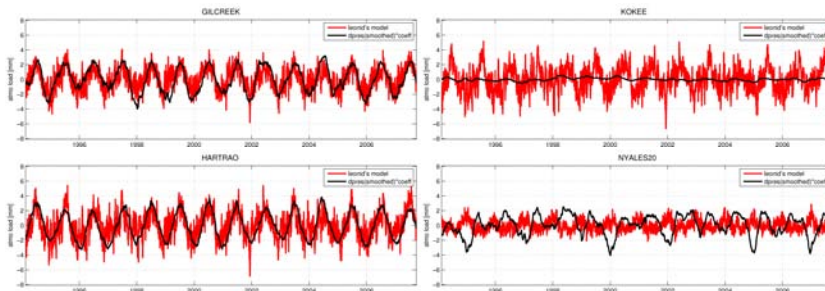

Figure 4. Comparison of smoothed “pressure times coefficient” series (thin black line) and modelled crustal displacement series (red) for the stations Gilcreek, Hartebeesthoek (Hartao), Kokee Park and Ny-Ålesund (Nyales20) (top to bottom, left to right).

3. DGFI contribution to the second realization of the ICRF (ICRF2)

DGFI takes part in the IVS Working Group for the second realization of the ICRF (ICRF2) by submitting all types of results necessary in this context. DGFI computes ICRF solutions, realizing the datum of ICRF by using no-net-rotation conditions, to enable a non-deformed CRF solution. The computation is based on, all together, 3131 sessions between January 1984 and August 2008, and it contains the coordinates of 2835 radio sources.

#### 4. IVS Operational Analysis Center at DGFI

DGFI was promoted from an associated analysis center to an operational analysis center in September 2008. DGFI routinely processes the standard IVS sessions (R1 and R4) supplemented by other sessions and delivers the resulting datum free normal equations to the IVS in SINEX format. In the case of relevant software updates, the VLBI normal equations are fully reprocessed and provided to the IVS. The latest update was the implementation of the Vienna Mapping Function (VMF1), where the complete time series (3131 sessions between 1984 and August 2008) was reprocessed and submitted to the IVS data server.

#### 5. IVS OCCAM Working Group

The most important goal for DGFI as an IVS AC is to maintain and refine the VLBI OCCAM software to current requirements in close collaboration within the IVS OCCAM Working Group, chaired by Oleg Titov, Geoscience Australia (Canberra, Australia). Other members are scientists from the Vienna University of Technology (Austria), the St. Petersburg University (Russia), the Institute of Applied Astronomy (Russia), and DGFI. During the past year the work concentrated on the development of software for subsequent processing of the OCCAM results.

### 3. Staff

The DGFI IVS AC is operated by Manuela Seitz and Robert Heinkelmann.



#### 4. Current Status and Activities

In 2008 DGFI received two new functions within IVS. DGFI became an operational IVS Analysis Center, and it was appointed together with BKG as an IVS Combination Center.

Dr. Volker Tesmer left DGFI at the end of August 2008, and Dr. Robert Heinkelmann (formerly of TU Vienna) followed in his position. We are very sorry for Dr. Tesmer's leaving the DGFI; nevertheless, we wish all the best to him and much success at his new position!

#### 5. Plans for 2009

For 2009, we plan to continue the IVS AC activities and the work within the ICRF2 Working Group. Together with BKG, DGFI will start the IVS Combination Center. We will install the DOGS-CS software for the combination work and develop and implement an appropriate strategy.

# FFI Analysis Center

*Per Helge Andersen*

## Abstract

FFI's contribution to the IVS as an analysis center focuses primarily on a combined analysis at the observation level of data from VLBI, GPS and SLR using the GEOSAT software. This report shortly summarises the current status of analyses performed with the GEOSAT software. FFI is currently an Analysis Center for IVS and ILRS, a Technology Development Center for IVS, and a Combination Research Center for IERS.

## 1. Introduction

A number of co-located stations with more than one observation technique have been established. In principle, all instruments at a given co-located station move with the same velocity, and it should be possible to determine one set of coordinates and velocities for each co-located site. In addition, a constant eccentricity vector from the reference point of the co-located station to each of the individual phase centers of the co-located antennas is estimated using constraints in accordance with a priori information given by the ground surveys. One set of Earth orientation parameters (EOP) and geocenter coordinates can be estimated from all involved data types. The present dominating error source of VLBI is the water content of the atmosphere, which must be estimated. The introduction of GPS data with a common VLBI and GPS parameterization of the zenith wet delay and atmospheric gradients will strengthen the solution for the atmospheric parameters. The inclusion of SLR data, which is nearly independent of water vapour, gives new information which will help in the de-correlation of atmospheric and other solve-for parameters and lead to more accurate parameter estimates. These, and many more advantages with the combination of independent and complementary space geodetic data at the observation level, are fully provided by the GEOSAT software developed by FFI.

After five years of development and extensive validation we are proud to announce that a major revision and extension of the GEOSAT software has been completed. The most important changes implemented have been described in recent IVS Annual Reports. Much more flexibility and automation have been added. Furthermore, the latest and “best” models (mostly following the IERS Standard) and “calibration tables” and “instrumental/geophysical event tables” have been included. Analysis of tracking data to S/C's in deep space has been added. For any technique, the delay due to the troposphere is determined with 3D raytracing using the European Center for Medium-Range Weather Forecast Numerical Weather Model. No mapping functions are used, and the corrections are determined directly from interpolation in the raytracing files.

## 2. Staff

Dr. Per Helge Andersen - Research Professor of Forsvarets forskningsinstitutt (FFI) and Institute of Theoretical Astrophysics, University of Oslo.

### 3. Combination of VLBI, GPS, and SLR Observations at the Observation Level

The processing of observations in GEOSAT is performed in three steps: 1) Omc step: for each individual technique generate files of residuals (observed minus calculated, omc) and partials for a period of “one arc” (usually 24 hours). Selected parameters are estimated to generate “small” residuals so that iterating in the filter is not necessary. 2) Comb step: combine omc files for all techniques at the epoch-by-epoch level using a UD (Upper-Diagonal factorized) sequential filter. The result is a SRIF (Square-Root-Information-Filter) array for that specific arc. 3) Global step: combine all arc SRIF arrays to generate a multi-year solution. The estimation is performed with a CSRIFS (Combined Square-Root-Information-Filter-and-Smoother factorized) sequential filter.

To perform the analyses we have a dedicated array of 10 state-of-the-art Linux work stations, each with 4 CPUs, 6 GB RAM, and 1 TB disk space.

The status of the analysis by January 2009 is as follows: New in 2008 is ambiguity resolution of undifferenced GPS data. Only resolved data are used in the analysis, which has reduced the number of GPS stations in the solution for each arc from approximately 175 to typically 135. The actual stations involved in an arc change in general from day to day so that many more GPS stations will be present in the global multi-year solution. Another extension is that the rates of the Earth orientation parameters are estimated. These changes and new SLR calibrations have made it necessary to repeat the time-consuming arc level analysis several times. The omc step is completed for the period October 1, 2002 to December 31, 2007. After extensive testing a “close to optimal” mix of solve-for parameters, constraints and weighting has been found for the combined analysis at the single arc level (Step 2). Among the estimated parameters are GM, a GPS antenna phase center offset to be added to the satellite-dependent phase center offsets and variations tabulated by IGS, and time dependent estimates of the geocenter, C20, C22 and S22. So far 1201 arcs have been processed at the comb level with this strategy. This is 63% of the days in the period October 1, 2002 to December 31, 2007. The first runs at the global multi-year level (Step 3) with these 1201 arcs are presently being performed. It is too early to draw any conclusions yet.

The expected outcome will be new realizations of TRF, CRF, and EOP relying on consistent models and estimation strategies. As a by-product a file of estimated eccentricity vectors will be produced. This type of analysis is along the lines of the ideas behind the GGOS project where geometry, gravity and Earth orientation are to be simultaneously and consistently determined.

We hope to include space-bourne gravity (accelerometer, gradiometer, sat-sat range/doppler, altimetry etc.) in GEOSAT for a simultaneous analysis with VLBI, SLR and GPS. This extension will be made possible by a close collaboration between Statens Kartverk and FFI.

## The BKG/IGGB VLBI Analysis Center

*Volkmar Thorandt, Axel Nothnagel, Gerald Engelhardt, Dieter Ullrich, Thomas Artz,  
Sarah Böckmann*

### Abstract

In 2008 the activities of the BKG/IGGB VLBI Analysis Center, as in previous years, consisted of routine computations of Earth orientation parameter (EOP) time series and a number of research topics in geodetic VLBI. The VLBI group at BKG continued its regular submissions of time series of tropospheric parameters and the generation of daily SINEX (Solution INdependent EXchange format) files. Quarterly updated solutions have been computed to produce terrestrial reference frame (TRF) and celestial reference frame (CRF) realizations. Routine computations of the UT1—UTC Intensive observations include all sessions of the Kokee—Wettzell and Tsukuba—Wettzell baselines and the networks Kokee—Svetloe—Wettzell and Ny-Ålesund—Tsukuba—Wettzell. The data analysis was refined by using atmospheric pressure loading time series, and further work for the IVS Working Group on ICRF2 has been finished. At IGGB the emphasis has been placed on individual research topics.

### 1. General Information

The BKG/IGGB VLBI Analysis Center has been established jointly by the Federal Agency for Cartography and Geodesy (BKG), Leipzig, and the Institute of Geodesy and Geoinformation of the University of Bonn (IGGB). Both institutions maintain their own analysis groups in Leipzig and Bonn but cooperate intensely in the field of geodetic VLBI. The responsibilities include data analysis for generating IVS products as well as special investigations with the goal of increasing accuracy and reliability. BKG is responsible for the computation of time series of EOP and tropospheric parameters, for the generation of SINEX files for 24-hour VLBI sessions and 1-hour Intensive sessions, and for the generation of quarterly updated global solutions for TRF and CRF realizations. Besides data analysis, the BKG group is also responsible for the scheduling of the Tsukuba—Wettzell INT2 UT1—UTC observing sessions. IGGB continues to host the office of the IVS Analysis Coordinator and carries out special investigations in the technique of geodetic and astrometric VLBI. Details of the research topics of BKG and IGGB are listed in Section 3.

### 2. Data Analysis

At BKG, the Mark 5 VLBI data analysis software system Calc/Solve, release of October 04, 2007, has been used for VLBI data processing. It is running under Fortran 90 on a machine with an operating system GNU/Linux 2.6.5-7.97-smp. It includes the new Calc 10 implementation for complying with the IAU 2000 Resolutions and the IERS Conventions 2003. The Vienna Mapping Function (VMF1) implemented in a Solve version modified in Leipzig for this purpose was used for all data analyses. There were no negative effects in the daily update of the VMF1 data from the server of the Technical University of Vienna. In addition, an independent technological software environment for the Calc/Solve software is available. The latter is used for linking up the Data Center management with the pre- and post-interactive part of the EOP series production and to monitor all Analysis and Data Center activities. (Data Center topics are described in the BKG Data Center report in this issue.)

- **Processing of correlator output**

The BKG group continued the generation of calibrated databases for the sessions correlated at the MPIfR/BKG Mark 5 Astro/Geo Correlator at Bonn (e.g., EURO, OHIG, and T2) and submitted them to the IVS Data Centers.

- **Scheduling**

BKG continued scheduling the INT2 Intensive sessions which are observed on the baseline TSUKUBA-WETTZELL. Altogether 101 schedule files were created in 2008.

- **IVS EOP time series**

A new EOP time series bkg00011 was created. It differs from the previous one by using the atmospheric pressure loading time series provided by GSFC. Furthermore station coordinates and velocities for positions of DSS65A, METSAHOV, and ZELENCHK have been estimated in a global multi-session mode with about 3 years of data gathered up to now.

Each time after the preprocessing of any new VLBI session (correlator output database version 1), a new global solution with 24-hour sessions since 1984 has been computed, and the EOP time series bkg00011 has been extracted. Altogether 3,740 sessions have been processed. The main parameter types in this solution are globally estimated station coordinates and velocities together with radio source positions. Minimal constraints for the datum definition were applied to achieve no-net-rotation and no-net-translation for 26 selected station positions and velocities with respect to VTRF2005 and no-net-rotation for 212 defining sources with respect to ICRF-Ext.1. The station coordinates of the stations BADARY (Russia), CTVASTJ (Canada), DSS13 (USA), and YEBES40M (Spain) were estimated as local parameters in each session.

The UT1-UTC time series bkgint07 was continued. In addition to the observations of both baselines KOKEE-WETTZELL and TSUKUBA-WETTZELL, also the networks KOKEE-SVETLOE-WETTZELL and NYALESUND-TSUKUBA-WETTZELL, each with a duration of about 1 to 1.5 hours, were processed regularly. Series bkgint07 was generated with fixed TRF (VTRF2005) and fixed CRF derived from the global BKG solution for EOP determination. The estimated parameter types were only UT1-TAI, station clock, and zenith troposphere. A total of 2,733 UT1 Intensive sessions were analyzed for the period between 1999.01.01 and 2008.12.31.

- **Quarterly updated solutions for submission to IVS**

Also in 2008, quarterly updated solutions were computed for the IVS products TRF and CRF. There are no differences in the solution strategy compared to the continuously computed EOP time series bkg00011. The results of the radio source positions were submitted to IVS in IERS format. The TRF solution is available in SINEX format, version 2.1 and includes station coordinates, velocities, and radio source coordinates together with the covariance matrix, information about constraints, and the decomposed normal matrix and vector.

- **Tropospheric parameters**

The VLBI group of BKG continued regular submissions of long time series of tropospheric parameters to the IVS (wet and total zenith delays, horizontal gradients) for all VLBI sessions since 1984. The tropospheric parameters are directly extracted and transformed into SINEX for tropospheric estimates from the results of the standard global solution for the EOP time series bkg00011.



- **Daily SINEX files**

The VLBI group of BKG also continued the regular submissions of daily SINEX files for all available 24-hour sessions as base solutions for the IVS time series of baseline lengths and for combination techniques. In addition to the global solutions, independent session solutions were computed for the parameter types station coordinates, EOP, and nutation parameters. The a priori datum for TRF is defined by the VTRF2005, and the fixed CRF derived from the global complete BKG solution for EOP determination is used for the a priori CRF information.

- **SINEX files for Intensive sessions**

Due to special requirements from IVS, SINEX files for Intensive sessions were created. The parameter types are station coordinates, pole coordinates and their rates, and UT1-TAI with rate. But only the normal equations stored in the SINEX files are important for further combination with other space geodetic techniques.

### 3. Research Topics

- **Statistical tests for ICRF2**

At BKG, the main work in 2008 has been the analysis of the time series of all radio sources computed in special CRF runs. Statistical tests to identify normal distribution of the residuals w.r.t. the weighted mean have been made for radio sources which had been observed in at least 20 sessions. The statistical hypothesis of normal distribution was not rejected for 227 radio sources in both components, declination and right ascension, and for 62 radio sources in only one component. After the successful test for normal distribution, an inspection of WRMS, of rate estimation, and of distribution of the data points (sessions) in time was also necessary to answer the question of whether sources can be considered as being stable.

- **Terrestrial reference frame for ICRF2**

For the computations of solutions for ICRF2, it was agreed that all analysis centers participating in ICRF2 work use the same terrestrial reference frame (TRF). For this purpose, VTRF2008, which had been computed at Bonn at the same time, was selected. The details are described in the IVS Analysis Coordinator's report.

- **Sub-daily EOP determinations**

At Bonn, the modelling of sub-daily EOP variations has been pursued further. For this, the Solve analysis software has been modified to permit the extraction of the design matrix for subsequent processing in a separate inversion program. The normal matrix of several VLBI sessions can be stacked to form a multi-session set of normal equations. Through this method, for example, the breaks in the CONT sessions can be bridged, reducing the noise in the sub-daily EOP at the session boundaries. Based on this modified analysis approach, several CONT campaigns have been re-analyzed and compared in the frequency domain.

- **Modifications of the local installation of Solve**

The version of Solve installed at Bonn has been modified for a number of purposes. For combination studies with GPS, the logic of Solve was changed in order to produce EOP at full integer hours even for sessions which do not start at the full hour. For this and also other combination purposes, routines were added to extract the full design matrix and the system

of normal equations. These could then be processed with stand-alone inversion and analysis programs.

- **Systematic differences in EOP series**

In 2006, the y-component of polar motion of all IVS Analysis Centers showed significant bumps in the time series when forming the differences w.r.t. the IGS results (Fig. 1). In 2008, this phenomenon was studied in detail, and possible causes were tested.

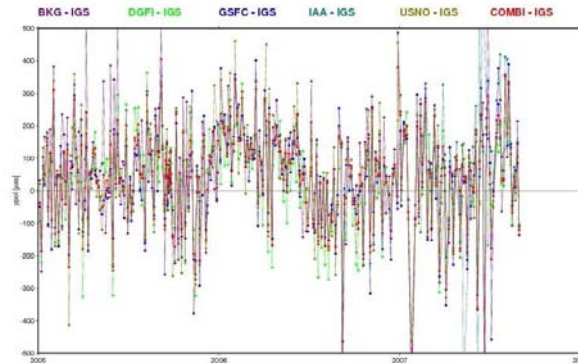

Figure 1. Differences w.r.t. IGS in y pole component with systematic bumps in 2006

The conclusion of these investigations was that the appearance of the systematics was mainly driven by the results of the IVS-R4 sessions. This network was particularly affected by major changes in network constellations since GILCREEK (Dec. 31, 2005) and ALGOPARK (Aug. 5, 2006) dropped out of operation. Due to this, the R4 network appeared with an elongated shape from Hawaii and South America to Europe. The reduced sensitivity also became obvious through higher formal errors of the estimated EOP.

#### 4. Personnel

Table 1. Personnel at BKG/IGGB Analysis Center

Thomas Artz	IGGB	+49-228-733563	thomas.artz@uni-bonn.de
Sarah Böckmann	IGGB	+49-228-733563	boeckmann@uni-bonn.de
Gerald Engelhardt	BKG	+49-341-5634438	gerald.engelhardt@bkg.bund.de
Axel Nothnagel	IGGB	+49-228-733574	nothnagel@uni-bonn.de
Volkmar Thorandt	BKG	+49-341-5634285	volkmar.thorandt@bkg.bund.de
Dieter Ullrich	BKG	+49-341-5634328	dieter.ullrich@bkg.bund.de
Reiner Wojdziak	BKG	+49-341-5634286	reiner.wojdziaak@bkg.bund.de

# GSFC VLBI Analysis Center

*David Gordon, Chopo Ma, Dan MacMillan, John Gipson, Karen Baver*

## Abstract

This report presents the activities of the GSFC VLBI Analysis Center during 2008. The GSFC Analysis Center analyzes all IVS sessions, makes regular IVS submissions of data and analysis products, and performs research and software development aimed at improving the VLBI technique.

## 1. Introduction

The GSFC VLBI Analysis Center is located at NASA's Goddard Space Flight Center in Greenbelt, Maryland. It is part of a larger VLBI group which also includes the IVS Coordinating Center, the CORE Operation Center, a Technology Development Center, and a Network Station. The Analysis Center participates in all phases of geodetic and astrometric VLBI analysis, software development, and research aimed at improving the VLBI technique.

## 2. Activities

### 2.1. Analysis Activities

The GSFC analysis group analyzes all IVS sessions using the Calc/Solve system, and it performs the AIPS fringe fitting and Calc/Solve analysis of the VLBA-correlated RDV sessions. The group submits the analyzed databases to IVS for all R1, RDV, R&D, CONT08, NEOS INT01, and INT03 sessions. During 2008, the group processed and analyzed 189 24-hour (49 R1, 53 R4, 6 RDV, 18 R&D, 5 CONT08, 6 EURO, 9 T2, 10 OHIG, 5 CRF, 8 CRDS, 3 CRMS, 2 CRFS, 1 CRD, and 14 JADE) sessions and 366 1-hour UT1 (230 NEOS INT01, 95 INT02, and 41 INT03) sessions. We also submitted updated EOP files and daily Sinex solution files for all IVS sessions to the IVS Data Centers immediately following analysis. The group also generated and submitted one TRF solution to the IVS Data Centers using all suitable VLBI sessions. The GSFC Analysis Center maintains a Web site at <http://lupus.gsfc.nasa.gov>, where the latest solutions and velocity plots can be found.

### 2.2. Research Activities

The GSFC Analysis Center performs ongoing research aimed at improving the VLBI technique. Several of these research activities are described below:

- **ICRF2 Preparations:** The analysis group is participating in the development of the next realization of the International Celestial Reference Frame (ICRF2). Source time series solutions were made to study the stability of the VLBI sources. Time series position plots and various statistical quantities were studied to identify stable and unstable sources. Two methods were developed to select stable candidate sources for use in defining the axes of ICRF2. In the first, we picked 300 sources evenly distributed in declination with the lowest WRMS position variation in 17 declination zones. Second, we picked 386 apparently stable sources based on examination of their time series plots and their WRMS positions and Chi-squares per-degree-of-freedom. Also, numerous source catalog solutions were generated to study the best ways

to generate the final catalog and to try to determine what its noise level and noise floor will be. The solutions included: tests of observation and session decimation; tests using different data ranges (starting in 1979, 1990, and 1993); tests using different session types (with and without small and regional networks); tests with unstable sources treated as global vs. arc parameters; tests with pressure loading on vs. off; tests with axis offsets estimated vs. not estimated; and tests treating site positions as global vs. arc parameters. The decimation studies indicated that the source formal errors should be increased by  $\sim 50\%$ . Little difference was found in starting with 1990 vs 1979, but the 1993 start showed a noticeable increase in source formal errors. Adding the small networks (mobiles, regionals, and ties) degraded the source time series solutions, but had little effect on the source catalog solutions.

- **VLBI2010 Simulations:** VLBI2010 network simulation studies were made for the IVS VLBI2010 committee. Specifically, we investigated different strategies for improving geodetic performance: 1) optimized observing schedules, 2) more observations due to faster antenna slewing rates, 3) improved analysis strategies, and 4) larger antenna networks. It was found that the 3D WRMS position errors are reduced from current best levels (e.g., CONT sessions) by a factor of 2-3 when the antenna slew rate increases by a factor of 3-4 over current average rates. It was also found that applying elevation dependent weighting reduces the 3D WRMS position errors by 20-30%. Accounting for correlated site-dependent noise between observations in each scan yielded an additional reduction of about 10%. Simulations of global networks show that scale and EOP scatter is reduced by about a factor of 2 as the network size increases from 8 to 32 sites. We also found generally good agreement of our results with those obtained with the OCCAM and point-positioning software packages at Vienna Technical University. Additional work is needed to resolve differences between our results—for example, in comparisons of simulations versus observed data results and model sensitivities to observation noise and switching interval.
- **SLR/VLBI Network Design:** We continued simulation work on the design of a network of co-located VLBI and SLR antennas. The goal is to define and maintain the terrestrial reference frame at a level of 0.1 mm/yr to support global change monitoring. For VLBI, we generated daily observing schedules and simulated delay noise. Observation files and session parametrization files were generated and input to the GSFC software Geodyn package for combination. We are currently investigating the performance of networks of 8 to 32 sites similar to the networks used for VLBI2010 work.
- **Ny-Ålesund Site Motion:** We have investigated the motion of Ny-Ålesund as observed by VLBI as part of a paper submitted to Journal of Geodynamics [1] which compares coordinate time series and velocity estimates from VLBI, GPS, and DORIS. The observed uplift of Ny-Ålesund is twice that predicted by postglacial rebound and present day ice melting of nearby glaciers. The GPS and VLBI uplift rates show an increase of 3-4 mm/yr between measurements before 2003 and after 2003.
- **Antenna Thermal Deformation:** We implemented antenna thermal deformation as a contribution that can be applied in Calc/Solve analysis. The contribution can be in the form of 1) a measured height series (such as an invar wire length time series that provides a direct measure of the vertical variation of the reference point position) or, (2) antenna reference point variation derived using a model. The model for each antenna consists of antenna dimensions, antenna material expansion coefficients, reference temperature, and observed temperature.

We ran baseline solutions applying the model using antenna information compiled by A. Nothnagel and found improvement in length repeatabilities of up to 1 mm. The level of improvement was similar to previous tests using less complete antenna information. Based on TRF solutions, the effect of thermal deformation on the terrestrial reference frame is insignificant, where the effect on the scale was  $\sim 0.01$  ppb.

- **Correlated Noise:** We implemented station dependent correlated noise in Calc/Solve. Tests of the effects of correlated noise using good VLBI data sets, such as CONT05 or the R1's and R4's for 2005-2006, show that including mapping function-like correlated noise improves the VLBI solutions in the following ways: 1) reduced baseline scatter; 2) reduced scatter in source positions; 3) better agreement between simultaneous independent VLBI measurements of EOP; and 4) better agreement between VLBI and IGS measurements of EOP.
- **New Geodetic Sources.** The Goddard VLBI group expanded the geodetic source catalog by 189 sources. These sources were chosen by L. Petrov based on compactness, lack of structure, and source strength. Since many of these sources had not been observed recently, we decided to observe them in a series of four R&D sessions prior to regular inclusion in the R1's. The first of these R&D's was scheduled for April 2008 and the last for September 2008. After verifying that these sources were successfully observed and updating the flux catalog, we gradually added these sources to the regular geodetic catalog starting in October 2008.
- **RDV Paper:** A paper on the use of the VLBA for geodesy [2] was prepared and submitted to the Journal of Geodesy. It reports on 14 years of geodetic observations and presents station displacements due to crustal motion, earthquakes, and antenna axis tilts. It will be published in 2009.
- **Higher Frequency CRF:** Members of the analysis group continued working with associates at JPL, USNO, NRAO, and Bordeaux Observatory to extend the celestial reference frame to higher frequencies by using the VLBA at K and Q bands ( $\sim 24$  and  $\sim 43$  GHz). The primary goals are to build up a reference frame for use in planetary spacecraft navigation at Ka band ( $\sim 33$  GHz), and to build a reference frame less affected by source structure and potentially more precise than the current X/S frame. The K/Q group prepared and submitted two papers on this work to the Astronomical Journal. Paper I [3] presents and discusses the K-band reference frame and Paper II [4] presents and discusses the K and Q band imaging results.

### 2.3. Software Development

The GSFC group develops and maintains the Calc/Solve analysis system. Calc/Solve is a package of approximately 120 programs and 1.2 million lines of code. Several updates were released during 2008.

### 2.4. Support Activities

The GSFC VLBI Analysis Center has provided a source position service as part of the RDV program since 1997. Observations of 76 requested sources were made in 2008 for members of the astronomy and astrometry community, and precise positions were obtained for most of them.

### 3. Staff

The Analysis Center consists of a GSFC civil servant, Dr. Chopo Ma, and four NVI, Inc. employees who work under contract to GSFC. Table 1 lists these staff members alphabetically, except for Dr. Ma, who oversees the entire GSFC VLBI project for GSFC, and Dr. John Gipson, the GSFC VLBI Project Manager. Dr. Ma is also the IVS representative to the IERS, the current chair of the IERS directing board, and the chair of the IVS/IERS ICRF2 working group. Dr. Gipson is also the chair of IVS Working Group 4 on VLBI Data Structures. Dr. David Gordon and Dr. Daniel MacMillan lead contract tasks that support the Analysis Center.

This year, after eight productive years at the Analysis Center, Leonid Petrov left to join another GSFC project. His many responsibilities are being divided among the remaining group members. To learn the new point of contact for a specific task, please contact John Gipson (John.M.Gipson@nasa.gov) or Dan MacMillan (Daniel.S.MacMillan@nasa.gov).

Table 1. Staff members and their main areas of activity.

Dr. Chopo Ma	CRF, TRF, EOP, K/Q reference frame development
Dr. John Gipson	source monitoring, station dependent noise, parameter estimation
Ms. Karen Baver	Intensive analysis and monitoring, software development, Web site
Dr. David Gordon	Analysis of 24-hour sessions, RDV processing and analysis, K/Q reference frame development, VLBA calibrator surveys, Calc development, ICRF2 development
Dr. Daniel MacMillan	CRF, TRF, EOP, mass loading, antenna deformation, apparent proper motion, post-seismic studies, ICRF2 development

### 4. Future Plans

Plans for the next year include: participation in the development of the ICRF2, participation in VLBI2010 development efforts, participation in the development of a new VLBI data structure, participation in additional K/Q observations and high frequency reference frame development, and performing further research aimed at improving the VLBI technique.

### References

- [1] “The Kinematics of Ny-Ålesund from Space Geodetic Data”, H. Kierulf, B.Pettersen, D. MacMillan, and P. Willis; submitted to Journal of Geodynamics.
- [2] “Precise Geodesy with the Very Long Baseline Array”, L. Petrov, D. Gordon, J. Gipson, D. MacMillan, C. Ma, E. Fomalont, R. C. Walker, and C. Carabajal; submitted to Journal of Geodesy.
- [3] “The Celestial Reference Frame at Higher Radio Frequencies. I. Astrometry from VLBA Observations at 24 and 43 GHz”, G. Lanyi, D. Boboltz, P. Charlot, A. Fey, E. Fomalont, B. Geldzahler, D. Gordon, C. Jacobs, C. Ma, C. Naudet, J. Romney, O. Sovers, and L. Zhang; submitted to Astronomical Journal.
- [4] “The Celestial Reference Frame at Higher Radio Frequencies. II. VLBA Imaging at 24 and 43 GHz”, P. Charlot, D. Boboltz, A. Fey, E. Fomalont, B. Geldzahler, D. Gordon, C. Jacobs, G. Lanyi, C. Ma, C. Naudet, J. Romney, O. Sovers, and L. Zhang; submitted to Astronomical Journal.

# IAA VLBI Analysis Center Report 2008

*Elena Skurikhina, Sergey Kurdubov, Vadim Gubanov*

## Abstract

This report presents an overview of IAA VLBI Analysis Center activities during 2008 and the plans for the coming year.

## 1. General Information

The IAA IVS Analysis Center (IAA AC) is located at the Institute of Applied Astronomy of the Russian Academy of Sciences in St. Petersburg, Russia. IAA AC contributes to IVS products, such as daily SINEX files, TRF, CRF, rapid and long-term series of EOP, baseline length, and tropospheric parameters. Source position time series and CRF have been calculated within the scope of the IERS/IVS Working Group on the Second Realization of the ICRF. Several ways of source selection with NNR constraints were proposed and tested. EOP, UT1-UTC, and station positions were estimated from domestic observation programs RU-E and RU-U. AC IAA generates NGS files.

## 2. Component Description

AC IAA performs data processing of all kinds of VLBI observation sessions. For VLBI data analysis we use the QUASAR and the OCCAM/GROSS software packages. All reductions are performed in agreement with IERS Conventions (2003). Both packages use NGS files as input data.

AC IAA submits to the IVS Data Center all kinds of products: daily SINEX files for EOPs and EOPS-rates and station position estimations, TRF, CRF, baseline length, and tropospheric parameters.

The QUASAR and the OCCAM/GROSS software packages are supported and developed further.

IVS NGS files are generated in automatic mode on a regular basis.

## 3. Staff

– Vadim Gubanov, Prof.: development of the QUASAR software and development of the methods of stochastic parameter estimation.

– Sergey Kurdubov, scientific researcher: development of the QUASAR software, global solution, and DSNX file calculation.

– Elena Skurikhina, Dr.: team coordinator, VLBI data processing, and OCCAM/GROSS software development.

## 4. Current Status and Activities

### • Software development for VLBI processing

The QUASAR software is being developed to provide contributions to IVS products. The

software is capable of calculating all types of IVS products.

- **Global solution**

In 2008 two global solutions (iaa2007b and iaa2008a) using the QUASAR software were calculated and submitted to IVS. All available data for 1979–2008 were processed. Stochastic signals were estimated by means of the least-squares collocation technique. The radio source coordinates, station coordinates, and velocities were estimated as global parameters. EOP, WZD (linear trend plus stochastic signal), troposphere gradients, and station clocks (quadratic trend plus stochastic signal) were estimated as arc parameters for each session.

4,202 24-hour sessions with 5,882,972 delays have been processed. 3,165 global parameters have been estimated: 1,038 radio source positions, and the positions and the velocities of 141 VLBI stations (14 with discontinuities). Also the following parameters were estimated: PPN parameter  $\gamma = -0.0002 \pm 0.0002$ ; the nominal values of Love numbers  $h2_0 = 0.6078$  and  $l2_0 = 0.0847$  and their corrections  $dh2_0 = 0.0016 \pm 0.0003$  and  $dl2_0 = -0.0002 \pm 0.0001$ ; and tidal lag  $= -3.3' \pm 1'$ .

- **Participation at the IERS/IVS Working Group on the Second Realization of the ICRF**

Time series for more than 600 sources were calculated using the QUASAR software for VLBI data processing. Source positions for every source were obtained from single series analysis by fixing the coordinates of all the sources. A priori source positions were used from the ICRF-Ext.2 radio source position catalog. Time series analysis is performed with the covariation analysis technique adopted for equidistant time series with the aim of detecting more stable sources. Global solutions with different sets of sources for NNR constraints were obtained. Transformation parameters between obtained source catalogs were calculated and compared.

Two ways of selecting the set of defining sources were proposed and tested. The first used covariation functions for the time series analysis, and the second used orientation parameter accuracy functions for radio source catalogs.

- **Routine analysis**

Since March 2007, AC IAA has submitted daily SINEX files for the IVS-R1 and IVS-R4 sessions as rapid solution (iaa2008a.snx) and SINEX files based on all 24-hour experiments for the Quarterly Solution.

During 2007 the routine data processing was performed with the OCCAM/GROSS software using a Kalman Filter. IAA AC operationally processed the “24h” and Intensive VLBI sessions. Submitting the results to the IERS and IVS was performed on a regular basis. Processing of the Intensive sessions is fully automated. The EOP series iaa2007a.eops and iaa2005a.eopi, baseline lengths iaa2007a.bl, and troposphere parameters iaa2007a.trl were continued. At the moment, the EOPS series contains 3,463 estimates of pole coordinates, UT1, and celestial pole offsets, and the EOPI series contains 5,821 estimates of UT1. Long-time series of station coordinates, baseline lengths, and tropospheric parameters (ZTD, gradients) were computed with the station position catalog ITRF2005.



• **EOP parameter calculation from domestic QUASAR network observations**

The regular determinations of Earth’s orientation parameters with QUASAR VLBI-Network Svetloe-Zelenchukskaya-Badary using the S2 registration system started in August of 2006 [5]. Correlation is performed at the IAA correlator. The observations are carried out in the framework of two national programs: 24-hour sessions for the determination of five EOP parameters from the full network (RU-E program) and 8-hour sessions for the determination of Universal Time on the Zelenchukskaya—Badary baseline (RU-U program). Each of these two sessions is run twice per month. The mean RMS EOP deviations from the IERS 05C04 series in the RU-E program are 0.83 mas for Pole position, 43 s for UT1-UTC, and 0.69 mas for Celestial Pole position. The RMS deviation of the Universal Time values from the IERS C04 series for the RU-U program is 110  $\mu$ s. First results of observations using the Mark 5B registration system were obtained. Station positions were specified in the ITRF2005 and VTRF2008 catalog systems for both domestic and IVS observations.

• **FCN study**

Retrograde Free Core Nutation (RFCN) from VLBI observation data analysis was performed by Prof. V. Gubanov [1, 2]. At the first step, Celestial pole offset time series referred to the new model IAU 2000 ( $X_c$ ,  $Y_c$ ) were analyzed. Analysis of the combined IERS&NEOS time series by the envelope method in the interval 1984-2008 has shown that both amplitude and frequency vary in a wide range. Retrograde Free Core Nutation (RFCN) periods estimated for three consecutive time intervals (see Figures 1 and 2) amounted to (1)  $-423.2 \pm 0.3$ , (2)  $-667.5 \pm 0.8$  and (3)  $-452.4 \pm 0.4$  days. An analysis using the S. Lambert RFCN model [3] leads to close results.

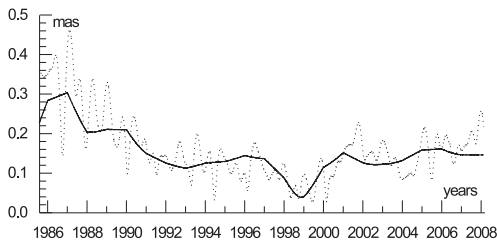

Figure 1. Variations of the RFCN amplitudes derived from the LAM (solid line) and LSC (dotted line) models

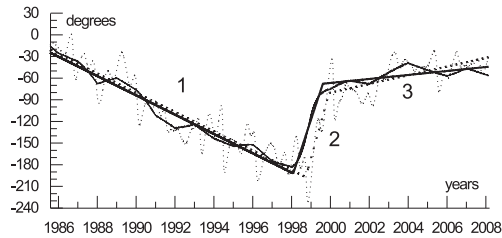

Figure 2. RFCN phase variations and their trends derived from the LAM (solid line) and LSC (dotted line) models

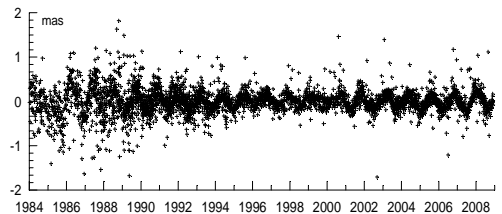
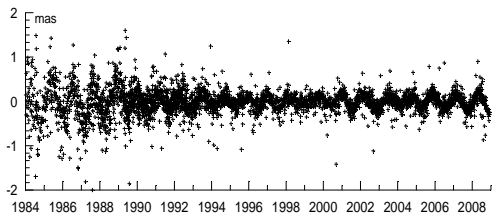

Figure 3. Weighted mean daily values of  $X_c$  (left) and  $Y_c$  (right)

In a further study, RFCN new  $X_c$ ,  $Y_c$  time series were calculated with QUASAR software. These time series were combined with more long time series from several IVS ACs (AUS, BKG, GSFC, IAA, OPA, SPbU, and USNO) after removing polynomial trends [1]. As a result the time series of CIP from 3,741 points presented in Figure 3 was generated. Further amplitude-frequency analysis of the RFCN time series is planned.

## 5. Future Plans

- We plan to continue to submit all types of IVS product contributions and to start to submit SINEX files for IVS Intensive sessions.
- Continue investigations of VLBI estimation of EOP, station coordinates, and troposphere parameters, and comparison with satellite techniques.
- Continue studies in the frame of the IERS/IVS Working Group on the Second Realization of the ICRF.
- Further improvement of algorithms and software for processing VLBI observations.

## References

- [1] V. Gubanov (2009), *Astron. Letters*, Vol. 35, No. 2, pp. 1-9.
- [2] V. Gubanov, "The Phase Variations of Retrograde Free Core Nutation", *Measuring the future, Proceedings of the Fifth IVS General Meeting* ed. A. Finkelstein, D. Behrend, St-Petersburg, "Nauka", 2008, pp. 231-235.
- [3] S. Lambert (2007), <ftp://tai.bipm.org/iers/convupdt/chapter5/fcnnut.f>
- [4] S. Kurdubov, E. Skurikhina, *Source positions time series generation and analysis. Journees 2007* ISBN 978-2-901057-59-9, 2008, 44-45.
- [5] A. Finkelstein, E. Skurikhina, I. Surkis, A. Ipatov, I. Rahimov, S. Smolentsev, "QUASAR National Programs of EOP Determinations", *Measuring the future, Proceedings of the Fifth IVS General Meeting*, ed. A. Finkelstein, D. Behrend, St-Petersburg, "Nauka", 2008, pp. 319-323.
- [6] S. Kurdubov, E. Skurikhina, "Source selection for NNR constraints from source position time series", *Measuring the future, Proceedings of the Fifth IVS General Meeting* ed. A. Finkelstein, D. Behrend, St-Petersburg, "Nauka", 2008, pp. 279-283.

## Vienna IGG Special Analysis Center Annual Report 2008

*Harald Schuh, Johannes Boehm, Sigrid English, Robert Heinkelmann,  
Paulo Jorge Mendes Cerveira, Andrea Pany, Lucia Plank, Hana Spicakova, Kamil Teke,  
Joerg Wresnik*

### Abstract

The main activities of the Institute of Geodesy and Geophysics (IGG) at the Vienna University of Technology in 2008 have been the contribution to the VLBI2010 simulations and the development of new VLBI software based on Matlab. Furthermore, studies about Earth rotation and reference frames have been continued.

### 1. General Information

The Institute of Geodesy and Geophysics (IGG) is part of the Faculty of Mathematics and Geoinformation of the Vienna University of Technology. It is divided into three research units, one of them focusing on advanced geodesy (mathematical and physical geodesy, space geodesy). Within this research unit, one group (out of four) is dealing with geodetic VLBI.



Figure 1. Some members of the VLBI group at IGG at the EGU General Assembly 2008 in Vienna. Standing: Robert Heinkelmann, Andrea Pany, Joerg Wresnik, Harald Schuh, Hana Spicakova; in the front: Sigrid English, Paulo Jorge Mendes Cerveira, Johannes Boehm.

## 2. Staff

Personnel at IGG associated with the IVS Special Analysis Center in Vienna are Harald Schuh (Head of IGG, Chair of the IVS Directing Board) and nine scientific staff members. Their main research fields are summarized in Table 1.

Table 1. Staff members ordered by the main focus of research.

Johannes Boehm	VLBI2010, Vienna VLBI Software (VieVS)
Andrea Pany	VLBI2010, troposphere, turbulence theory
Joerg Wresnik	VLBI2010, scheduling
Kamil Teke	VieVS (least squares adjustment)
Lucia Plank	VieVS (Earth orientation)
Hana Spicakova	VieVS (station displacements)
Sigrid English	Earth orientation, tidal influences
Paulo Jorge Mendes Cerveira	Earth orientation, datum definition
Robert Heinkelmann (until Nov. 2008)	Combination, celestial and terrestrial reference frame

## 3. Current Status and Activities

- **Vienna VLBI Software (VieVS)**

In 2008 the IGG Vienna started to write new software for VLBI with Matlab. This VLBI software will not be written from scratch. Instead we will rely on the existing software package Occam which is used at the IGG Vienna. This work is also closely related to IVS Working Group 4 on VLBI Data Structures, which is chaired by John Gipson.

- **VLBI2010**

A lot of effort was dedicated to the VLBI2010 Monte Carlo simulations. Using the Occam (Wresnik et al., 2008 [4]) and Precise-Point-Positioning (PPP) (Pany et al., 2008 [2]) simulators, the impact of antenna slew rates (Petrachenko et al., 2008 [3]) and the main stochastic error sources (troposphere, clock and measurement error) on VLBI analysis results were investigated. As an example, Figure 2 shows the influence of the station clock accuracy on the 3D position rms, simulated with the three software packages Solve, Occam, and PPP.

- **Earth rotation**

Two ERP time series with hourly resolution were estimated from observational data from the years 1984-2007, using the conventional reference frames ITRF2005 and ICRF Ext.2 as well as an internal VLBI-only reference frame solution IGG07R04. A set of 77 ocean tidal constituents in the diurnal and semi-diurnal frequency bands was determined from both ERP solutions (ITRF2005 and IGG07R04) and compared to the IERS2003 conventional model (English et al., 2008 [1]) (Figure 3).

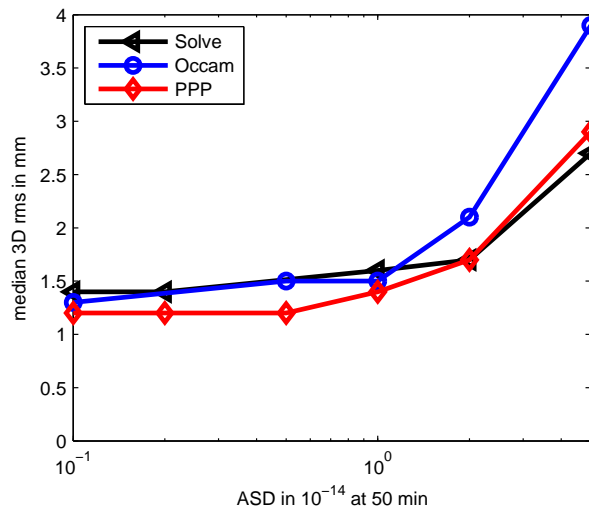

Figure 2. VLBI2010: Influence of the Allan Standard Deviation (ASD) of the station clocks on median 3D position rms in mm with the Occam and PPP simulations; the Solve simulations were done at GSFC.

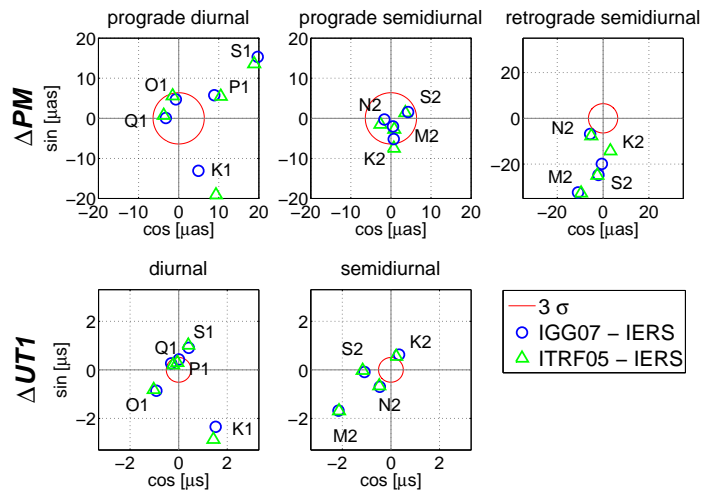

Figure 3. Earth rotation: Phasor plots of the major ocean tidal terms in polar motion (PM) and universal time (UT1) w.r.t. the IERS2003 conventional model.

#### 4. Future Plans

In 2009 we will focus on the development of the new VLBI software VieVS. This software will also include a tool for scheduling purposes. Additionally, we will continue to contribute to the ongoing activities within VLBI2010 and to carry out Earth orientation and reference system studies.

## 5. Acknowledgements

We are very grateful to the Austrian Science Fund (FWF) for supporting our work by research projects P16992-N10 (“VLBI for climate studies”), and P18404-N10 (“VLBI2010”). We also acknowledge the Austrian Academy of Sciences for funding project 22353 and the German Research foundation (DFG) for funding project SPEED (SCHU 1103/3-1).

## References

- [1] Englich, S., R. Heinkelmann, H. Schuh, Re-assessment of Ocean Tidal Terms in High-Frequency Earth Rotation Variations Observed by VLBI, “Measuring the Future”, Proceedings of the 5th IVS General Meeting, A. Finkelstein, D. Behrend (Eds.), Institute of Applied Astronomy RAS 2008, Publishers “Nauka”, ISBN 978-5-02-025332-2, 314-318, 2008.
- [2] Pany, A., J. Wresnik, J. Boehm, H. Schuh, Vienna VLBI2010 PPP Simulations, “Measuring the Future”, Proceedings of the 5th IVS General Meeting, A. Finkelstein, D. Behrend (Eds.), Institute of Applied Astronomy RAS 2008, Publishers “Nauka”, ISBN 978-5-02-025332-2, 427-432, 2008.
- [3] Petrachenko, B., J. Boehm, D. MacMillan, A. Niell, A. Pany, A. Searle, J. Wresnik, VLBI2010 Antenna Slew Rate Study, “Measuring the Future”, Proceedings of the 5th IVS General Meeting, A. Finkelstein, D. Behrend (Eds.), Institute of Applied Astronomy RAS 2008, Publishers “Nauka”, ISBN 978-5-02-025332-2, 410-415, 2008.
- [4] Wresnik, J., J. Boehm, A. Pany, H. Schuh, VLBI2010 Simulations at IGG Vienna, “Measuring the Future”, Proceedings of the 5th IVS General Meeting, A. Finkelstein, D. Behrend (Eds.), Institute of Applied Astronomy RAS 2008, Publishers “Nauka”, ISBN 978-5-02-025332-2, 421-426, 2008.

# Italy INAF Analysis Center Report

*M. Negusini, P. Sarti, C. Abbondanza*

## Abstract

This report summarizes the activity of the Italian INAF VLBI Analysis Center. Our Analysis Center is located in Bologna, Italy and belongs to the Institute of Radioastronomy, which is part of the National Institute of Astrophysics. IRA runs the observatories of Medicina and Noto, where two 32 m VLBI AZ-EL telescopes are situated. This report contains the AC's VLBI data analysis activities and shortly outlines the investigations carried out at Medicina and Noto concerning gravitational deformations of the VLBI telescopes.

## 1. Current Status and Activity

Data analysis of terrestrial surveys carried out during 2008 focused on the investigation of deformation under the effects of gravity and, in particular, on the possibility of inferring a general model for gravitational deformations of large VLBI telescopes. The strategy used relies on the combination of different metrological approaches applied to the antennas: on one hand, classical terrestrial surveys executed via forward intersections on some specific targets located on the telescope's primary reflector and on the quadrupod; on the other, laser scanning surveys which allow analysts to infer a more continuous representation of the parabolic mirror deformation. A third kind of information was derived from Finite Element Modelling (FEM) which provides a scenario of feasible deformations of the antenna structure at its peculiar nodes under the influence of its own weight. The joint usage of these data types permitted us to identify, quantify and detach the effects of gravitational deformations: according to [1], these latter can be decomposed into a *(i)* paraboloid's vertex displacement, *(ii)* relative motion of the S/X receivers placed in the primary focus with respect to the antenna primary reflector, *(iii)* a focal length variation induced by deformations of the VLBI reflector. This combination approach might offer valuable help for estimating a signal path variation model induced by gravity to be applied within VLBI data processing.

Concerning the laser scanning measurement analysis, a specific focal length variation model, valid for the Medicina and Noto antennas, was derived with the aim of supplying a model which can account for the relative change in focal length as the VLBI antenna is steered in elevation; results of these considerations can be found in [2], which has been reviewed and is in the course of publication.

## 2. Data Analysis and Results

The IRA started to analyze VLBI geodetic databases in 1989, using a CALC/SOLVE package on the HP1000 at the Medicina station. In subsequent years, the same software was installed first on an HP360 workstation and later on an HP715/50 workstation. In more recent years, two HP785/B2600 workstations and an HP282 workstation were used. In 2007, a new Linux workstation was set up for the migration of all the VLBI data analysis, and Mark 5 Calc/Solve was installed. During 2008, we stored all the 1999–2008 databases available on the IVS data centers. All the databases were processed and saved with the best selection of parameters for the final arc solutions. Moreover, because of the new server, all the missing databases were downloaded from the IVS data centers in order to complete the IRA catalogue. In the meantime, databases

already analyzed and archived on HP workstations were copied to the Linux workstation and analyzed in order to create new Mark 5 Solve superfiles for global solutions.

Our Analysis Center has participated in the IVS TROP Project on Tropospheric Parameters since the beginning of the activities. Tropospheric parameters (wet and total zenith delay and horizontal gradients) of all IVS-R1 and IVS-R4 24-hour VLBI sessions were regularly submitted in the form of SINEX files. During the past year, due to several problems, we did not regularly submit results, but we continued our analysis in order to submit new Mark 5 solutions. We have computed a long time series of troposphere parameters using all VLBI sessions available in our catalogue in order to estimate the variations over time of the content of water vapor in the atmosphere.

### 3. Outlook

For the time being, our catalogue finally contains all available experiments. In 2009, using our new Linux workstation and the up-to-date Mark 5 Calc/Solve software, we plan to analyze all available databases, thus completing the catalogue. The regular submission of INAF tropospheric parameters to the IVS data centers will resume as soon as possible.

### References

- [1] Clark, T.A., P. Thomsen, Deformations in VLBI antennas, Technical Report: 100696, NASA, Greenbelt, MD.
- [2] Sarti, P., L. Vittuari, C. Abbondanza, Laser scanner and terrestrial surveying applied to gravitational deformation monitoring of large VLBI telescope's primary reflectors, in *Journal of Surveying Engineering* (*accepted*).



# JPL VLBI Analysis Center Report for 2008

*Chris Jacobs*

## Abstract

This report describes the activities of the JPL VLBI analysis center for the year 2008. We continue to do celestial reference frame, terrestrial reference frame, earth orientation, and spacecraft navigation work using the VLBI technique. There are several areas of our work that are undergoing active development. An important development was moving our earth orientation and reference frame work completely to Mark 5A recording and software correlation by the end of 2008. Our international collaboration to build celestial frames at K- (24 GHz) and Q-bands (43 GHz) matured to near a part-per-billion accuracy as documented in two submitted papers. Our in-house work to build a reference at X/Ka-bands (8.4/32 GHz) is also close to ppb accuracy. We supported the Phoenix Mars lander and other missions with VLBI navigation measurements. We continue to study ways to improve spacecraft tracking using VLBI techniques.

## 1. General Information

The Jet Propulsion Laboratory (JPL) analysis center is located in Pasadena, California. Like the rest of JPL, the center is operated by the California Institute of Technology under contract to NASA. JPL has had a VLBI analysis group since about 1970. Our work is focussed on supporting spacecraft navigation. This includes several components:

1. Celestial Reference Frame (CRF) and Terrestrial Reference Frame (TRF) are efforts that provide infrastructure to support spacecraft navigation and Earth orientation measurements.
2. Time and Earth Motion Precision Observations (TEMPO) measures Earth orientation parameters based on single baseline semi-monthly measurements. These VLBI measurements are then combined with daily GPS measurements as well as other sources of Earth orientation information. The combined product is used to provide Earth orientation for spacecraft navigation use.
3. Delta differenced one-way range ( $\Delta$ DOR) is a differential VLBI technique that measures the angle between a spacecraft and an angularly nearby extragalactic radio source. This technique thus complements the radial information from spacecraft doppler and range measurements by providing plane-of-sky information for the spacecraft trajectory.
4.  $\Delta$ VLBI phase referencing uses the VLBA to measure spacecraft positions.

## 2. Technical Capabilities

The JPL analysis center acquires its own data and supplements it with data from other centers. The data we acquire is taken using NASA's Deep Space Network (DSN).

1. Antennas: Most of our work uses 34 m antennas located near Goldstone (California, USA), Madrid (Spain), and Tidbinbilla (Australia). These include the following Deep Space Stations

(DSS): the “High Efficiency” subnet comprised of DSS 15, DSS 45, and DSS 65 (see Figure 1) which has been the most often used set of antennas for VLBI. More recently, we have been using the DSN’s beam waveguide (BWG) antennas: DSS 13, DSS 24, DSS 25, DSS 26, DSS 34, DSS 54, and DSS 55. Less frequent use is made of the DSN’s 70 m network (DSS 14, DSS 43, and DSS 63). Typical X-band system temperatures are 35K on the HEF antennas. The 70 m and BWGs are about 20K. Antenna efficiencies are typically well above 50% at X-band.

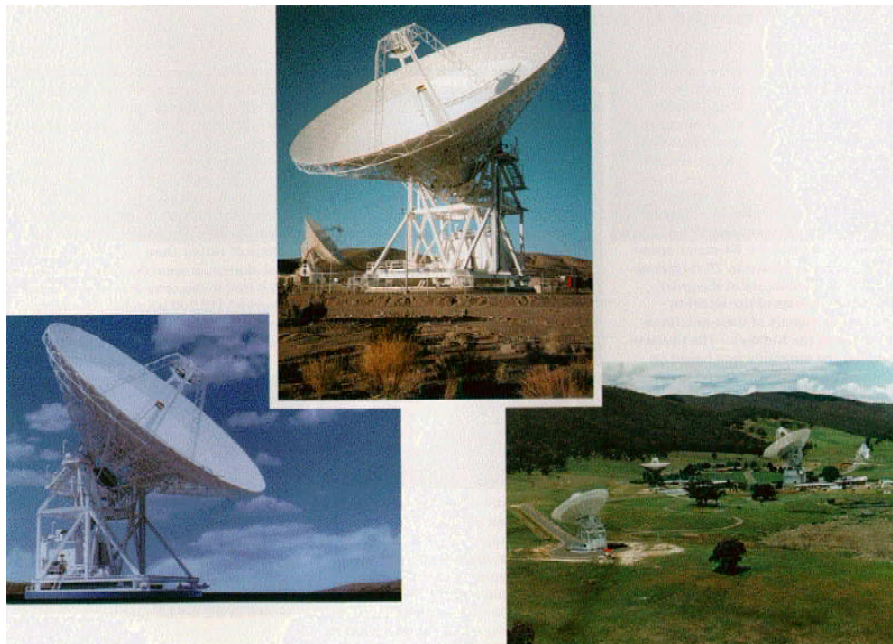

Figure 1. This figure shows the three high-efficiency antennas in the subnet: Goldstone is in the center; Robledo, Spain is on the lower left; and Tidbinbilla, Australia is on the lower right. These antennas were designed to have an optimum efficiency at X-band (8.4 GHz), which was to become the standard downlink frequency for solar-system exploration. An important secondary objective was to have a reasonable efficiency at Ka-band (32 GHz) thereby allowing for possible future use at the next highest band allocated for deep space communications. The subnet was completed in 1986 in time for the Voyager encounter with Uranus.

2. Data acquisition: The DSN’s Mark IV tape recorders and the BlockII tape-based correlator were retired during 2008 and were replaced by Mark 5A VLBI data acquisition systems and software correlation. In addition, we have JPL-unique systems called the VLBI Science Recorder (VSR) and the Wideband VSRs (WVSR) which have digital baseband converters and record directly to hard disk. The data is later transferred via network to JPL for correlation with our software correlator.
3. Correlators: JPL VLBI Correlation systems are now exclusively based on the SOFTC software which handles the  $\Delta$ DOR, TEMPO, and CRF correlations of disk format recordings. The VSRs and the software correlator have also been used for connected element interferometry tests of antenna arraying concepts.
4. Solution types: We run several different types of solutions. For  $\Delta$ DOR spacecraft tracking

we make narrow field ( $\approx 10^\circ$ ) differential solutions. The TEMPO solutions typically have a highly constrained terrestrial (TRF) and celestial frame (CRF) as a foundation for estimating Earth orientation parameters. These reference frames are produced from global solutions which then provide the framework needed for use by TEMPO and  $\Delta$ DOR.

### 3. Staff

Our staff are listed below with a brief indication of areas of concentration within the VLBI effort at JPL. Note that not all of the staff listed work on VLBI exclusively as our group is involved in a number of projects in addition to our VLBI work.

- Durgadas Bagri: antenna arraying and TEMPO.
- Jim Border:  $\Delta$ DOR spacecraft tracking.
- Mike Heflin:  $\Delta$ DOR, CRF, and TRF. Maintains MODEST analysis code.
- Chris Jacobs: TRF and S/X, K, Q, and X/Ka CRFs.
- Peter Kroger:  $\Delta$ DOR spacecraft tracking.
- Gabor Lanyi: VLBA phase referencing,  $\Delta$ DOR, WVR, K-Q CRF, and TRF.
- Steve Lowe: Software correlator and fringe fitting software.
- Walid Majid:  $\Delta$ DOR and VLBA phase referencing.
- Chuck Naudet: WVR, Mark 5A support, and K-Q CRF.
- Lyle Skjerve: Field support of VLBI experiments at Goldstone.
- Ojars Sovers: S/X, K, Q, and X/Ka CRFs and TRF. Maintains MODEST analysis code.
- Alan Steppe: TEMPO and TRF.
- L.D. Zhang: S/X, K and Q CRFs and TEMPO.

### 4. Current Status and Activities

In order to support the DSN's move to Ka-band (32 GHz), JPL is leading a collaboration with Goddard Space Flight Center, the U.S. Naval Observatory, National Radio Astronomical Observatory, and the Bordeaux Observatory to extend the ICRF to K-band (24 GHz) and Q-band (43 GHz). Results from the last seven years were summarized in papers submitted by Lanyi *et al* (2008) and Charlot *et al* (2008) for refereed publication. In-house work to build an X/Ka-band CRF has matured and was presented at international conferences (Jacobs & Sovers 2008; Jacobs 2008). We were also involved in the work to build the 2nd generation ICRF.

The advanced Water Vapor Radiometer (A-WVR) continues to be used in research applications. This device can calibrate water vapor induced delays to a fractional stability of roughly a few parts in  $10^{15}$  over time scales of 2,000 to 10,000 seconds and has demonstrated threefold reduction in VLBI residuals on time scales of 100 to 1000 seconds.

During 2008 we demonstrated that data taken at the maximum Mark 5A rate of 1024 Mbps could be processed by our software correlator. This data rate opens the door for a very high

sensitivity VLBI system when combined with the large apertures and low system temperatures of the DSN's antennas.

The highlight of 2008 was our successful support of the Mars Phoenix lander mission with VLBI-based navigation measurements.

## 5. Future Plans

In 2009, we expect to improve TEMPO and reference frame VLBI by increasing our Mark 5A recording rate to 512 Mbps—assuming that resources for recording media are approved. We plan to turn our prototype Ka-band phase calibrator into a set of operational units for operational deployment in 2010. Our next generation fringe fitting program is also expected to come online in the next year. We anticipate refereed publications on our high frequency celestial reference frame work. We plan to continue our involvement with the ICRF-2 team. On the spacecraft front, we plan to continue supporting a number of operational missions while further improving techniques for using VLBI for spacecraft tracking.

## 6. Acknowledgements

The work described here was in part performed at the Jet Propulsion Laboratory, California Institute of Technology, under contract with the National Aeronautics and Space Administration.

## References

- [1] Lanyi, G. E., D. Boboltz, P. Charlot, A. Fey, E. Fomalont, B. Geldzahler, D. Gordon, C. S. Jacobs, C. Ma, C. J. Naudet, J. Romney, O. J. Sovers, and L. D. Zhang, 'The Celestial Reference Frame at Higher Radio Frequencies. I. Astrometry from VLBA Observations at 24 and 43 GHz,' submitted to AJ, 21 Nov 2008.
- [2] Charlot, P., D. A. Boboltz, A. L. Fey, E. B. Fomalont, B. J. Geldzahler, D. Gordon, C. S. Jacobs, G. E. Lanyi, C. Ma, C. J. Naudet, J. D. Romney, O. J. Sovers, and L. D. Zhang, 'The Celestial Reference Frame at Higher Radio Frequencies. II. VLBA Imaging at 24 and 43 GHz,' submitted to AJ, 21 Nov 2008.
- [3] Jacobs, C. S., and O. J. Sovers, 'Extending the ICRF to Higher Radio Frequencies: Global Astrometric Results at 32/8 GHz,' IVS 2008 General Meeting Proceedings, A. Finkelstein and D. Behrend, eds. Session 4-08, St. Petersburg, Russia, 04 March 2008, <ftp://ivscc.gsfc.nasa.gov/pub/general-meeting/2008/pdf/jacobs.pdf>
- [4] Lanyi, G. E., D. Boboltz, P. Charlot, A. Fey, E. Fomalont, B. Geldzahler, D. Gordon, C.S. Jacobs, C. Ma, C. J. Naudet, J. Romney, O. J. Sovers, and L. D. Zhang, 'Astrometry from VLBA Observations at 24 and 43 GHz,' IVS 2008 General Meeting Proceedings, A. Finkelstein and D. Behrend, eds. Session 4-09P, St. Petersburg, Russia, 04 March 2008, <ftp://ivscc.gsfc.nasa.gov/pub/general-meeting/2008/pdf/lanyi.pdf>
- [5] Jacobs, C. S., 'Extending the ICRF to Higher Radio Frequencies: 24, 32, & 43 GHz Global Astrometry,' Journees 2008 Proceedings, Session 5, Dresden, Germany, 24 Sep 2008, <http://astro.geo.tu-dresden.de/journees2008/programme.htm>

# KASI Combination Center Report

*Jungho Cho, Younghee Kwak*

## Abstract

This report introduces the Korea Astronomy and Space Science Institute (KASI) and describes the planned activities of the KASI as an IVS Combination Center.

## 1. General Information

The proposal of the Korea Astronomy and Space Science Institute (KASI) for becoming an IVS combination center was accepted on October 21, 2008. KASI is one of the affiliated organizations of IVS.

KASI Headquarters is located in the Daeduk research and development complex, Daejeon. The Space Geodesy research of KASI was started in 1992 with GPS. Now the KASI Space Geodesy research division is composed of three groups including the Earth Observing System (EOS) research group. The EOS research areas are based on Space Geodetic techniques such as GNSS, VLBI, SLR and Gravimeter and are focused on the changes of the Earth's shape and its geodynamics. The EOS research group also works on the applications of Space Geodesy such as an early warning system of natural hazards. The EOS group will be in charge of an IVS combination center as an extension of research on the Earth's shape changes.



Figure 1. KASI Headquarters

## 2. Personnel

Table 1. Personnel at the KASI Combination Center

Jungho Cho	+82-42-865-3234	jojh@kasi.re.kr
Younghee Kwak	+82-42-865-2031	bgirl02@kasi.re.kr
Jooyeon Lim(from March 16, 2009)	+82-42-865-2134	milkyway1275@kasi.re.kr

## 3. Future Plans

The KASI combination center is considering using ADDNEQ, a subprogram of the Bernese software that is one of the prevailing GPS data processing and analysis tools. KASI has had long experience with using the Bernese software package since the middle of the 90's and has been equipped with Bernese 5.0.

As the first task, we will investigate the algorithm and the structure of the ADDNEQ program to see whether it can properly be applied to geodetic VLBI purposes. If necessary, we may have to obtain the approval of the Astronomical Institute, University of Bern (AIUB) for the modification of ADDNEQ subroutines for application to VLBI combination.

After the arrangement of ADDNEQ, we will produce preliminary combination results and prepare the following functions described in our proposal as an IVS combination center.

- Perform quality control of the Analysis Center results
- Provide feedback to the Analysis Centers
- Create high quality combination products and perform timely archiving and distribution
- Generate official IVS input to the ITRF
- Adhere to the IERS Conventions

After consultation with the IVS Analysis Coordinator during the preparation period, KASI's duties will be finally fixed.

# IVS Analysis Center at Main Astronomical Observatory of National Academy of Sciences of Ukraine

*Sergei Bolotin, Svitlana Lytvyn, Yaroslav Yatskiv*

## Abstract

This report summarizes the activities of the VLBI Analysis Center at the Main Astronomical Observatory of the National Academy of Sciences of Ukraine in 2008.

## 1. Introduction

The VLBI Analysis Center was established in 1994 by the Main Astronomical Observatory (MAO) of the National Academy of Sciences of Ukraine (NASU) as a working group of the Department of Space Geodynamics of the MAO. In 1998 the group started its IVS membership as an IVS Analysis Center. The AC MAO is located in the Central office of the observatory in Kiev.

## 2. Technical Description

VLBI data analysis at the center is performed on two computers: an Intel Core 2 Duo 3.1 GHz box with 4 Gb RAM and a 1 TB HDD, and a Pentium-4 3.4 GHz box with 1 GB RAM and two 200 GB HDDs. Both computers are running under the Linux/GNU Operating System.

The Main Astronomical Observatory improved its Internet connection in 2007. Now we have a 10 Mbps fiber channel with a 256 kbps backup on a leased line.

For data analysis we use the STEELBREEZE software which was developed at the MAO NASU. The STEELBREEZE software is written in the C++ programming language and uses the Qt widget library. STEELBREEZE makes Least Squares estimation of different geodynamical parameters with the Square Root Information Filter (SRIF) algorithm (see [1]).

The software analyzes VLBI data (time delay) of a single session or a set of multiple sessions. The time delay is modeled according to the IERS Conventions (2003) [2], as well as by using additional models (tectonic plate motion, nutation models, wet and hydrostatic zenith delays, mapping functions, etc). The following parameters are estimated: Earth orientation parameters, coordinates and velocities of a selected set of stations, coordinates of a selected set of radio sources, clock function and wet zenith delay.

## 3. Staff

The VLBI Analysis Center at Main Astronomical Observatory consists of three members:

**Yaroslav Yatskiv:** Head of the Department of Space Geodynamics; general coordination and support of activity of the Center.

**Sergei Bolotin:** Senior research scientist of the Department of Space Geodynamics; responsible for the software development and data processing.

**Svitlana Lytvyn:** Engineer of the Department of Space Geodynamics; investigates the stability of VLBI-derived celestial and terrestrial systems.

## 4. Current Status and Activities in 2008

In 2008 we performed regular VLBI data analysis to determine Earth orientation parameters. “Operational” solutions were produced and submitted to the IVS on a weekly basis. The IERS Conventions (2003) [2] models have been applied in the analysis. In the solutions, coordinates of stations and Earth orientation parameters are estimated.

Also, this year we continued to participate in the IVS Tropospheric Parameters project. Estimated wet and total zenith delays for each station were submitted to IVS. The analysis procedure was similar to the one used for the operational solutions.

In the frame of preparing the next ICRF realization, the center produced global CRF solution `mao005a`. The catalog is based on the analysis of almost all available dual-band VLBI observations from 1979.08.03 to 2008.09.29, which are usable for the simultaneous determination of TRF, CRF, and EOP. In total, 6,599,550 observations acquired from 3,850 VLBI sessions were processed. Coordinates of radio sources and positions of stations and velocities were estimated as global parameters; EOP were estimated as local parameters; clock function and tropospheric parameters (zenith delay and its gradients) were treated as stochastic parameters (random walk model). The CRF solution consists of coordinates of 1,151 radio sources.

For the same set of VLBI sessions, time series of radio source coordinate variations were estimated. For this solution, `mao006a`, we applied the results from previous global solution `mao005a` to obtain initial coordinates and velocities of stations, source positions, and EOP. Coordinates of radio sources were estimated as local parameters. Clock functions and tropospheric parameters were estimated as stochastic parameters (random walk model).

Also, a combined catalog `maoC05b` has been created. The solution is based on individual solutions of six VLBI Analysis Centers (GSFC, IAA, MAO, OPAR, SHAO and USNO) which have participated in the ICRF2 project. The Kiev arc method was used for constructing the combined catalog.

## 5. Plans for 2009

The MAO Analysis Center will continue to participate in operational EOP determination as well as updating the solutions of TRF and CRF from VLBI analysis of the full data set of observations.

## Acknowledgments

The work of our Analysis Center would be impossible without the activities of other components of IVS. We are grateful to all contributors of the Service.

## References

- [1] Biermann, G.J., 1977, Factorization Methods for Discrete Sequential Estimation, V128, Mathematics in Science and Engineering Series, Academic Press.
- [2] IERS Conventions (2003), IERS Technical Note 32, eds. D.D. McCarthy and G. Petit, Bundesamt für Kartographie und Geodäsie, Frankfurt am Main.



# Analysis Center at National Institute of Information and Communications Technology

*Thomas Hobiger, Hiroshi Takiguchi, Ryuichi Ichikawa, Mamoru Sekido, Yasuhiro Koyama, Tetsuro Kondo*

## Abstract

This report summarizes the activities of the Analysis Center at the National Institute of Information and Communications Technology (NICT) for the year 2008.

## 1. General Information

The NICT Analysis Center is located in Kashima, Ibaraki, Japan and is operated by the space-time standards group of NICT. Analysis of VLBI experiments and related study fields at NICT are mainly concentrated on experimental campaigns for developing new techniques such as e-VLBI for real-time EOP determination, prototyping of a compact VLBI system, time and frequency transfer, atmospheric path delay studies, and improvement of the accuracy of space geodetic techniques.

## 2. Staff

Members who are contributing to the Analysis Center at the NICT are listed below (in alphabetical order):

- HOBIGER Thomas, Atmospheric and ionospheric research using VLBI and GPS, and studies on the improvement of the accuracy of space geodetic techniques
- ICHIKAWA Ryuichi, Compact VLBI system development and atmospheric modeling
- KONDO Tetsuro, Software correlator
- KOYAMA Yasuhiro, International e-VLBI
- SEKIDO Mamoru, International e-VLBI and VLBI for spacecraft navigation
- TAKIGUCHI Hiroshi, Time-transfer experiments, international e-VLBI, and loading effects

## 3. Current Status and Activities

### 3.1. Ultra-rapid UT1 Experiments

Data transfer via Internet protocols allows reduction of the latency of UT1 measurements obtained from VLBI. Such experiments, known as e-VLBI, were conducted in cooperation with colleagues from Metsähovi, Onsala, Wettzell, and GSI in order to demonstrate that the estimates of UT1 can be obtained shortly after the last scan has been observed [6]. By the usage of the UDP-based Tsunami protocol, data were sent to Kashima, converted to K5 format, and handed over to our software correlator, which is operated in distributed computing mode. In cooperation with Geographical Survey Institute (GSI) it was possible to obtain UT1 estimates, which have been proven to be as accurate as the IERS Bulletin-A results, as soon as three minutes after the last observation has been made. The experience gained from these experiments is going to be

applied to the weekly intensive VLBI sessions and is expected to improve the latency and accuracy of the IERS products.

### 3.2. MARBLE

We are developing a compact VLBI system with a 1.6 m diameter aperture dish in order to provide reference baseline lengths for calibration. The 10-km reference baselines are used to validate surveying instruments maintained by GSI, such as GPS and EDM. The compact VLBI system will be installed at both ends of the reference baseline. We named the system "Multiple Antenna Radio-interferometry of Baseline Length Evaluation (MARBLE)" [5]. We have tested the front-end of the compact VLBI system with a wide-band quad-ridged horn antenna (QRHA) before installing it on the 2.4 m diameter dish at Kashima. We performed three single-band and two geodetic (S/X) VLBI experiments on a 54 km baseline between the 2.4 m dish equipped with the QRHA and the Tsukuba 32 m antenna of GSI (see Figure 1). The results of the determined baseline length agree well with experiments which used only an X-band feed on the 2.4 m dish.

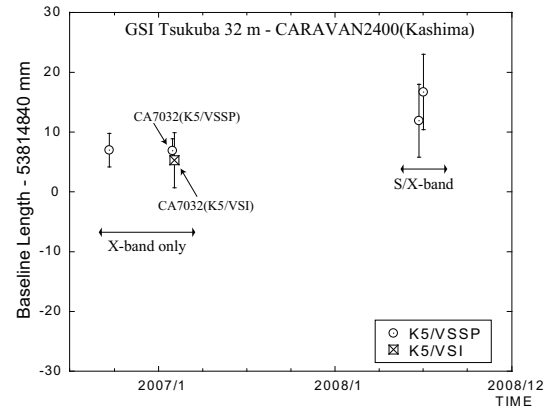

Figure 1. Results of experiments using the QRHA on a 2.4 m antenna.

### 3.3. Time and Frequency Transfer via VLBI

We are planning to use MARBLE for time and frequency transfer, as one of its applications. In order to confirm the potential of current VLBI time and frequency transfer, we have compared the results of VLBI and GPS carrier phase frequency transfer using the Kashima-Koganei baseline. First results revealed that VLBI is more stable than GPS [7]. Also, we compared VLBI and GPS using data from the IVS and the International GNSS Service (IGS) for the same purpose. The results of the VLBI frequency transfer show that the stability follows a  $1/\tau$  law very closely, and it surpasses the stability of atomic fountains at  $10^3$  seconds or longer. Moreover, it could be shown that the stability has reached about  $2 \times 10^{-11}$  (20 ps) at 1 second. These results verify that the geodetic VLBI technique has the potential for precise frequency transfer [8].

### 3.4. MK3TOOLS

A set of programs, summarized under the name MK3TOOLS, allows the creation of Mark III databases from post-correlator output without any dependency on CALC/SOLVE libraries. NetCDF files are utilized as intermediate data storage, and either Mark III compatible databases or NGS files are generated for follow-on analysis. Since all routines can be controlled from the command line, MK3TOOLS enables the realization of a processing chain without human interactions and allows the generation of databases for applications with a high demand for low latency (e.g. e-VLBI). In interactions with OCCAM, MK3TOOLS is capable of automatically resolving ambiguities and computing ionosphere-free observables from dual-frequency experiments.

### 3.5. Kashima Ray-tracing Tools—KARAT

For all space geodetic techniques operating with radio frequency signals that are emitted outside the Earth's atmosphere, delays caused by the troposphere have to be considered properly in order to remove bias from the arrival times of the incoming signals. Since the troposphere constituents, and thus the index of refraction, are highly variable with time and space, it is common to estimate troposphere delays within space geodetic analysis rather than modeling its effect a priori. As numerical weather models have been constantly improved with respect to their accuracy and resolution, it has become feasible to utilize them for the purpose of computing troposphere delay corrections from ray-tracing [2], considering that residual delays are still estimated within the geodetic adjustment process. Kashima has developed a software package named Kashima Ray-tracing Tools (KARAT) that is able to transform numerical weather model data sets to geodetic reference frames, compute fast and accurate ray-traced slant delays [1], and correct geodetic data on the observation level. Currently VLBI and GPS, as well as InSAR observations, can be corrected for atmosphere path delays by KARAT.

### 3.6. Kashima Ray-tracing Service—KARATS

In order to enable users of space geodetic techniques to take advantage of KARAT without the need to access numerical weather models on their own, it was decided to provide ray-tracing as a service. Thus the ray-tracing tools will be embedded in an automated processing chain, called Kashima Ray-Tracing Service (KARATS), which can be started via a Web interface. Once a user has taken his observations, he can send the data in a common format via the Internet to KARATS. Then the Web server will do a rough data check and compute the geometry from the observation file. As soon as a ray-tracing client becomes available, the server will send the geometry file to that machine. The client performs the ray-tracing and sends the tropospheric delays back to the server. Then the ray-traced delays are subtracted from the user's data and a "reduced" observation file is sent back to the user. KARATS will be free of charge and is currently undergoing a beta-test phase before it is opened to the public.

### 3.7. Phase Ambiguity Resolution Within Next-generation VLBI

For next-generation VLBI systems, it is necessary not only to deploy improved technology, but also to revise analysis strategies to take full advantage of the observations taken. With the new systems, it should be feasible to resolve phase ambiguities directly from post-correlation data, providing roughly an order of magnitude improvement in the precision of the delay observable. As the unknown ambiguities are of integer nature, methods of analytically resolving them have been investigated [4]. Furthermore, it has been shown that other nuisance parameters can be solved simultaneously with the analytically relevant delay observables.

### 3.8. Effect of Formatter Clock Offsets on UT1 Estimates from INT2 Sessions

INT2 observation networks are equipped with different hardware components, which require different processing strategies when the data are correlated. As the timing units at each station are usually offset with respect to universal time (UTC), this effect should be considered during correlation processing. Thus, the theoretical impact of neglecting these offsets on the estimation of UT1 has been investigated. Moreover, studies have been made into how formatter clock offsets

affect UT1 time series and how such missing corrections can be applied a posteriori [3]. Although the discussed effect is smaller than the formal error of the estimates for most of the UT1 experiments, it is important to consider station clock offsets properly in next-generation VLBI systems, which are expected to improve the accuracy of the results by about one order of magnitude.

#### 4. Future Plans

For the year 2009 the plans of the Analysis Center at NICT include:

- Several international and domestic VLBI experiments for real-time EOP determination using e-VLBI and the K5 system
- Further development of the automated processing of UT1 experiments and extension of the processing to multi-baseline experiments
- Time and frequency transfer experiments
- Opening KARATS for public use and further development of troposphere ray-tracing methods
- Differential VLBI experiments for spacecraft tracking and their analysis
- Improvement of processing speed and efficiency of the VLBI data correlation using multi-processors and high-speed networks

#### References

- [1] Hobiger T., R. Ichikawa, Y. Koyama, and T. Kondo, Fast and accurate ray-tracing algorithms for real-time space geodetic applications using numerical weather models, *J. Geophys. Res.*, 113, D20302, 2008.
- [2] Hobiger T., R. Ichikawa, T. Takasu, Y. Koyama, and T. Kondo, Ray-traced troposphere slant delays for precise point positioning, *Earth, Planets and Space*, 60(5), e1-e4, 2008.
- [3] Hobiger T., Y. Koyama, J. Boehm, T. Kondo, and R. Ichikawa, The effect of neglecting VLBI reference station clock-offsets on UT1 estimates, *Advances in Space Research*, in press, 2009.
- [4] Hobiger T., M. Sekido, Y. Koyama, and T. Kondo, Integer phase ambiguity estimation in next-generation geodetic Very Long Baseline Interferometry, *Advances in Space Research*, 43(1), 187-192, 2009.
- [5] Ichikawa R., A. Ishii, H. Takiguchi, H. Kuboki, M. Kimura, J. Nakajima, Y. Koyama, T. Kondo, M. Machida, S. Kurihara, K. Kokado, and S. Matsuzaka, Development of a Compact VLBI System for Providing over 10-km Baseline Calibration, "Measuring The Future", *Proceedings of the Fifth IVS General Meeting*, 400-404, 2008.
- [6] Sekido M., H. Takiguchi, Y. Koyama, T. Kondo, R. Haas, J. Wagner, J. Ritakari, S. Kurihara, and K. Kokado, Ultra-rapid UT1 measurements by e-VLBI, *Earth, Planets and Space*, 60(8), 865-870, 2008.
- [7] Takiguchi H., Y. Koyama, R. Ichikawa, T. Gotoh, A. Ishii, T. Hobiger, and M. Hosokawa, VLBI measurements for time and frequency transfer, *EFTF 2008 Proceedings*, 2008.
- [8] Takiguchi H., Y. Koyama, R. Ichikawa, T. Gotoh, A. Ishii, T. Hobiger, and M. Hosokawa, Comparison Study of VLBI and GPS Carrier Phase Frequency Transfer using IVS and IGS data, *IVS NICT-TDC News*, No.29, 23-27, 2008.

# Paris Observatory Analysis Center OPAR: Report on Activities, January - December 2008

*Anne-Marie Gontier, Sébastien B. Lambert, Christophe Barache*

## Abstract

We report on activities of the Paris Observatory VLBI analysis center (OPAR) for calendar year 2008. Among the main issues is the inclusion of OPAR solutions in the IVS rapid solution. We also summarize various scientific results concerning the stabilization of the celestial reference frame, the determination of the dissipative factor associated with the Earth's fluid core by the use of VLBI and superconducting gravimeters, improvements in the theory of nutation and precession, and the determination of the relativistic parameter  $\gamma$  from VLBI delays. OPAR continuously publishes results from routine analysis on its Web site <http://ivsopar.obspm.fr>.

## 1. Developments at OPAR

### 1.1. Operational Status

OPAR personnel continued to produce quarterly global solutions every three months. The corresponding Earth orientation parameter (EOP) time series were submitted to the IVS. A radio source coordinate catalogue and station coordinates and velocities were made available through the Web site. These solutions differ from other analysis centers' by the use of the 247 stable sources of Feissel-Vernier et al. (2006) as defining sources instead of the 212 ICRF defining sources as provided by Ma et al. (1998). EOP series were updated by new data as soon as new experiment data bases were released. Daily SINEX files for IVS R1 and R4 experiments were generated and submitted to the IVS. UT1 series from intensives starting in April 2006 were maintained and aligned to the ITRF 2005. Polar motion is forced by the IERS EOP 05 C 04 series. Radio source coordinate time series were updated every three months. Our Web site provides plots for sources having a reasonable number of observations.

### 1.2. Working Groups

OPAR members are involved in various working groups. A.-M. Gontier is a member of the IVS WG 4 and of the IAG WG 1.4.1. S. B. Lambert is chair of the IAG WG 1.4.3. Both are members of the IVS/IERS WG on the Second Realization of the ICRF.

### 1.3. Virtual Observatory and VOTable Data Format

[8] summarizes the French activities in the frame of the astronomical and geodetic Virtual Observatory (VO), an international proposal that provides uniform, convenient access to disparate, geographically dispersed archives of astronomical data from software which runs on the computer on the astronomer's desktop. VOTable is an XML-based format for representing astronomical data, and that takes advantage of computer-industry standards and uses standard software and tools. VO standards had initially been developed for Earth-centered or body-centered reference frames in order to extend the VO to Earth and planetary sciences. Nevertheless, some improvements had to be made to adapt the existing VO to geodesy. We recently proposed to the International Virtual Observatory Alliance (IVOA) the adoption of new standards relevant to the Earth orientation

data. OPAR products are now provided in VOTable format using these new standards. This includes terrestrial and celestial reference frames, station and radio source coordinate time series, and EOP. Thanks to the VOTable format, the latter can directly be viewed in the VO-designed software Aladin (<http://aladin.u-strasbg.fr>) with which various operations can be done in a few clicks (cross-identifications, superimposition of optical images, etc.). In addition, a page that allows one to locate the observing antennas used in OPAR solutions using Google Earth has been released. Visit <http://ivsopar.obspm.fr/vo> to learn more.

## 2. Research Activities Involving OPAR

### 2.1. Towards the ICRF2

We actively participated in IVS WG 4 analyses. We attended the Saint-Petersburg and Dresden meetings. We developed existing and new tools to assess rotations and deformations of submitted catalogues with respect to the ICRF-Ext.2 [5], to make vectorial harmonics decomposition of these catalogues and comparative analysis of the submitted time series. Results of these analyses were made available to the working group members.

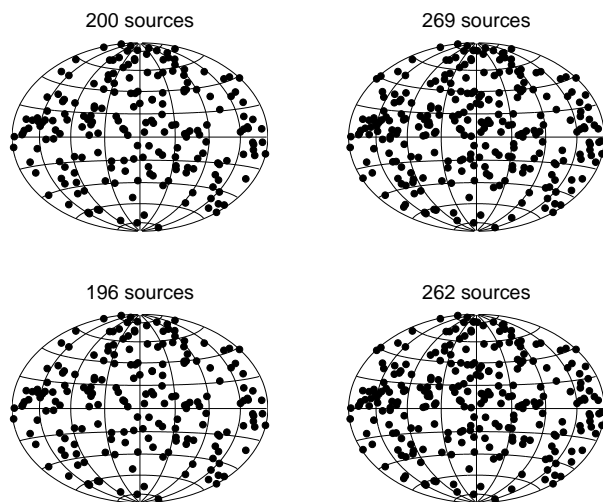

One of the goals of the next ICRF realization is to obtain a set of defining sources that is definitely more stable in time than the current 212 defining sources of the ICRF ([15]). In [6], we already presented a simple scheme, partly inspired by the work of [4], to obtain a set of core sources reaching this goal. In [12], we improved the selection algorithm and applied it to source coordinate time series obtained from the analysis of 26 years of VLBI observations.

Figure 1. Distribution of the source subsets considered in [12].

The selection criterion considered the positional rms, the slope, and the observational history of the sources. We obtained four frames made of 196, 200, 262, and 269 sources, respectively, showing a satisfactory sky coverage in both hemispheres (Fig. 1). Our selections provide a frame stability improved by up to 40% with respect to the ICRF, and by 20% with respect to [4]. Reanalysis of data with respect to this frame gives astrometric catalogues aligned to the ICRF-Ext.2 within  $17 \mu\text{as}$ . Effects on EOP estimates and terrestrial reference frame determination remain marginal.

### 2.2. Earth's Interior

Observation of the Earth's nutation allows one to determine some properties of the Earth's internal layers. In 2007, we examined whether the VLBI analysis configuration to produce EOP could have a substantial impact on determinations of the free core nutation (FCN) and free inner core nutation (FICN) frequencies ([9]) that describe the free rotation modes of the fluid outer core and of the solid inner core, respectively. We concluded that the instability of the celestial

reference frame could force one to constrain the FCN and FICN at better than 0.1 day and 100 days, respectively, which is smaller than the error that arises from the internal noise of the EOP series. In 2008, we focused on the dissipation at the core-mantle boundary (CMB) that shows up observationally in the quality factor  $Q$  of the FCN (i.e., imaginary part of the FCN frequency). The dissipation factors estimated from VLBI nutation data and from local tidal displacement measured by superconducting gravimeters were known to be in disagreement, the latter being about 30% smaller than the former, leaving open questions about the values of possible dissipative torques emerging from electromagnetic or topographic couplings at the CMB. After a wise treatment of gravimetric data (especially concerning the ocean loading correction) and the use of optimized estimation methods, we got a value close to  $Q \sim 16\,000$  for both techniques ([17, 18]).

### 2.3. Theory of the Earth's Nutation and Precession

Theoretical formulation of the second-order contribution to the nutation of the interaction between the tidal potential and the tides arising at the Earth's surface ([7]) has been reexamined for the precession part ([11]), and extended to the axial rotation of the planet ([14]). Note that the additional terms, which emerge mainly from dissipation processes in the oceans, are at the level of current VLBI observational accuracy.

Figure 2. Nutation offsets with respect to IAU 2006 after removal of the FCN.

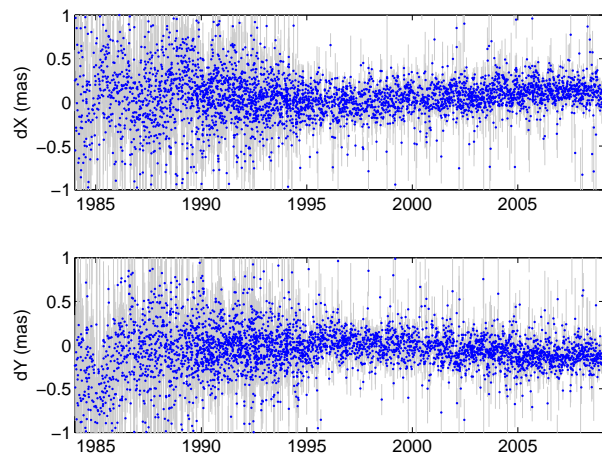

Fundamental aspects of the semi-analytical precession-nutation models that were adopted by IAU Resolutions in 2000 and 2006 ([16, 1]) were discussed in [2, 3]. In these studies, we also reported on the most recent comparisons of the models with VLBI observations (Fig. 2). We showed that a combination of linear and 18.6-year corrections is the most credible model for explaining the currently observed residuals, but that a longer span of observations is required before the true character of the effect can be determined.

### 2.4. Test of Relativity

Relativistic bending in the vicinity of a massive body is characterized by the post-Newtonian parameter  $\gamma$  within the standard parameterized post-Newtonian formalism, which is unity in General Relativity. We retrieved  $\gamma$  from the analysis of geodetic VLBI observations recorded since 1979. We compared estimates of  $\gamma$  and errors obtained using various analysis schemes including global estimations over several time spans and with various Sun elongation cut-off angles, and analysis of radio source coordinate time series. We concluded that  $\gamma$  cannot be estimated at better than  $2 \times 10^{-4}$ . The main factor of limitation is the uncertainty in the determination of radio source coordinates. A sum of various instrumental and modeling errors and analysis strategy defects, that cannot be decorrelated and corrected yet, is at the origin of the limiting noise ([10, 13]).

## References

- [1] Capitaine, N., Wallace, P. T., & Chapront, J. 2003, Expressions for IAU 2000 precession quantities, *A&A*, 412, 567
- [2] Capitaine, N., Mathews, P. M., Dehant, V., et al. 2008, Comparisons of precession-nutation models, In: A. Finkelstein and D. Behrend (Eds.), *IVS 2008 General Meeting Proc.*, 221
- [3] Capitaine, N., Mathews, P. M., Dehant, V., et al. 2009, On the IAU 2000/2006 precession-nutation and comparison with other models and VLBI observations, *Celest. Mech. Dyn. Astr.*, 103, 179
- [4] Feissel-Vernier, M., Ma, C., Gontier, A.-M., & Barache, C. 2006, Analysis strategy issues for the maintenance of the ICRF axes, *A&A*, 452, 1107
- [5] Fey, A. L., Ma, C., Arias, E. F., et al. 2004, The Second Extension of the International Celestial Reference Frame: ICRF-EXT.1, *AJ*, 127, 3587
- [6] Gontier, A.-M., & Lambert, S. B. 2008, Stable radio sources and reference frame, In: N. Capitaine (Ed.), *Proc. Journées 2007 systèmes de référence spatio-temporels*, Observatoire de Paris, 42
- [7] Lambert, S. B., & Mathews, P. M. 2006, Second-order torque on the tidal redistribution and the Earth's rotation, *A&A*, 453, 363
- [8] Lambert, S. B., Deleflie, F., Gontier, A.-M., Bério, P., & Barache, C. 2008, The astronomical Virtual Observatory and application to Earth's sciences, In: A. Finkelstein and D. Behrend (Eds.), *IVS 2008 General Meeting Proc.*, 203
- [9] Lambert, S. B., Dehant, V., & Gontier, A.-M. 2008, Celestial frame instability in VLBI analysis and its impact on geophysics, *A&A*, 481, 535
- [10] Lambert, S. B., & Le Poncin-Lafitte, C. 2008, An estimate of the relativistic parameter  $\gamma$  using VLBI, In: A. Finkelstein and D. Behrend (Eds.), *IVS 2008 General Meeting Proc.*, 341
- [11] Lambert, S. B., & Mathews, P. M. 2008, Erratum. Second-order torque on the tidal redistribution and the Earth's rotation, *A&A*, 481, 833
- [12] Lambert, S. B., & Gontier A.-M. 2009, On radio source selection to define a stable celestial frame, *A&A*, 493, 317
- [13] Lambert, S. B., & Le Poncin-Lafitte, C. 2009, Determination of the relativistic parameter  $\gamma$  using very long baseline interferometry, *A&A*, submitted
- [14] Mathews, P. M., & Lambert, S. B. 2009, *A&A*, Effect of mantle and ocean tides on the Earth's rotation rate, 493, 325
- [15] Ma, C., Arias, E. F., Eubanks, T. M., et al. 1998, The International Celestial Reference Frame as Realized by Very Long Baseline Interferometry, *AJ*, 116, 516
- [16] Mathews, P. M., Herring, T. A., & Buffett, B. A. 2002, Modeling of nutation and precession: New nutation series for nonrigid Earth and insights into the Earth's interior, *J. Geophys. Res.*, 107(B4), 10.1029/2001JB000390
- [17] Rosat, S., & Lambert, S. B. 2008, Outer and inner core parameters from joint analysis of superconducting gravimeter and VLBI data, In: A. Finkelstein and D. Behrend (Eds.), *IVS 2008 General Meeting Proc.*, 246
- [18] Rosat, S., & Lambert, S. B. 2009, Sensitivity of surface gravity and nutation to the Earth's interior: analysis of the FCN resonance parameters, *A&A*, submitted



# Onsala Space Observatory – IVS Analysis Center

*Rüdiger Haas, Hans-Georg Scherneck, Tobias Nilsson*

## Abstract

We briefly summarize the activities of the IVS Analysis Center at the Onsala Space Observatory during 2008 and give examples of results of ongoing work.

## 1. Introduction

We concentrate on a number of research topics that are relevant for space geodesy and geosciences. These research topics are addressed in connection to data observed with geodetic VLBI and complementing techniques. Some topics are briefly presented in the following.

## 2. Analysis of the CONT08 Campaign

We started to analyze the VLBI databases of the CONT08 campaign. Unfortunately, only 5 of the 15 CONT08 experiments were correlated by the end of 2008. For one of these experiments the Onsala Mark 5 disk-module did not arrive at the Washington correlator in due time, so that the Onsala data have not been correlated yet and are not included in the corresponding VLBI database. Thus, only four CONT08 experiments with Onsala could be analyzed so far. In a first step we concentrated on the atmospheric path delays and compared the zenith wet delay (ZWD) results derived from the co-located techniques at Onsala, i.e. VLBI, GPS, and the microwave radiometers Astrid and Konrad, and radiosondes launched at the Landvetter airport, see Figure 1.

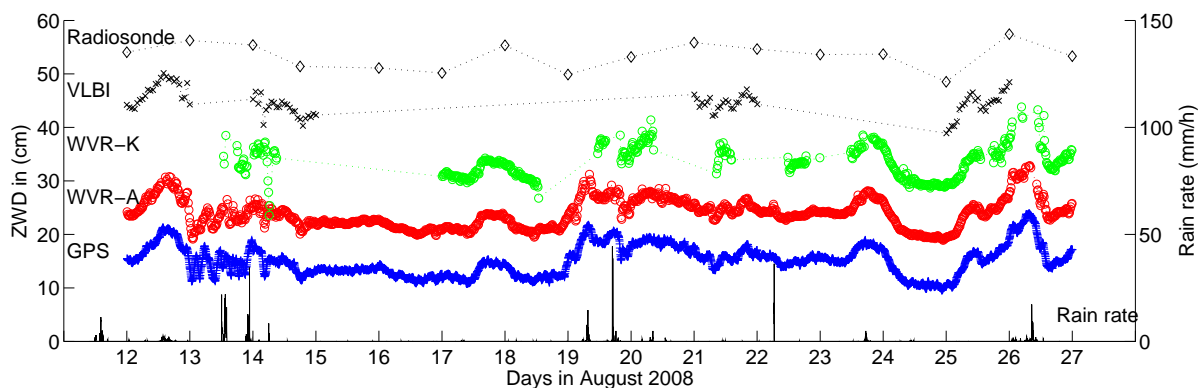

Figure 1. Time series of zenith wet delay (ZWD) and rain rate for Onsala during CONT08. Shown are ZWD results from GPS (blue plus signs), the microwave radiometers Astrid (WVR-A, red circles) and Konrad (WVR-K, green circles), VLBI (black crosses), and radiosonde observations at Landvetter airport (black diamonds). To improve readability, the results are shown with offsets of +10 to +40 cm with respect to the GPS results that are shown on the correct level. Rain rate observations are displayed in black at the bottom of the figure and refer to the right scale.

This preliminary analysis shows biases in the ZWD results of about  $-12$  mm between the the microwave radiometer Astrid and GPS,  $-10$  mm between VLBI and GPS, and  $+1$  mm between VLBI and the microwave radiometer Astrid. The analysis will be continued and extended as soon as the still missing VLBI databases for CONT08 become available. Then we will also investigate high-frequency variations of the Earth rotation and orientation parameters.

### 3. Local Tie Measurements at Onsala

In September 2008 we performed measurements to determine the reference point of the 20 m radio telescope and the local tie between the reference points of the VLBI and GNSS monuments [1]. This project was performed in collaboration with the Institute for Geodesy and Geoinformation at the University of Karlsruhe, Germany. The measurements were done with a laser tracker and cat-eye reflectors that were mounted on the telescope cabin and reference markers in the local network. Figure 2 shows pictures taken during the measurement campaign. The data were analyzed with a new analysis approach [2], and the reference point of the telescope and the local tie were determined with complete covariance matrices. The results agree on the sub-millimeter level with the results of the previous local tie measurements performed in 2002 [3].



Figure 2. Left: the laser tracker mounted on a survey pillar inside the radome building of the 20 m telescope. Right: cat-eye reflectors mounted on the telescope cabin.

### 4. Local Tie Analysis for Yebes

In a collaboration with Susana Garcia Espada from the National Geographic Institute of Spain, we investigated the local tie between the VLBI and GNSS reference points at Yebes. For this purpose we reanalyzed the European VLBI databases and determined time series of the station position of the 14 m radio telescope at Yebes (Spain) with respect to ITRF2005. Additionally we analyzed for the same period of time the GPS data observed with the co-located IGS station at Yebes. For this analysis we used the Gipsy-Oasis-II software package and applied the precise point positioning strategy. After subtraction of a plate motion model we determined the baseline length between the IVS and IGS reference points at Yebes, see Fig. 3. The results appear to indicate a

local movement between these two reference points [4]. Further investigations are necessary.

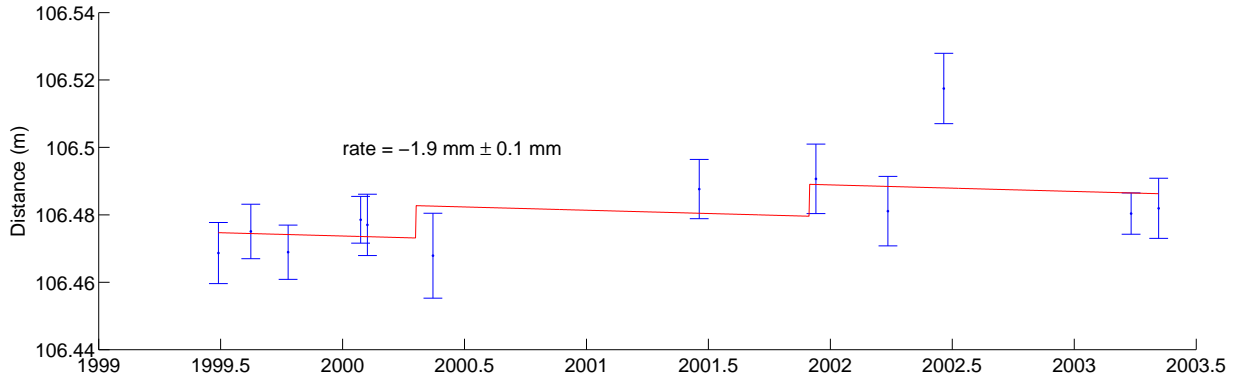

Figure 3. Time series of the relative distance between the VLBI and GPS reference points at Yebes.

### 5. Tropospheric Delays for VLBI2010 Simulations

During 2008 we continued to contribute with determination of equivalent zenith wet delays [5] to the simulations for the VLBI2010 project [6]. One of the most critical parameters for these simulations is the turbulence parameters  $C_n^2$  and its temporal and spatial variation. The  $C_n^2$  parameter can be derived, for example, from high-resolution radiosonde profiles. However, such data are only available for specific launch sites that in general do not coincide with existing or planned VLBI sites. Figure 4 shows mean and median profiles of the turbulence parameter  $C_n^2$  for three sample radiosonde launch sites for the year 2005. In order to ensure realistic simulations of equivalent zenith wet delays, more work is needed to evaluate the reliability of these turbulence parameters and to develop models that allow them to be related to different epochs and locations.

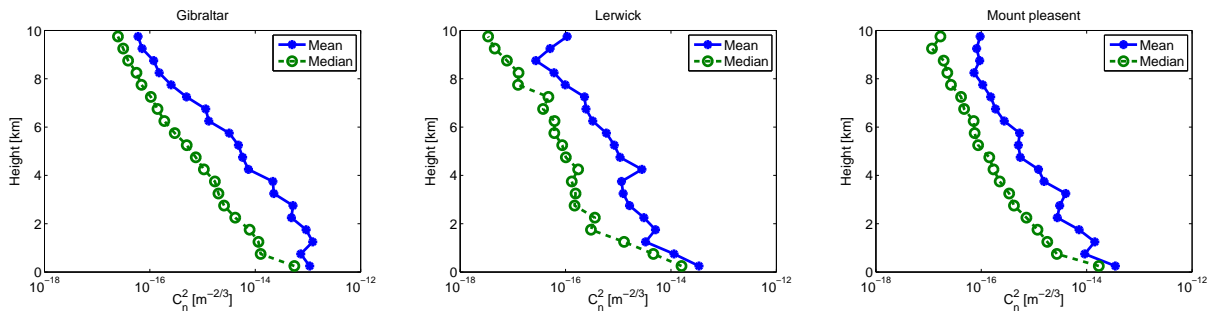

Figure 4. Mean and median profiles of the turbulence parameter  $C_n^2$  for three sample radiosonde launch sites for the year 2005.

## 6. Ocean Tide Loading

The automatic ocean tide loading provider [7] was maintained during 2008 and extended by new ocean tide models. Now it is possible to use also the ocean models GOT4.7 [8], Andersen 2006 [9] and EOT08a [10].

## 7. Outlook

The IVS Analysis Center at the Onsala Space Observatory will continue its efforts to work on specific topics relevant to space geodesy and geosciences. For 2009 we plan to intensify the analysis of VLBI data and re-start our contribution to the IVS-TROP project.

## References

- [1] Lösler, M.: Bestimmung des lokalen Verbindungsvektors zwischen IVS- und IGS-Referenzrahmen am Raumobservatorium Onsala (Schweden). *Allgemeine Vermessungs-Nachrichten*, in press, 2009.
- [2] Lösler, M.: Reference point determination with a new mathematical model at the 20 m VLBI radio telescope in Wettzell, *Journal of Applied Geodesy*, **2(4)**, 233-238, DOI: 10.1515/JAG.2008.026, 2008.
- [3] Haas, R., and Eschelbach, C.: The 2002 Local Tie at the Onsala Space Observatory. In: *Proc. of the IERS Workshop on site co-location*, Bernd Richter, Wolfgang Schwegmann, and Wolfgang R. Dick (Eds.), *IERS Technical Note*, No **33**, 55–63, Verlag des Bundesamts für Kartographie und Geodäsie, 2005.
- [4] Garcia Espada, S., Haas, R., Colomer Sanmartin, F.: Space Geodesy at Yebes: Station Motion from VLBI and GPS. In: *Proc. 5th IVS General Meeting “Measuring the future”*, A. Finkelstein and D. Behrend (Eds.), 93–97, 2008.
- [5] Nilsson, T., and Haas, R.: Modeling Tropospheric Delays with Atmospheric Turbulence Models. In: *Proc. 5th IVS General Meeting “Measuring the future”*, A. Finkelstein and D. Behrend (Eds.), 361–370, 2008.
- [6] Behrend, D., Böhm, J., Charlot, P., Clark, T., Corey, B., Gipson, J., Haas, R., Koyama, Y., MacMillan, D., Malkin, Z., Niell, A., Nilsson, T., Petrachenko, B., Rogers, A.E.E., Tuccari, G., Wresnik, J.: Recent Progress in the VLBI2010 Development. In: *Proc. 2007 IAG General Assembly*, edited by M. Sideris, Springer Verlag **133(5)**, 833–840, 2008.
- [7] Scherneck, H.-G., and Bos, M.: Ocean Tide and Atmospheric Loading. In: N. R. Vandenberg and K. D. Baver (Eds.): *IVS 2002 General Meeting Proceedings*, 205–214, NASA/CP-2002-210002, 2002.
- [8] Ray, R.: GOT4.7, pers. comm., 2008.
- [9] Andersen, O. B.: <http://www.spacecenter.dk/data/global-ocean-tide-model-1/>, 2006.
- [10] Savcenko, R., and Bosch, W.: EOT08a, empirical ocean tide model from multi-mission satellite altimetry. Deutsches Geodätisches Forschungsinstitut (DGFI), Report No. **81**, München, 2008.

# Pulkovo IVS Analysis Center (PUL) 2008 Report

*Zinovy Malkin, Natalia Miller, Julia Sokolova, Elena Popova*

## Abstract

This report briefly presents the PUL IVS Analysis Center activities during 2008 and plans for the coming year. The main topics of investigations in that period were comparison and combination of catalogs of radio source positions, analysis of VLBI EOP series, analysis of radio source position and zenith troposphere delay time series.

## 1. General Information

The PUL IVS Analysis Center was organized in September 2006 and is located at the Central Astronomical Observatory at Pulkovo of Russian Academy of Sciences (Pulkovo Observatory). The main topics of our activity are:

- Improvement of the International Celestial Reference Frame (ICRF), including investigations of stochastic and systematic errors of radio source catalogs, constructing combined catalogs, investigation of the ICRF stability, and investigation of radio source position time series.
- Computation and analysis of EOP, station position, baseline length, and zenith troposphere delay time series.
- Investigation of the Free Core Nutation (FCN).
- Comparison of VLBI results with other space geodesy techniques.

The PUL AC's Web page [http://www.gao.spb.ru/english/as/ac\\_vlbi/](http://www.gao.spb.ru/english/as/ac_vlbi/) is supported.

## 2. Scientific Staff

The PUL team consists of three scientists:

1. Zinovy Malkin (70%) — team coordinator, EOP, TRF, and CRF computation and analysis;
2. Natalia Miller (10%) — EOP and zenith troposphere delay analysis;
3. Julia Sokolova (100%), until September, now on leave of absence at the Curtin University of Technology, Australia — CRF computation and analysis;
4. Elena Popova (50%), since August — radio source velocities analysis.

## 3. Activities

The main activities of the PUL IVS Analysis Center during 2008 included:

- Investigations in the framework of the IERS/IVS Working Group on the Second Realization of the ICRF were continued. The main directions of this activity were comparison and combination of radio source catalogs as well as computation and investigation of source position time series. The main results obtained in 2008 are the following:

- A new combined radio source catalog was constructed and investigated [1].
  - A new method of assessment of the time series scatter based on an extension of the Allan deviation technique, which allows the treatment of unequally weighted and multi-dimensional data [2], was applied to the analysis of the source position time series. This method allows us to get a new estimate of the radio source stability independent of systematic and low-frequency source position variations.
  - The impact of the radio source selection strategy and source position instability on CRF and celestial pole offset estimates was further investigated. Analysis showed that variations of radio source coordinates affect celestial pole offset estimates [3].
  - Various other issues related to the construction of ICRF-2 were investigated [4].
  - The first version of a new list of the optical characteristics of geodetic radio sources is compiled. Further development is being performed in cooperation with the AUS Analysis Center and Pulkovo optical astronomers [5].
- Influence of low-elevation observation weighting on estimates of EOP and baseline length was investigated for a case of CONT05 campaign [6].
  - A comparison of EOP results obtained from various VLBI networks and observing programs based on the VLBI network volume as a new network geometry index was performed. Accounting for a network volume allows investigation of finer dependencies such as dependence of the EOP errors on recording data rate [7].
  - Several longest and densest zenith troposphere delay time series provided by the IGG IVS Special Analysis Center as an IVS troposphere product were analyzed by means of the method of Singular Spectrum Analysis (SSA) in both one-dimensional and multi-dimensional modes. The structure of the time series including regular, quasi-regular (periodical), and irregular (trend) components was obtained and investigated. Using SSA allowed us to derive nonlinear trends in zenith troposphere delay, and also research the variation of amplitude and phase of season components with time [8].
  - An analysis of the systematic effects in the observed radio source velocities was started [9].
  - A list of the forthcoming close approaches of Jupiter and Saturn to geodetic radio sources through the year 2050 was computed [10].
  - A regular computation of two refined Free Core Nutation (FCN) time series started in 2006 was continued. These series are available at the PUL Web page.
  - Development of algorithms and software for data processing and analysis was continued.
  - PUL archive of VLBI data and products was originated at the end of 2006. At present, all available databases and NGS cards have been stored along with main IVS and IERS products.
  - PUL staff members participated in activities of several IVS projects, Working Groups, and Committees.

## 4. Outlook

Plans for the coming year include:

- Continuation of the IVS related studies.
- Development of the algorithms and software used for data processing.
- Support of the PUL archive of data and products.

## References

- [1] Sokolova Ju., Malkin Z. Comparison and Combination of CRF Catalogues. In: *Measuring the Future, Proc. Fifth IVS General Meeting*, A. Finkelstein, D. Behrend (Eds.), 2008, 275–278.
- [2] Malkin Z. On accuracy assessment of celestial reference frame realizations. *Journal of Geodesy*, 2008, v. 82, No. 6, 325–329.
- [3] Sokolova Ju. Effect of the reference radio source selection on VLBI CRF realization. Presented at the X Finish-Russian Symposium on Radio Astronomy, Orilampi, Finland, 1–5 Sep 2008.
- [4] Malkin Z. On Construction of ICRF-2. In: *Measuring the Future, Proc. Fifth IVS General Meeting*, A. Finkelstein, D. Behrend (Eds.), 2008, 256–260.
- [5] Malkin Z., Titov O. Optical Characteristics of Astrometric Radio Sources. In: *Measuring the Future, Proc. Fifth IVS General Meeting*, A. Finkelstein, D. Behrend (Eds.), 2008, 183–187.
- [6] Malkin Z. Influence of Elevation-Dependent Weighting on Parameter Estimates: A Case of CONT05. In: *Measuring the Future, Proc. Fifth IVS General Meeting*, A. Finkelstein, D. Behrend (Eds.), 2008, 178–182.
- [7] Malkin Z. On comparison of the Earth orientation parameters obtained from different VLBI networks and observing programs. *Journal of Geodesy*, 2008, DOI: 10.1007/s00190-008-0265-2.
- [8] Miller N., Malkin Z. Using the Singular Spectrum Analysis for Investigation of Troposphere Parameters. In: *Measuring the Future, Proc. Fifth IVS General Meeting*, A. Finkelstein, D. Behrend (Eds.), 2008, 302–306.
- [9] Malkin Z., Popova E. Analysis of source motions derived from position time series. Presented at Journées 2008 and Xth Lohrmann-Kolloquium: Astrometry, Geodynamics and Astronomical Reference Systems, Dresden, Germany, 22–24 Sep 2008.
- [10] L'vov V.N., Malkin Z.M., Tsekmejster S.D. Forthcoming close approaches of Jupiter and Saturn to geodetic radio sources. Presented at Journées 2008 and Xth Lohrmann-Kolloquium: Astrometry, Geodynamics and Astronomical Reference Systems, Dresden, Germany, 22–24 Sep 2008.

# SHAO Analysis Center 2008 Annual Report

*Jinling Li*

## Abstract

Our research activities in 2008 are related to astrometric and geodetic VLBI experiments and data analysis, the astrometry of massive star-forming regions and luminous red supergiants, the processing of VLBI tracking data of satellites, and antenna site surveys. These activities will be continued in the next year. We will prepare software for the next Chinese lunar and Martian exploration projects.

## 1. General Information

We use the CALC/SOLVE system for routine VLBI data analysis. We are developing software coded in FORTRAN to deal with satellite tracking data using the VLBI, ranging and Doppler techniques. The members involved in the IVS analysis activities are Guangli Wang, Bo Zhang, Shubo Qiao, Zhihan Qian, and Jinling Li.

## 2. Activities in 2008

We participated in some IERS/IVS campaigns aimed at comparisons of reference frames and/or Earth Rotation Parameters. Our research activities in 2008 are also related to the VLBI experiments and data analysis from the Chinese VLBI Network (CVN), the astrometry of massive star-forming regions and luminous red supergiants, the processing of VLBI tracking data of satellites, and antenna site surveys.

### 2.1. Astrometric and Geodetic VLBI Experiments and Data Analysis

For the compilation of the next generation of ICRF, we submitted to IVS an extragalactic radio source catalogue and a source coordinate time series from our solutions. We conducted VLBI experiments using the CVN, including the antennas at Shanghai, Urumqi, Beijing, and Kunming, and performed the related data analysis in order to determine the coordinates and velocities for the Chinese space exploration projects, as well as for the Project of Monitoring Network of the Chinese Mainland Geological Environment. Using the Calc/Solve system, we obtained a series of global solutions of astrometric and geodetic VLBI observations by changing the settings of the control parameters. By comparison and statistical analysis of the solutions, we proposed a list of candidate stable sources.

### 2.2. Astrometry of Massive Star-forming Regions and Luminous Red Supergiants

We have measured trigonometric parallaxes of methanol masers in the high-mass star-forming regions G35.20–0.74 and G35.20–1.74, corresponding to distances of  $2.19^{+0.24}_{-0.20}$  kpc and  $3.27^{+0.56}_{-0.42}$  kpc, respectively. The distances to both sources are close to their near kinematic distances and place them in the Carina-Sagittarius spiral arm. Combining the distances and proper motions with observed radial velocities gives the locations and full space motions of the star-forming regions. Assuming a standard model of the Galaxy, G35.20–0.74 and G35.20–1.74 have peculiar motions



of  $\sim 13 \text{ km s}^{-1}$  and  $\sim 16 \text{ km s}^{-1}$  counter to Galactic rotation and  $\sim 9 \text{ km s}^{-1}$  toward the North Galactic Pole.

Accurate distances to the hyper-luminous red supergiants (VY CMa, NML Cyg, VX Sgr, AH Sco, and S Per) are very important to understanding the characteristics of this category of sources, such as stellar radius, mass, luminosity, and circumstellar mass loss. We have proposed to measure trigonometric parallaxes and proper motions of the H<sub>2</sub>O and SiO masers in the Luminous Red Supergiants NML Cyg and AH Sco, to try to achieve distances accurate to better than 5%. Our observations would reference both maser species to the same quasar. This would allow us to measure the H<sub>2</sub>O and the SiO masers with milli-arcsec accuracy. A future VLA A-configuration observation would determine the size of the radio photosphere and reference the star to the masers. The combined VLBA/VLA results will allow a direct measurement of acceleration around the dust formation zone (between the SiO and H<sub>2</sub>O maser radii) and hence lead to a better understanding of dust formation. In addition, since supergiants have not lived long enough to wander far from their birth sites in high mass star-forming regions, the parallax observations will add more sources to help map the Milky Way's spiral structure. Observations of the Red Supergiants NML Cyg with the VLBA (7 hours  $\times$  5 epochs, 2008–2009) and AH Sco with VERA (6 hours  $\times$  4 epochs + 5 hours  $\times$  10 epochs, 2008–2009) are on-going. The first three epochs have been analyzed, and the data look excellent.

### 2.3. Data Analysis in the Chinese Space Exploration Projects

In the Chinese lunar exploration project Chang'E-1 (CE-1), the satellite tracking data consist of range and Doppler measurements as well as the VLBI delay and delay rate. We have developed reduction software to provide the estimation of instantaneous state vectors of the satellite, and we have processed the tracking data of the CE-1 satellite in real-time. A geometric reduction is performed in lieu of an application of dynamic constraints to the observations belonging to different wave-fronts at different epochs, and so the length of tracking arc is not a crucial prerequisite. The software could be used to monitor the quality of tracking data and to identify the evolution of satellite orbits, with the efficiency and speed needed to implement projects.

The next step is to perform the synthesis reduction of VLBI observations of satellites and quasars, especially differential VLBI observations and same beam interferometry observations, which are especially important for the next Chinese lunar and Martian explorations.

### 2.4. Site Survey at the Sheshan 25-m Radio Telescope

We conducted a site survey at the Sheshan 25-m radio telescope in July and August 2008 in order to develop a strategy of observing and data analysis, to develop software and to check the precision of parameter solutions. This survey is a part of the whole effort to determine the local tie parameters among the sites of VLBI and SLR at Sheshan. Such parameters are important to the compilation of terrestrial reference frames based on various space geodetic techniques.

In a distinct difference from the previous surveys at this telescope, in this survey the local control network was set up as reinforced concrete pillars with stainless steel devices on top for forced centering. With this set up, the long term stability of the control points and the high precision of the height measurement of the instruments and targets could be sustained in comparison to temporary ground marks and survey tripods.

During observing, the network was arranged around the antenna to provide the best possible

geometry given the restriction that the antenna is not centrally located in the observing yard. Also, redundant data were collected in order to sustain the precision of parameter solutions. Especially some improvements to the fitting of arcs and lines in space, were proposed and adopted: specifically, using the transformation of coordinate systems to simplify a 3-dimensional fitting to a planar reduction, which sustains the stability and uniqueness of parameter solutions. For instance, the projection method is usually used to fit to a circle in space—that is, to fit an ellipse projected from a circle in space onto a plane. Results from data simulation show that in the projection method, the solution of parameters is quite unstable and becomes dispersive even with a relatively low level of observation noise. But in the method of coordinate system transformation, the normal direction of the plane inscribed by a circle in space is firstly determined. This direction is taken as the z-axis of a temporary coordinate system, in which the circle becomes planar and could be easily fitted with only three parameters, including two for the planar coordinates of the center and one for the radius. The solution is proved to be quite stable, and the observation noises are well suppressed. Comparatively, in the fitting of a planar ellipse there should be five parameters including two for the center coordinates, two for the semi-major and minor axes and one for the direction of the semi-major axis.

In the WGS84 (G1150) system, the coordinates of the reference mark of the Sheshan 25-m radio telescope are determined from this survey as:

$$-2831687.3377 \text{ m} \pm 0.84 \text{ mm}$$

$$4675734.2901 \text{ m} \pm 0.99 \text{ mm}$$

$$3275329.0112 \text{ m} \pm 0.88 \text{ mm}$$

The reference epoch is MJD54689, and the axis offset is fit to be  $3.4 \pm 0.7 \text{ mm}$ . The precision is at the millimeter level, which shows the rationality and validity of the strategy and the implementation of the steps in this survey.

### 3. Plans for 2009

The above mentioned research activities will be continued in 2009. Specifically, we will accumulate knowledge and develop software for the next Chinese space exploration projects.

## U.S. Naval Observatory VLBI Analysis Center

*David A. Boboltz, Alan L. Fey, Jennifer L. Bartlett, Zachary Dugan, Kerry A. Kingham,  
David M. Hall*

### Abstract

This report summarizes the activities of the VLBI Analysis Center at the United States Naval Observatory for calendar year 2008. Over the course of the year, Analysis Center personnel analyzed biweekly 24-hour experiments with designations IVS-R1 and IVS-R4 for use in-house and continued timely submission of IVS-R4 databases for distribution to the IVS. During the 2008 calendar year, the USNO Analysis Center produced two periodic global Terrestrial Reference Frame (TRF) solutions with designations usn2008a and usn2008b. Earth orientation parameters (EOP) based on these solutions, updated by the latest 24-hour (IVS-R1 and IVS-R4) experiments, were submitted to the IVS.

Other activities in the 2008 calendar year included the continued submission of Sinex files based on new 24-hour experiments to the IVS. For the Celestial Reference Frame (CRF), Analysis Center personnel continued a program designed to increase the sky density of ICRF sources, especially in the Southern Hemisphere. Activities included scheduling, analyzing and submitting databases for IVS-CRF experiments, and the production of global CRF solutions designated crf2008a and crf2008b. In addition, Analysis Center personnel performed research into the next generation ICRF-2 and a future high-frequency reference frame based on the VLBA K/Q-band experiments. Activities planned for the 2009 calendar year include the continued production of EOP/TRF/CRF global solutions and continued research into future reference frames.

## 1. Introduction

The USNO VLBI Analysis Center is supported and operated by the United States Naval Observatory (USNO) in Washington, DC. The primary services provided by the Analysis Center are the analysis of 24-hour experiments, the production of periodic global Terrestrial Reference Frame (TRF) and Celestial Reference Frame (CRF) solutions, and the submission to the IVS of intensive (EOP-I) and session-based (EOP-S) Earth orientation parameters based on USNO global TRF solutions. Analysis Center personnel maintain the necessary software required to continue these services to the IVS including periodic updates of the GSFC CALC/SOLVE software package. In addition to operational VLBI analysis, USNO personnel engage in research aimed at developing the next generation ICRF. Information on USNO VLBI analysis activities may be obtained at:

<http://www.usno.navy.mil/USNO/astrometry/vlbi-products/>.

## 2. Current Analysis Center Activities

### 2.1. Experiment Analysis and Database Submission

During the 2008 calendar year, personnel at the USNO VLBI Analysis Center continued processing 24-hour (IVS-R1 and IVS-R4) experiments for use in internal USNO global TRF and CRF solutions. USNO is also responsible for the timely analysis of the IVS-R4, and the resulting databases are submitted within 24 hours of correlation for dissemination by the IVS. In addition, Analysis Center personnel continue to be responsible for the analysis and database submission for the periodic IVS-CRF experiments. The primary goal of these experiments is the densification of ICRF sources in the Southern Hemisphere. In 2008, USNO scheduled and analyzed 18 CRF related experiments including IVS-CRF49 through IVS-CRF54, IVS-CRDS42 through IVS-CRDS49, and

IVS-CRMS04 through IVS-CRMS06. The analyzed databases were submitted to the IVS. In the 2008 calendar year, Analysis Center personnel also continued analyzing IVS intensive experiments for use in a USNO EOP-I time series.

## 2.2. Global TRF Solutions, EOP and Sinex Submission

USNO VLBI Analysis Center personnel continued to produce periodic global EOP/TRF solutions (usn2008a and usn2008b) over the course of the 2008 calendar year. Information, images, and data files regarding the most recent USNO global EOP/TRF solutions may be found at:

<http://www.usno.navy.mil/USNO/astrometry/vlbi-products/reference-frames/>.

An example of the information available on the Web site is shown in Figure 1. It shows the distribution of the RMS delays and rates for the 3763 24-hour experiments in the latest USNO solution, usn2008b. Session-based Earth orientation parameters derived from our solutions are routinely compared to those derived from GSFC periodic TRF solutions and with the IERS-C05 time series prior to submission to the IVS.

Analysis Center personnel continued to produce an EOP-S series based on the global TRF solutions and continuously updated by new data from the IVS-R1/R4 experiments. This updated EOP-S series is submitted to the IVS twice weekly within 24 hours of experiment correlation and is included in the IERS Bulletin A. Analysis Center personnel continued to submit Sinex format

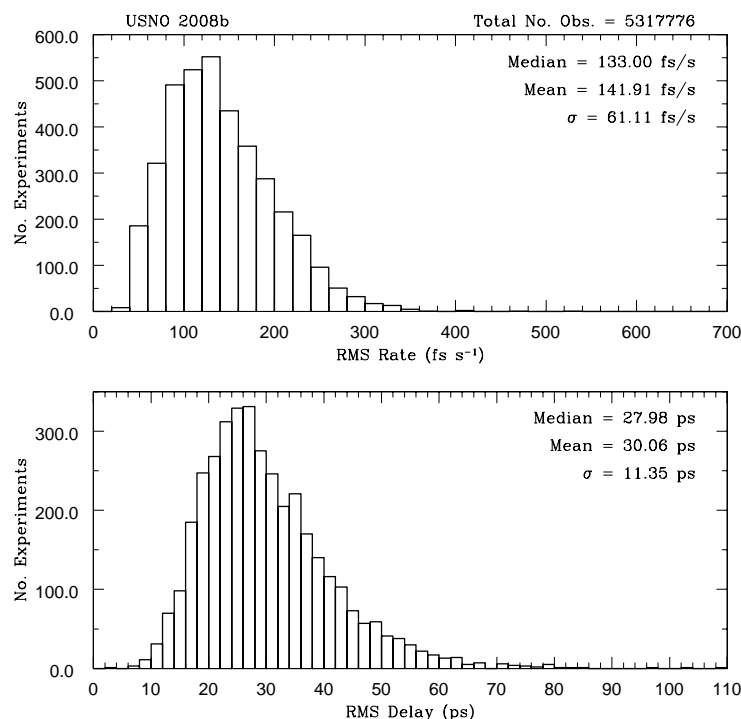

Figure 1. Distribution of RMS delay and rate for the 3763 24-hour sessions in the latest USNO global TRF/EOP solution usn2008b.

files based on the 24-hour VLBI sessions.

In addition to EOP-S and Sinex series, USNO Analysis Center personnel continued to produce and submit to the IVS an EOP-I series based on the IVS intensive experiments.

### 2.3. Celestial Reference Frame

During the 2008 calendar year, Analysis Center personnel continued work on the production of global CRF solutions for dissemination by the IVS including crf2008a and crf2008b. These solutions are routinely compared to the current ICRF and are available through the previously mentioned Web site: <http://www.usno.navy.mil/USNO/astrometry/vlbi-products/reference-frames/>.

During 2008, Analysis Center personnel performed a variety of CRF related research activities with the purpose of improving the present ICRF and preparing for future VLBI-based reference frames. Efforts were focused on two primary areas: the completion of two papers summarizing the astrometry and imaging work performed for the K/Q-band program, and research performed in preparation for ICRF-2. In conjunction with collaborators from Bordeaux Observatory, NASA-GSFC, NASA-HQ, NASA-JPL, and NRAO, Analysis Center personnel finalized results from the K/Q-program, and two journal articles were submitted (Lanyi et al. 2009, AJ, submitted; and Charlot et al. 2009, AJ, submitted). In preparation for ICRF-2, Analysis Center personnel produced numerous CRF solutions, performed time series analysis of source position variations for the purpose of source classification, and investigated the feasibility of adding the VLBA Calibrator Survey sources to the CRF.

Figure 2 shows the distributions for the maximum source structure index as determined from observations taken through the K/Q-band high-frequency reference frame program. The figure shows the results for all sources observed over three observing bands X, K, and Q. Results show an improvement in mean source structure index with increased observing frequency over the three bands observed (Charlot et al. 2009, AJ, submitted).

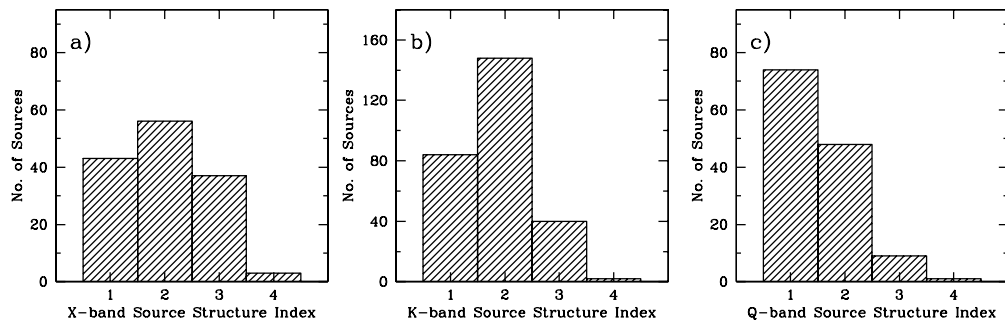

Figure 2. Distributions of values for the maximum source structure index ( $SI$ ) at a) X band, b) K band and c) Q band. There were a total of 138, 274, and 132 sources, respectively, for which the flux density was measured at each of the three bands in our VLBA data set.

### 3. Staff

The staff of the VLBI Analysis Center is drawn from individuals in both the Astrometry and Earth Orientation departments at the U.S. Naval Observatory. The staff and their responsibilities are as follows:

Table 1. Staff.

Name	Responsibilities
David Boboltz	Periodic global TRF solutions and comparisons, Sinex generation and submission, Web page administration, VLBI data analysis.
Alan Fey	Periodic global CRF solutions and comparisons, CRF densification research, Web page administration, VLBI data analysis.
Jennifer Bartlett	VLBI data analysis, EOP and database submission.
Zachary Dugan	VLBI data analysis, EOP and database submission.
Kerry Kingham	Correlator interface, VLBI data analysis.
David Hall	Correlator interface, VLBI data analysis.

### 4. Future Activities

For the upcoming year January 2009–December 2009, USNO VLBI Analysis Center personnel plan to accomplish the following activities:

- Continue the processing of biweekly IVS-R1/R4 experiments for use in internal TRF and CRF global solutions and continue submission of IVS-R4 databases for dissemination by the IVS.
- Continue the production of periodic global TRF solutions and the submission of EOP-S estimates to the IVS updated by the IVS-R1/R4 experiments.
- Continue submission of Sinex format files based on the 24-hour experiments and begin production of a Sinex series based upon the intensive experiments.
- Continue the analysis of intensive experiments and submission of EOP-I estimates to the IVS.
- Continue the scheduling, analysis and database submission for all IVS-CRF experiments.
- Continue the production of periodic global CRF solutions.
- Continue research into source characterization and the development of the second realization of the ICRF (ICRF-2).
- Continue research into the development of high-frequency reference frames based upon VLBA K- and Q-band sessions.

# USNO Analysis Center for Source Structure Report

*Alan L. Fey, David A. Boboltz, Roopesh Ojha, Ralph A. Gaume, Kerry A. Kingham*

## Abstract

This report summarizes the activities of the United States Naval Observatory Analysis Center for Source Structure for calendar year 2008. VLBA RDV experiments RDV67 and RDV69 were calibrated and imaged. Images from these two experiments, together with images from RDV14, RDV17, RDV19, and RDV22, were added to the USNO Radio Reference Frame Image Database. A Southern Hemisphere imaging and astrometry program for maintenance of the ICRF continued. Activities planned for the year 2009 include continued imaging of ICRF sources at standard and higher frequencies and continued analysis of source structure and its variation.

## 1. Analysis Center Operation

The Analysis Center for Source Structure is supported and operated by the United States Naval Observatory (USNO). The charter of the Analysis Center is to provide products directly related to the IVS determination of the “definition and maintenance of the celestial reference frame.” These include, primarily, radio frequency images of ICRF sources, intrinsic structure models derived from the radio images, and an assessment of the astrometric quality of the ICRF sources based on their intrinsic structure.

The Web server for the Analysis Center is hosted by the USNO and can be accessed by pointing your browser to

[http://rorf.usno.navy.mil/ivs\\_saac/](http://rorf.usno.navy.mil/ivs_saac/)

The primary service of the Analysis Center is the Radio Reference Frame Image Database (RRFID), a Web accessible database of radio frequency images of ICRF sources. The RRFID contains 6,231 Very Long Baseline Array (VLBA) images (a 25% increase over the previous year) of 685 sources (an 8% increase over the previous year) at radio frequencies of 2.3 GHz and 8.4 GHz. Additionally, the RRFID contains 1339 images (a zero percent increase over the previous year) of 274 sources (a 1% increase over the previous year) at frequencies of 24 GHz and 43 GHz. The RRFID can be accessed from the Analysis Center Web page or directly at

<http://www.usno.navy.mil/rrfid/>

The RRFID also contains 74 Australian Long Baseline Array (LBA) images of 69 Southern Hemisphere ICRF sources at a radio frequency of 8.4 GHz.

Shown in Figure 1 is the distribution on the sky of the sources which have been imaged at 24 GHz.

## 2. Current Activities

### 2.1. VLBA Imaging

VLBA experiment RDV69 (2008MAY14) was calibrated and imaged, adding 201 (100 S-band; 101 X-band) images to the RRFID including images of 19 sources (0131-450, 0316-444, 0437-454, 0632-183, 0648-287, 0733-187, 1223-188, 1333-152, 1418-192, 1600+294, 1639-200, 1718-259, 1845-273, 1925-206, 2000-330, 2149-306, 2056-369, 2314-409, and 2329-415) not previously imaged.

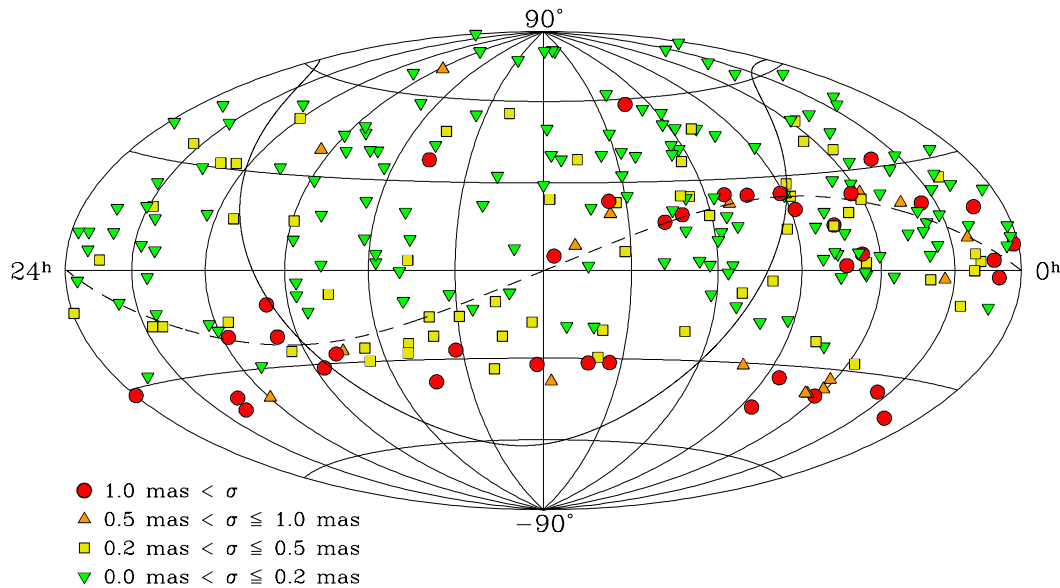

Figure 1. Distribution of the sources which have been imaged at 24 GHz shown on an Aitoff equal area projection of the celestial sphere. The different symbols represent the approximate positional uncertainty from a recent global astrometric solution (see § 2.2) as indicated by the key.

VLBA experiment RDV67 (2008JAN23) was calibrated and imaged, adding 194 (97 S-band; 97 X-band) images to the RRFID including images of 17 sources (0131-367, 0244-452, 0451-282, 0558-396, 0625-354, 1038+52A, 1251-197, 1333-337, 1404-342, 1531-352, 1645-329, 1705-353, 1710-323, 1749+096, 1751+441, 1926+087 and 2106-413) not previously imaged.

VLBA experiment RDV22 (2000JUL06) was calibrated and imaged, adding 179 (89 S-band; 90 X-band) images to the RRFID including images of 3 sources (822-173, 1829-106, and 2211-388) not previously imaged. These results were contributed by Glenn Piner and Corey Nichols of Whittier College who calibrated, edited, and imaged the data.

VLBA experiment RDV19 (2000JAN31) was calibrated and imaged, adding 171 (85 S-band; 86 X-band) images to the RRFID including images of 3 sources (0426-380, 0430+289, and 2054-377) not previously imaged. These results were contributed by Glenn Piner and Corey Nichols of Whittier College who calibrated, edited, and imaged the data.

VLBA experiment RDV17 (1999AUG02) was calibrated and imaged, adding 159 (77 S-band; 82 X-band) images to the RRFID including images of 2 sources (0651+410 and 1125+596) not previously imaged. These results were contributed by Glenn Piner and Corey Nichols of Whittier College who calibrated, edited, and imaged the data.

VLBA experiment RDV14 (1999APR15) was calibrated and imaged, adding 180 (90 S-band; 90 X-band) images to the RRFID including images of 2 sources (0844+258 and 1239+606) not previously imaged. These results were contributed by Glenn Piner and Corey Nichols of Whittier



College who calibrated, edited, and imaged the data.

Collaborations continue with Glenn Piner at Whittier College and Patrick Charlot of Bordeaux University to calibrate and image several of the VLBA RDV experiments.

## 2.2. VLBA High Frequency Imaging

VLBA observations to extend the ICRF to 24 and 43 GHz continued in 2008. These observations are part of a joint program between the National Aeronautics and Space Administration, the USNO, the National Radio Astronomy Observatory (NRAO), and Bordeaux Observatory. During the calendar year 2008 two papers were submitted for publication in the refereed literature: 1) “The Celestial Reference Frame at Higher Radio Frequencies. I. Astrometry from VLBA Observations at 24 and 43 GHz” by Lanyi et al. and 2) “The Celestial Reference Frame at Higher Radio Frequencies. II. VLBA Imaging at 24 and 43 GHz” by Charlot et al. Shown in Figure 1 is the distribution on the sky of the sources for which accurate astrometric positions have been determined at 24 GHz.

## 2.3. ICRF Maintenance in the Southern Hemisphere

The USNO and the Australia Telescope National Facility (ATNF) continue a collaborative program of VLBI research on Southern Hemisphere source imaging and astrometry using USNO, ATNF, and ATNF-accessible facilities. These observations are aimed specifically toward improvement of the ICRF in the Southern Hemisphere. One celestial reference frame experiment, CRF-S12, was scheduled with antennas at Hobart, Australia; Hartebeesthoek, South Africa, and the 70-meter Deep Space Network antenna at Tidbinbilla, Australia.

A program to monitor the structure of quasars south of declination  $-30^\circ$  that are either known to be gamma-ray loud or are expected to be gamma-ray loud continued. The program, called TANAMI (Tracking Active galactic Nuclei with Australia Milliarcsecond Interferometry), is observing a sample of about 40 quasars at 8 GHz and 24 GHz bands, with half of the sample observed every two months.

## 3. Staff

The staff of the Analysis Center is drawn from individuals who work at the USNO. The staff are: Alan L. Fey, David A. Boboltz, Roopesh Ojha, Ralph A. Gaume, and Kerry A. Kingham.

## 4. Future Activities

The Analysis Center currently has a program of active research investigating the effects of intrinsic source structure on astrometric position determination. Results of this program are published in the scientific literature.

The following activities for 2009 are planned:

- Continue imaging and analysis of VLBA 2.3/8.4/24/43 GHz experiments
- Make additional astrometric and imaging observations in the Southern Hemisphere in collaboration with ATNF partners





**Technology Development Centers**

**Technology Development Centers**



# Canadian VLBI Technology Development Center

*Bill Petrachenko*

## Abstract

The Canadian VLBI Technology Development Center (TDC) is actively involved in theoretical studies to define recommendations for the VLBI2010 system. In addition, two development programs at the Dominion Radio Astrophysical Observatory (DRAO) are of potential interest to VLBI2010. Composite antennas that are light, stiff, and cost effective are being developed, and a state-of-the-art correlator is being developed for the EVLA.

## 1. Introduction

The Canadian TDC is a collaborative effort of the National partners interested in the advancement of VLBI technology, namely the Geodetic Survey Division of Natural Resources Canada (GSD/NRCan) and the Dominion Radio Astrophysical Observatory (DRAO) of the Herzberg Institute for Astrophysics of the National Research Council of Canada, (DRAO/HIA/NRC).

## 2. VLBI2010 Committee

Activity within the Canadian TDC is now focussed primarily on supporting recommendations for IVS' VLBI2010. This is being done through Bill Petrachenko's participation as chairman of the V2C. In the past year, activity has mainly focused on consolidating the current conception of the project through the production of a VLBI2010 Progress Report. The report is about to be released. Detailed definition of VLBI2010 sub-systems is the major focus for the future.

## 3. DRAO Activities

DRAO has a long history of participation in VLBI beginning with the first ever successful fringes in 1967. Expertise exists in a number of relevant disciplines from innovative antenna/feed/receiver design to the design and implementation of large complex digital systems.

Of particular interest to VLBI2010 are the composite antennas being designed for radio astronomy. These are 10 m diameter antennas based on composite materials that are light, stiff, and cost effective. Under the leadership of Dean Chalmers and Gordon Lacy, a second prototype antenna (10 m) was produced in the summer of 2008 with significantly improved surface accuracy.

In addition to the antenna development effort, DRAO, under the leadership of Brent Carlson and Dave Fort, is producing the correlator for the EVLA project. It is one of the most ambitious radio interferometry correlators ever designed, handling, in real time, 32 stations at a maximum data rate of 96 Gbps per antenna. Although primarily intended for connected element interferometry, it is also designed to be VLBI-capable. In the past year, the first fringes were detected with a scaled down version of the correlator, with expansion to the full EVLA configuration about to begin.



Figure 1. Second prototype 10 m composite antenna at DRAO being used to test focal plane array.

# FFI Technology Development Center - Software Development

*Per Helge Andersen*

## Abstract

FFI's contribution to the IVS as a Technology Development Center focuses primarily on the development and validation of the GEOSAT software for a combined analysis at the observation level of data from VLBI, GPS and SLR. This report shortly summarises the latest improvements of the GEOSAT software. FFI is currently an Analysis Center for IVS and ILRS, and a Technology Development Center for IVS.

## 1. The GEOSAT Software

FFI's contribution to the IVS as a Technology Development Center focuses primarily on the development and validation of the GEOSAT software for a combined analysis at the observation level of data from VLBI, GPS and SLR. The advantages of the combination of independent and complementary space geodetic data at the observation level is discussed in Andersen ([1]). After five years of development and extensive validation we are proud to announce that a major revision and extension of the GEOSAT software has been completed. The most important changes implemented have been described in recent IVS Annual Reports. New in 2008 is ambiguity resolution of undifferenced GPS data. Only resolved data are used in the analysis, which has reduced the number of GPS stations in the solution for each arc from approximately 175 to 135. The actual stations involved in an arc change in general from day to day. Another extension is that the rates of the Earth orientation parameters are estimated. In 2008 the focus has been on the application of GEOSAT to real data. The status of this work is described in the FFI Analysis Center report.

We hope to include space-borne gravity (accelerometer, gradiometer, sat-sat range/doppler, altimetry etc.) in GEOSAT for a simultaneous analysis using VLBI, SLR and GPS. This extension will be made possible by a close collaboration between Statens Kartverk and FFI.

## 2. Staff

Dr. Per Helge Andersen - Research Professor of Forsvarets forskningsinstitutt (FFI) and Institute of Theoretical Astrophysics, University of Oslo.

## References

- [1] Andersen, P. H. Multi-level arc combination with stochastic parameters. *Journal of Geodesy* (2000) 74: 531-551.

# GSFC Technology Development Center Report

*Ed Himwich, John Gipson*

## Abstract

This report summarizes the activities of the GSFC Technology Development Center (TDC) for 2008 and forecasts planned activities for 2009. The GSFC TDC develops station software including the Field System, scheduling software (SKED), hardware including tools for station timing and meteorology, scheduling algorithms, and operational procedures. It provides a pool of individuals to assist with station implementation, check-out, upgrades, and training.

## 1. Technology Center Activities

The GSFC IVS Technology Development Center (TDC) develops hardware, software, algorithms, and operational procedures. It provides manpower for station visits for training and upgrades. Other technology development areas at GSFC are covered by other IVS components such as the GSFC Analysis Center. The current staff of the GSFC TDC consists of John Gipson and Ed Himwich, both employed by NVI, Inc. The remainder of this report covers the status of the main areas of development that are currently being pursued.

## 2. Field System

The GSFC TDC is responsible for development, maintenance, and documentation of the Field System (FS) software package. The FS provides equipment control at VLBI stations. It interprets the .snp schedule and .prc procedure files (both as prepared by DRUDG from the .skd schedule). The FS controls the antenna, data acquisition hardware, and related ancillary equipment needed for making VLBI measurements. All major VLBI data acquisition backends are supported. The FS is customizable to allow it to control station specific equipment. It is used at all the IVS network stations (over 30) and also at many stations that do VLBI only for astronomical observations. The only major VLBI facilities not using it are the VLBA and VERA.

During this period some of the new features that were released in FS version 9.10 were:

- A `-No_X` option was added to the `fs` program to allow it to be started from a non-X-server terminal. The `oprin` program can be run in a separate terminal window and has a new `end_oprin` command to allow it to be terminated gracefully. In this case, the user can examine the `logfile` using the

```
tail -f log logfile
```

command in another window.

- The `TNX` command was expanded to distinguish multiple instances of the same error mnemonic.
- The `plotlog` utility was expanded to handle PCal amplitude Tsys normalization, improved phase difference plots, K5 PCal plotting, and plot selection.
- The new `monpcal` utility for realtime PCal display was added.



- The *logpl* log plotting utility was upgraded with a new expanded version written in Python. The new version includes: XY plots, plotting of pcal output from decode4 commands, and many new plotting capabilities.
- The FS Linux 7 (FSL7) distribution (based on Debian *etch*) was developed and deployed. This effort included a complete update of the installation and upgrade documentation.
- A new version of the *gnplt* gain analysis utility was developed in Python. This version is much faster and provides more flexibility in handling the data, as well as better graphics. It will be distributed next year.
- Various upgrades were made to the source code to fix bugs and to make the code compatible with more compilers and specifically the new FSL7 distribution.

In the next year, several other improvements are expected; among these are: (1) Support for DBBC and DBE racks, (2) a complete update to the documentation and conversion to a more modern format that will be easier to use; (3) conversion of the FORTRAN source to use the *gfortran* compiler; this will enable use of the source level debugger, *gdb*, for development and field debugging; (4) use of *idl2rpc* for remote operation; (5) *chekr* support for Mark 5A and 5B systems; (6) use of the Mark IV Decoder for phase-cal extraction in the field; (7) FS Linux 8 (based on Debian *lenny*) development; (8) support for periodic firing of the noise diode during observations; and (9) distribution of the new *gnplt*.

### 3. SKED and DRUDG

The GSFC TDC is responsible for the development, maintenance, and documentation of SKED and DRUDG. These two programs are very closely related, and they operate as a pair for the preparation of the detailed observing schedule for a VLBI session and its proper execution in the field. In the normal data flow for geodetic schedules, first SKED is run at the Operation Centers to generate the .skd file that contains the full network observing schedule. Then stations use the .skd file as input to DRUDG for making the control files and procedures for their station. Catalogs are used to define the equipment, stations, sources, and observing modes which are selected when writing a schedule with SKED.

Changes to SKED and DRUDG are driven by changes in equipment and by feedback from the users. The following summarizes some of the important changes to these programs in 2008.

#### 3.1. SKED

The following changes were made to SKED.

- The installation procedure for SKED was simplified. Previously users had to modify makefiles for SKED and four associated libraries (skdrut, matrix, lnfch, and curses) so that they would point to the correct compilers and system libraries. This procedure was modified so that the paths to the compilers and libraries are now environment variables and are set via the script `set_misc`. All the user has to do is to modify this script, execute it, and then run `sked_make`, which will make all of the required SKED libraries and then compile and link SKED.
- For about 10 scans during CONT08, a station arrived late on source. A seemingly unrelated problem was that occasionally a station would be scheduled to be in two scans at the same

time. Both issues were traced to a bug in the ‘tag-along’ mode. This bug was fixed.

- Previously when the **Remove** command was used to remove stations from scans, SKED would not check how many stations were left in the scan. This could lead to a situation where only one station was observing. This bug was fixed.
- The scheduling algorithm was improved to give 10-15% more observations.
- New symbolic time names were introduced: **Start** or **Begin** will move you to the start of the schedule; **End** to the end.
- Some obsolete commands were eliminated, and some new commands were introduced.

Plans for the next year include: (1) updating documentation, (2) making VEX format native, and (3) supporting *CLEAN* components for source flux models.

### 3.2. DRUDG

DRUDG is a mature program, and there were not many changes during 2008. The following changes were made to DRUDG.

- Dymo printing was modified to give stations greater flexibility. Some options which were hard-coded can now be specified in the `skedf.ctl` file. Also, the *print2dymo* script was modified to work with Linux versions 5, 6, and 7. All the user has to do is comment out or uncomment the appropriate lines. In addition, this script can now print out debugging information.
- The format of the antenna pointing files generated by SKED, and used by NRAO, was modified. Apparently NRAO had been hand editing these files for years. This was not a big issue previously, when the RDV schedules’ recording was **CONTINUOUS**. However, starting with RDV70, NRAO requested that the schedules be generated to use **ADAPTIVE** recording, and the number of changes increased dramatically. These pointing files will no longer need to be edited.
- There were several other minor bug fixes and enhancements which are covered in the DRUDG release notes.

Plans for the next year include: (1) a documentation update and (2) support for new rack types.

# Haystack Observatory Technology Development Center

*Arthur Niell, Alan Whitney*

## Abstract

Work at the MIT Haystack Observatory is currently focusing on three areas of technology development:

- Mark 5C/DBE2 VLBI data system
- VLBI2010 prototype antenna systems
- e-VLBI

Considerable progress has been made in each of these areas.

## 1. Mark 5C VLBI Data System

The Mark 5C is being designed as the next-generation Mark 5 high rate data recording system. It will have the capability of recording at sustained rates up to 4096 Mbps. An important feature is that the same disk modules will be used as for the Mark 5A and Mark 5B, thus preserving the existing investments in storage media.

The Mark 5C data interface for both recording and playback will be 10 Gigabit Ethernet, which is rapidly becoming a widely supported standard. Changing from the hardware-defined VSI-H linkage for the Mark 5B to the network-based interface for the Mark 5C offers both advantages and limitations. For example, data playback through the 10GigE interface is expected to be the natural interface to the large-scale software correlators coming into use. On the other hand, implementing the 10GigE interface requires that the data source must be designed to encapsulate data streams in a format compatible with the Mark 5C requirements. However, in the interest of backward compatibility, the Mark 5C will also support writing the disk modules in Mark 5B format to enable correlation on the existing Mark 4 hardware correlators, although only at 2048 Mbps.

Other characteristics of the Mark 5C include the following.

- The standard Mark 5C is fundamentally a dumb Ethernet packet recorder and is independent of the VLBI data format. We plan to use the VLBI Data Interchange Format (VDIF) as soon as that specification becomes available, and we are designing digital backend equipment which will supply data in the VDIF format.
- The Mark 5C will use the same Amazon StreamStor disk-interface card as the Mark 5B+, but the FPDP I/O daughterboard will be replaced with a 10GigE interface card newly designed (by Conduant Corporation). Unlike Mark 5A/B/B+, no separate, specialized I/O card is needed.
- At data rates above about 2 Gbps, it will be necessary to record simultaneously to two 8-disk modules in so-called ‘non-bank’ mode, which is not normally used by Mark 5A or Mark 5B/B+.

The first prototype Mark 5C systems are expected to be available in mid-2009. Additional information about the Mark 5C systems is available in the Mark 5 memo series at <http://www.haystack.edu/tech/vlbi/mark5/memo.html>, particularly memos 57, 58, 61, and 62.

## 2. Digital Back Ends

Haystack has been using the first-generation digital backend system, dubbed DBE1, very successfully for almost two years. A second-generation system, dubbed DBE2, is being developed at Haystack based on a newer signal processing board, called ROACH (Reconfigurable Open Architecture Computing Hardware). The ROACH board is the product of a consortium consisting of the UC Berkeley CASPER group, NRAO, and the Karoo Array Telescope group in South Africa. This board will be the common platform for digital-backend development to meet the specific needs of both NRAO and Haystack. Haystack will design a polyphase-filter-bank (PFB) version of the FPGA code to process two 1 GHz-wide IFs into an 8 Gbps Ethernet packet stream compatible with the Mark 5C data system. NRAO, on the other hand, is planning to emulate several VLBA BBCs on a ROACH board (dubbed VDBE), which will also produce a Mark 5C-compatible Ethernet data stream. The hardware for both the Haystack and NRAO systems will be identical; only the FPGA code will be different, allowing the same hardware to adopt the personality of either DBE2 or VDBE.

The first prototype DBE2/VDBE systems are expected to be available for testing in mid-2009.

## 3. VLBI2010

The major innovation of the VLBI2010 concept is the use of relatively small and fast-slewing antennas ( $\leq 12$  m) with a receiver spanning a very wide bandwidth ( $\sim 2$ -15 GHz). Observing will utilize four 0.5 to 1 GHz-wide bands spread across the 2-15 GHz receiver capability in order to resolve the more accurate phase delay. This concept has come to be known as the *broadband delay* system.

Haystack Observatory has been working with NASA/GSFC to develop a demonstration system for the broadband delay concept. The basic system was described in the previous Annual Report [1]. In 2007 the first VLBI2010 system was constructed and installed on the 5 m MV-3 antenna at GGAO. Fringes were obtained at X-band between MV-3 and the Westford 18 m antenna. At Westford the standard geodetic S/X circularly polarized feed and receiver were used but with the VLBI2010 backend and recorders. This demonstrated the functionality of the component design.

In 2008 the second VLBI2010 system was completed. It was installed on the Westford antenna for several periods of about two weeks each. Only these periods were available since the Dewar, containing the feed and Low Noise Amplifiers (LNAs), replaces the standard geodetic S/X feed and receiver, and Westford is still used operationally for the IVS geodetic program.

Several improvements were made in 2008.

- To mitigate the interference from digital TV signals near 500 MHz that were saturating the LNAs, filters that pass only frequencies greater than about 3 GHz were installed in the Dewars. Higher quality filters that allow the use of S-band will be incorporated later. To provide additional protection, overload diodes have been installed on all of the LNAs.
- Optical fibers were installed to bring the RF down from the Dewar to the control room. All back-end components were mounted in a single rack (Figure 1).
- Phase calibration has been implemented using geodetic units modified to generate 5 MHz rail spacing. While for early testing the phase cal signal was injected from a probe mounted on the face of the Dewar, the performance improved when the signal was injected via directional



Figure 1. Rack containing a complete VLBI2010 8 gigabit per second data acquisition system. The center chassis contains the optical fiber receivers, splitters, and amplifiers. The four adjacent (silver) chassis with red LED panels are the UpDown Converters. The four black chassis are the Mark 5B+ recorders. The top and bottom chassis are the Digital Back Ends. Each DBE chassis contains two DBE units.

coupler inside the Dewar.

- A digital phase cal generator has been developed and tested but not installed. See Mark 5 memos 56, 59, 60, and 70. This development was necessary because the tunnel diode that provides the pulse in the older phase cal generator is no longer available.
- Software control of the UpDown Converters (UDC) was implemented. This allows the use of a frequency offset to move the phase cal tones off of even-MHz as seen by the Digital Back End (DBE), and it reduces contamination of the phase cal by spurious signals.
- Many scripts were created to simplify the observing procedures since, for each of the four UDCs, DBEs, and Mark 5B+s, some amount of monitoring and control must be incorporated.

After the focus setting at Westford was optimized at 4 GHz, observations were attempted over the frequency range 3.4 GHz to 10 GHz. However, it appears that the optimum setting for 4 GHz is out of focus for the higher frequencies, and fringes were found only below 7 GHz. Subsequently at MV-3, satellite signals at 4, 8, and 11 GHz were used to try to optimize the focus, but the sensitivity did not vary significantly over the available range of focus motion. This is thought to be due to the non-matching subreflector shape for the paraboloidal primary surface.

#### 4. e-VLBI Development

Haystack Observatory continues to support e-VLBI development for VLBI data transfers:

- *Upgrade of 10GigE connection to Haystack:* A 10 Gigabit network connection from Washington, D.C., to Haystack over the Bossnet network was inaugurated in 2007 in cooperation with MIT Lincoln Laboratory, and it is currently being upgraded with new equipment. This link

is important for e-VLBI data transfers to Haystack and for the broadband system demonstrations utilizing the Westford 18 m and the MV-3 5 m antennas.

- *Real-time e-VLBI processing of Mark 5B data:* Work to support real-time e-VLBI using Mark 5B on the Mark IV correlator is nearly complete.
- *New connections:* Haystack has been very active in helping to specify, support, and test new e-VLBI connections. New connections to the USNO correlator and to the Kokee, Hawaii site are expected to be completed soon. Testing has begun on the new connection to Fortaleza.

## 5. Acknowledgements

The broadband demonstration system is funded by NASA's Earth Surface and Interior Focus Area through the efforts of John LaBrecque, Chopo Ma, and Herb Frey.

Important contributions were made by all participants: Bruce Whittier, Mike Titus, Jason SooHoo, Dan Smythe, Alan Rogers, Jay Redmond, Mike Poirier, Arthur Niell, Chuck Kodak, Alan Hinton, Ed Himwich, Skip Gordon, Mark Evangelista, Irv Diegel, Brian Corey, Tom Clark, and Chris Beaudoin.

In addition, the system could not have been put together without the work of Sandy Weinreb and Hamdi Mani of Caltech, whose design of the Dewar, feed, and LNAs has been copied directly. Beyond that, they have generously provided advice as we constructed the front end for MV-3. We also want to thank Dan MacMillan, Peter Bolis, Don Sousa, and Dave Fields for their help; Photonics Systems, Inc. and Linear Photonics, Inc. for loaning us the fiber optic link, and Shep Doleman of Haystack for his significant contributions to the successful implementation of the DBE technology.

## References

- [1] Whitney, A. Technology Development Coordinator, In: International VLBI Service for Geodesy and Astrometry, 2007 Annual Report, NASA/TP-2008-214162, D. Behrend and K. D. Baver, (eds.), 26-29, 2008.

# Technology Development Center at NICT

*Kazuhiro Takefuji, Ryuichi Ichikawa, Mamoru Sekido*

## Abstract

National Institute of Information and Communications Technology (NICT) has led the development of the VLBI technique and has been maintaining a high level of activity in both observations and technical developments. This report gives a review of the Technology Development Center (TDC) at NICT and summarizes its recent activities.

## 1. TDC at NICT

National Institute of Information and Communications Technology (NICT) has published the newsletter “IVS NICT-TDC News” (formerly IVS CRL-TDC News) at least once a year in order to report its development of VLBI related technology as an IVS technology development center. The newsletter is available through the Internet at the following URL: <http://www2.nict.go.jp/w/w114/stsi/ivstdc/news-index.html>.

## 2. Staff Members of NICT TDC

Table 1 lists the staff members at NICT who are involved in the VLBI technology development center at NICT.

Table 1. Staff Members of NICT TDC as of December, 2008 (alphabetical).

Name	Work
AMAGAI, Jun	K5/VSSP32, GPS analysis, TWSTFT <sup>1</sup>
HASEGAWA, Shingo	K5/VSSP32, K5/VSI
HOBIGER, Thomas	VLBI analysis, e-VLBI
ICHIKAWA, Ryuichi	MARBLE <sup>2</sup> system, Delta-VLBI, VLBI analysis
ISHII, Atsutoshi	MARBLE system
KAWAI, Eiji	34 m and 11 m antenna systems
KIMURA, Moritaka	Giga-bit system, K5/VSI, Software correlator, e-VLBI
KONDO, Tetsuro <sup>3</sup>	K5/VSSP32, Software correlator, e-VLBI
KOYAMA, Yasuhiro	e-VLBI, VLBI analysis
SEKIDO, Mamoru	e-VLBI, Delta-VLBI, VLBI analysis
TAKEFUJI, Kazuhiro	e-VLBI
TAKIGUCHI, Hiroshi	VLBI analysis, e-VLBI, GPS analysis
TSUTSUMI, Masanori	K5 system, e-VLBI
UMEMIYA, Yuka	Software correlator

<sup>1</sup> TWSTFT: Two-Way Satellite Time and Frequency Transfer

<sup>2</sup> MARBLE: Multiple Antenna Radio-interferometry of Baseline Length Evaluation

<sup>3</sup> On leave at Ajou University, Korea

### 3. Current Status and Activities

#### 3.1. e-VLBI

e-VLBI technology has been intensively developed in recent years. International e-VLBI experiments for ultra-rapid UT1 measurements have been conducted as a pilot project for testing the operational stability of e-VLBI observing and correlation processing. A distributed correlation processing scheme has been developed and has been used for the rapid UT1 measurements. The schematic diagram of the scheme is indicated in Figure 2 of [1]. A record minimum latency of UT1 measurement of less than 4 minutes was achieved on February 22 on the Tsukuba-Onsala baseline with a 256 Mbps data rate. The observing and the correlation was performed by Onsala and GSI. NICT contributed to it by providing an automatic correlation system, automatic Mark III database creation via NetCDF<sup>1</sup> (MK3TOOLS [2]), and an automatic UT1 analysis scheme with OCCAM developed by T. Hobiger. Also we participated in several e-VLBI demonstration events with the K5 data acquisition system (DAS). Flexibility in data format conversion is one of the important aspects of e-VLBI. We developed a series of A/D converters for VLBI (ADS1000, ADS2000, ADS3000), and they can be used for a variety of observation modes. The first Asia-Oceania e-VLBI experiment between Japan, China, and Australia was realized by a combination of the ADS2000 and PC-VSI interfaces. (See Figures 1 and 2.) Additionally a Mark 5B emulator was developed, and international compatibility was further improved.



Figure 1. The ADS2000 can sample 16 baseband channels at the sampling rate of 64 Msps suitable for the bandwidth synthesis.



Figure 2. VSI-card can record high-bandwidth data to commodity PC.

#### 3.2. MARBLE – Contribution to VLBI2010

We are developing a compact VLBI system with a 1.6 m diameter aperture dish in order to provide reference baseline lengths for calibration. (See Figure 3.) The 10 km reference baselines are used to validate surveying instruments such as GPS and EDM and are maintained by the Geographical Survey Institute (GSI) of Japan. The compact VLBI system will be installed at both ends of the reference baseline. We named the system for providing calibration over the reference baseline “Multiple Antenna Radio-interferometry of Baseline Length Evaluation (MARBLE)” [3]. We evaluated a front-end system with a wide-band quad-ridged horn antenna (QRHA/ type 3164-05 ranging 2 GHz - 18 GHz [4]) made by ETS-Lindgren for the compact VLBI system for

<sup>1</sup><http://www.unidata.ucar.edu/software/netcdf/>



installation on the 2.4 m diameter dish at Kashima. We succeeded in performing two geodetic VLBI experiments on a

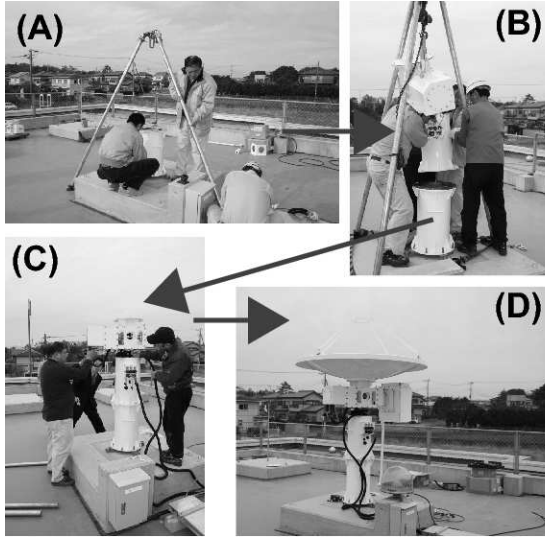

Figure 3. Installation of MARBLE compact VLBI system.

54 km baseline between the 2.4 m dish equipped with the QRHA and the Tsukuba 32 m station of GSI. The results of the determined baseline length between the 2.4 m station and the Tsukuba 32 m station agree well with the previous results which are used by X-band feed only on the 2.4 m dish (this issue of AR of NICT). On the other hand, the formal error of recent results are slightly worse due to low signal-to-noise ratio (SNR) of signal fringes caused by low aperture efficiency of the antenna. Since the new 1.6 m dish is optimized for the new front-end, we expect SNR of the new system will improve. We are now preparing to perform the first fringe detection experiment using the compact VLBI system with the 1.6 m dish in March of 2009.

### 3.3. ADS3000+ — Geodetic VLBI with a Gigabit System

NICT has been developing VLBI observation systems and data processing systems since the 1970s. The K5 VLBI system is designed with commodity products such as personal computers, hard disks, and network components. This strategy has been quite successful for developing highly flexible and high performance observation systems and data processing systems for VLBI. Two independent series of systems, the K5/VSSP (K5/VSSP32) and the K5/VSI systems, have been developed. The concept of the K5/VSSP and K5/VSSP32 systems is to develop A/D sampling units interfaced to the commodity PC systems by using the PCI expansion bus (VSSP) and USB2.0 interface (VSSP32) with simultaneous recording of 16 channels of signals. On the other hand, the K5/VSI series are realized by high speed A/D sampler units and a commodity Linux PC system to record data with the VSI-H (VLBI Standard Interface - Hardware specifications). Three high speed A/D sampler units, ADS1000, ADS2000, and ADS3000, have been developed to support various sampling modes. Currently, a next generation A/D sampler ADS3000+ which supports 4 Gbps \* 1 ch and 2 Gbps \* 2 ch sampling modes with a faster A/D sampler chip was developed in 2008 [5]. (See Figures 4 and 5). ADS3000+ are equipped with FPGA chips to realize a digital baseband converter (DBBC) with a user-selectable bandwidth of 2 to 16 MHz.

## 4. Future Plans

- Geodetic VLBI experiments between two small MARBLEs and a large-aperture antenna to confirm a concept of 10 km length baseline measurement.
- Coding digital baseband conversion of ADS3000+ (16 channel extraction).

- VLBI experiments at 4 Gbit sampling with ADS3000+.

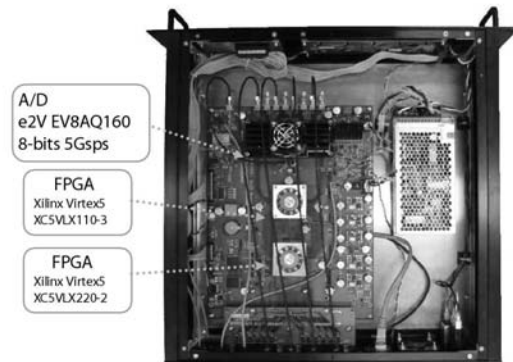

Figure 4. Outside features of ADS3000+. The ADS3000+ has user-friendly interfaces. Initial configuration and control of the ADS3000+ can be done several ways—by pressing buttons, with the network (telnet), and with RS-232C local control.

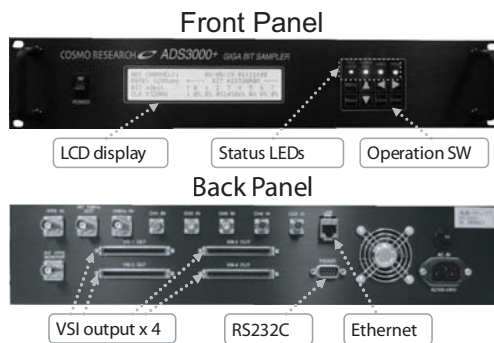

Figure 5. Inside layout of ADS3000+. The ADS3000+ contains a fast A/D converter chip which enables it to sample 4 Gbps \* 1 ch and 2 Gbps \* 2 ch and two FPGAs which can operate quickly and process high-bandwidth data. With these FPGAs, a digital baseband converter can be realized. Therefore, the ADS3000+ already meets VLBI2010 requirements.

## References

- [1] Sekido M., M. Kimura, “VLBI Correlators in Kashima”, International VLBI Service for Geodesy and Astrometry 2008 Annual Report, edited by D. Behrend and K. D. Baver, this issue, 2009.
- [2] Hobiger, T. et al.: “MK3TOOLS & NetCDF – storing VLBI data in a machine independent array oriented data format–”, Proceedings of the 18th European VLBI for Geodesy and Astrometry (EVGA) Working Meeting April 12, 2007, Vienna, Austria, <http://mars.hg.tuwien.ac.at/evga/>, P03, 2007.
- [3] Ichikawa R., A. Ishii, H. Takiguchi, H. Kuboki, M. Kimura, J. Nakajima, Y. Koyama, T. Kondo, M. Machida, S. Kurihara, K. Kokado, and S. Matsuzaka, “Development of a Compact VLBI System for Providing over 10-km Baseline Calibration”, “Measuring The Future”, Proceedings of the Fifth IVS General Meeting, 400–404, 2008.
- [4] Lindgren, ETS-Lindgren (2005). The Model 3164-05 Open Boundary Quadridge Horn, Data Sheet.
- [5] Koyama Y., T. Kondo, M. Sekido, and M. Kimura, Developments of K5/VSI System for Geodetic VLBI Observations, IVS TDC News, No. 29, pp.15-18, 2008.

# Onsala Space Observatory – IVS Technology Development Center

*Rüdiger Haas, Leif Helldner, Miroslav Pantaleev, Johan Löfgren, Gunnar Elgered*

## Abstract

This report summarizes the technical development related to the geodetic VLBI activities that were performed at the Onsala Space Observatory during 2008. Most of the tasks planned for the year were addressed, and some new tasks were initiated. The focus was on: (1) tests of an analog fiber link for the transfer of VLBI IF-signals, (2) a contribution to the project to develop a dual-polarized broadband Eleven feed for VLBI2010, (3) the superconducting gravimeter, and (4) the development of a GNSS-based tide gauge.

## 1. Test of Analog Fiber for Transfer of VLBI IF-signals

For test purposes an analog fiber link between the receiver in the telescope cabin of the 20 m telescope and the IF-distribution in the VLBI-rack in the control room was installed. Several tests to characterize the fiber link were performed. This included static measurements of attenuation versus frequency and dynamic tests to investigate amplitude and phase variations in the fiber as a function of telescope orientation. Figure 1 shows as an example of phase variations as a function of telescope azimuth and elevation angle, for both the analog fiber and the coaxial cable that is normally used for VLBI. The comparison shows that the analog fiber is more robust with respect to mechanical influences due to telescope motion than the coaxial cable. However, the measurements also showed that the fiber has a temperature dependence that needs to be calibrated. Thus, a calibration device has to be developed before the analog fiber can be used routinely in VLBI observations.

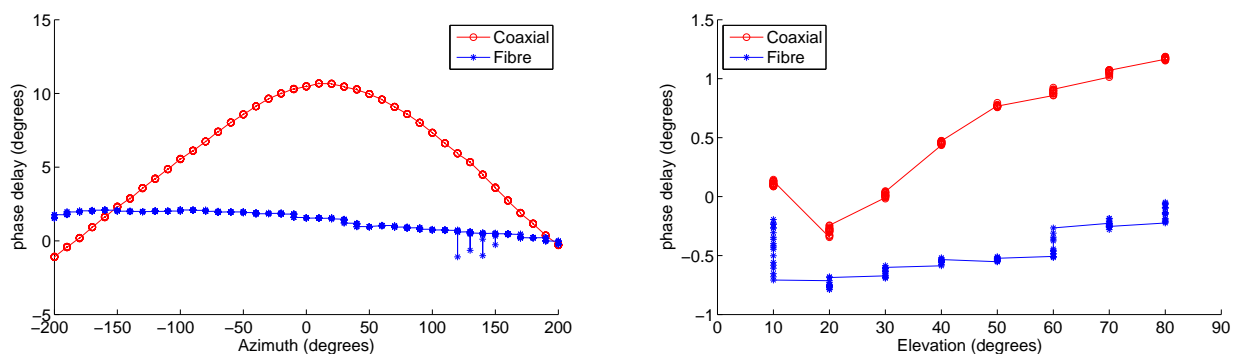

Figure 1. Phase variations as a function of telescope orientation: versus azimuth (left) and versus elevation (right). Red circles show the phase delays for the present coaxial cable, and blue stars represent the results for the analog fiber.

## 2. Mechanical and Thermal Design of an Eleven Feed for VLBI2010

The collaboration with the Antenna Group at the Chalmers University of Technology was intensified during 2008. The intention is to provide the mechanical and thermal design of a prototype for a cooled version of an Eleven Feed [1] that can be used for VLBI2010. The current electrical design covers the frequency range between 2 and 14 GHz. The project includes the mechanical design of the miniature power combiners and impedance transformers located at the center of the antenna and their interface to the low-noise amplifiers. Figure 2 shows examples of the mechanical design and the thermal analysis of Eleven Feed prototypes for VLBI2010. The diameter of the prototype feeds is about 18 cm.

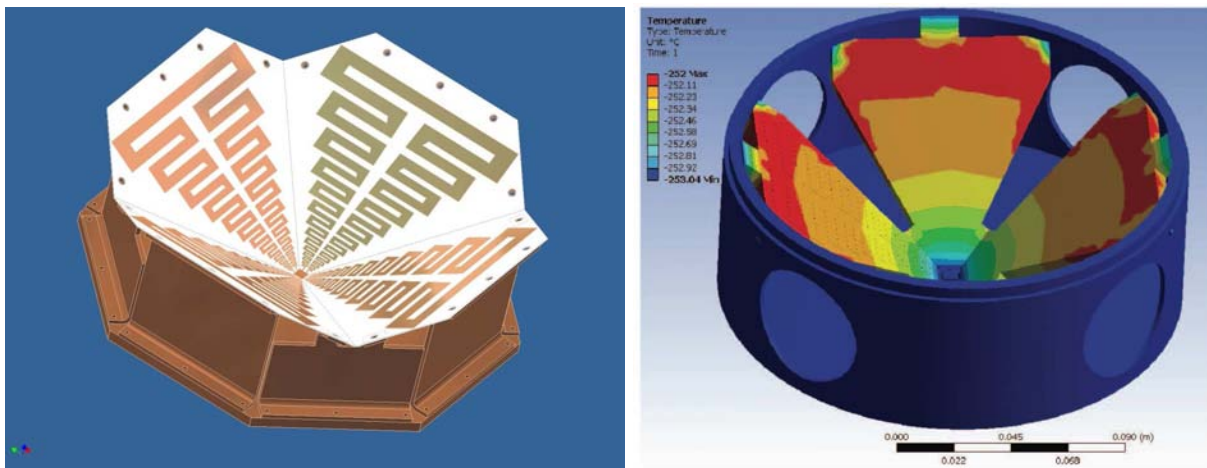

Figure 2. Left: mechanical design of a prototype for an Eleven Feed for VLBI2010. Right: thermal analysis showing the temperature distribution of the feed installed in 20 K cryostat. There is a temperature gradient of about 1 degree Celsius between the center of the feed (coldest) and the outer parts of the feed.

## 3. The Superconducting Gravimeter at Onsala

The construction plans for the measurement cabin of the new gravimeter had to be revised in order to minimize disturbing influences on the instrument and to reduce the amount of necessary ground work. A final construction plan was selected in the summer, and the start of the construction work was postponed until early 2009. The superconducting gravimeter was delivered to Onsala in August.

## 4. Development of a GNSS-based Tide Gauge

During 2008 a project was initiated to measure the local sea level and its variations using GNSS signals. The plan is to install a dual GNSS antenna assembly at the Onsala Space Observatory, one unit directed upward and the other one opposite toward the sea surface. The upward looking antenna is sensitive for right circularly polarized GNSS signals (the usual direction), while the downward looking antenna is sensitive for left circularly polarized GNSS signals. Thus, GNSS

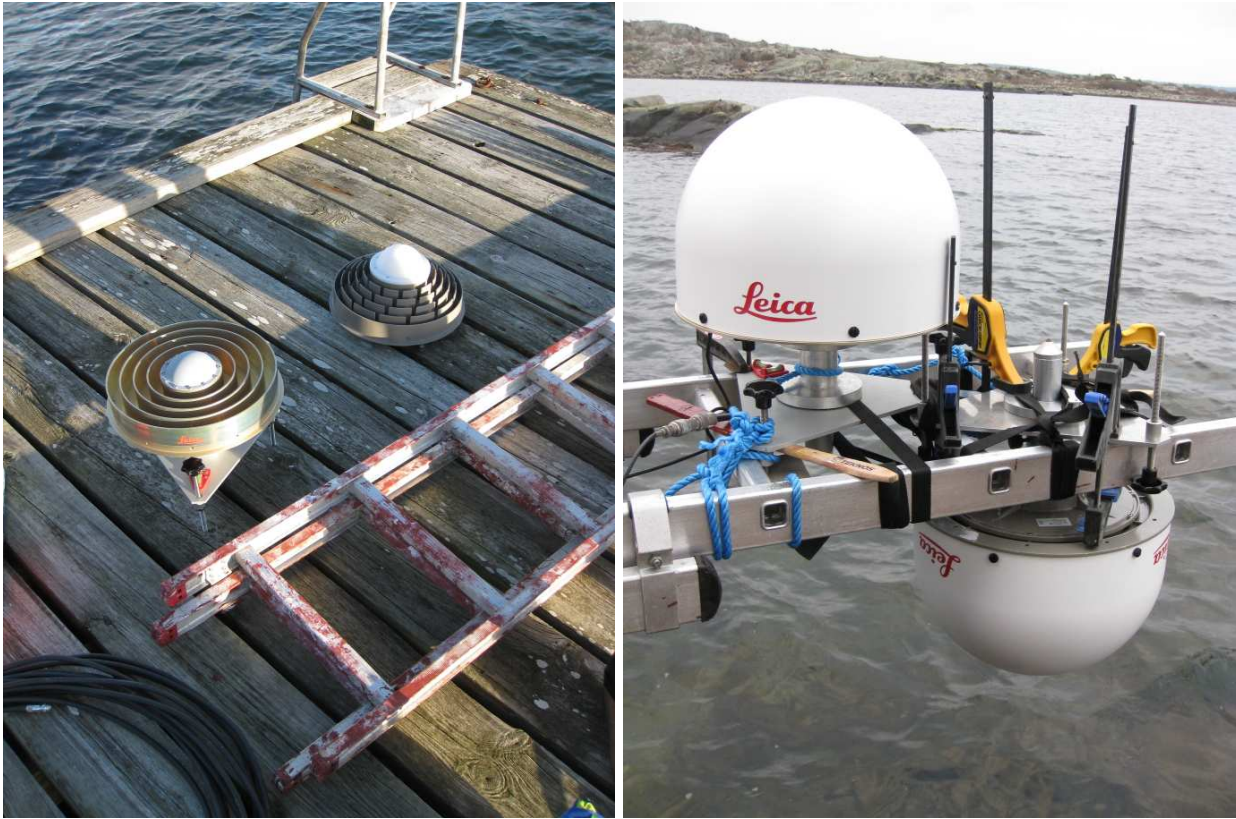

Figure 3. Left: the pair of GNSS antennas used for the GNSS tide gauge project. Right: experimental installation of the pair of upward and downward looking GNSS antennas, now equipped with protecting radomes.

signals from the same satellite are received arriving both directly and after reflection in the sea surface. The analysis of phase measurements performed with the corresponding GNSS receivers will estimate surface height and its variation. The first tests were performed in late 2008. Figure 3 shows the pair of GNSS antennas and their experimental test installation.

## 5. The Microwave Radiometers at Onsala

The microwave radiometer Astrid [2] performed reasonably well during 2008. There were only short periods with problems that were quickly fixed. The data transfer to a processing computer was automated, and a quick-look data analysis is done in an automated fashion. Data sets with a length of 24 hours are analyzed automatically, and the corresponding results are created and plotted automatically. This makes it easier to detect possible problems early.

Our second microwave radiometer Konrad [3] was, however, out of order for almost the whole year due to problems with its azimuth and elevation drives. An attempt to repair Konrad and perform observations at least during CONT08 failed. Konrad was activated for a short time, but the azimuth and elevation drives unfortunately failed for most of the CONT08 sessions. We are

considering carrying out a thorough repair and partial exchange of the drive system during 2009.

## 6. Outlook and Future Plans

- During 2009 we will continue to contribute to the development of a prototype for an Eleven feed for VLBI2010.
- We will install the GNSS-based tide gauge at the Onsala Space Observatory and develop an automated data flow and analysis.
- The new gravimeter house will be completed, and the superconducting gravimeter will be installed during 2009. We will also install various sensors to monitor environmental parameters such as ground water.
- We will try to develop the possibility of reading important parameters of the S/X-receiver directly with the FS.
- We will focus on an upgrade of the azimuth and elevation drives of the Konrad radiometer.
- We plan to equip the time-lab with a Cesium clock, and, in collaboration with the SP Technical Research Institute of Sweden, we plan to develop a time synchronization system via optical fiber.

## References

- [1] Olsson, R., Kildal, P.-S., and Weinreb, S.: The Eleven Antenna: A Compact Low-Profile Decade Bandwidth Dual Polarized Feed for Reflector Antennas, *IEEE Trans. Antennas and Propagation*, **54**(2), 368–375, 2006.
- [2] Elgered, G., and Jarlemark, P.O.J.: Ground-Based Microwave Radiometry and Long-Term Observations of Atmospheric Water Vapor, *Radio Science*, **33**, 707–717, 1998.
- [3] Stoew, B., and Rieck, C.: Dual Channel Water Vapour Radiometer Development. In: W. Schlüter and H. Hase (Eds.): *Proceedings of the 13th Working Meeting on European VLBI for Geodesy and Astrometry*, 261–264, 1999.



---

## Bibliography



## Bibliography





---

## Bibliography

### 1. Introduction

The following bibliography compiles papers that were published in the field of geodetic and astrometric VLBI during the year 2008. There is no distinction between peer-reviewed, reviewed or proceedings publications. This list is by no means exhaustive.

### 2. Geodetic and Astrometric VLBI Publications of 2008

- Y. AILI, N. WANG: “Nanshan VLBI Station Report for 2007”. In: International VLBI Service for Geodesy and Astrometry 2007 Annual Report, edited by D. Behrend and K. Baver, NASA/TP-2008-214162, 106–108, 2008.
- P.H. ANDERSEN: “FFI Analysis Center”. In: International VLBI Service for Geodesy and Astrometry 2007 Annual Report, edited by D. Behrend and K. Baver, NASA/TP-2008-214162, 191–192, 2008.
- P.H. ANDERSEN: “FFI Technology Development Center – Software Development”. In: International VLBI Service for Geodesy and Astrometry 2007 Annual Report, edited by D. Behrend and K. Baver, NASA/TP-2008-214162, 249, 2008.
- T. ARTZ, S. BÖCKMANN, A. NOTHNAGEL, V. TESMER: “Comparison and Validation of VLBI Derived Polar Motion Estimates”. In: “Measuring the Future”, Proceedings of the Fifth IVS General Meeting, edited by A. Finkelstein and D. Behrend, Nauka, Saint Petersburg, ISBN 978-5-02-025332-2, 324–328, 2008.
- C. BARACHE: “Paris Observatory (OPAR) Data Center”. In: International VLBI Service for Geodesy and Astrometry 2007 Annual Report, edited by D. Behrend and K. Baver, NASA/TP-2008-214162, 172–174, 2008.
- D. BEHREND: “Coordinating Center Report”. In: International VLBI Service for Geodesy and Astrometry 2007 Annual Report, edited by D. Behrend and K. Baver, NASA/TP-2008-214162, 13–15, 2008.
- A. BERTARINI, W. ALEF, B. COREY, A. NOTHNAGEL, C. WALKER: “Effects on the Geodetic-VLBI Measurables due to Polarization Leakage in the Receivers”. In: “Measuring the Future”, Proceedings of the Fifth IVS General Meeting, edited by A. Finkelstein and D. Behrend, Nauka, Saint Petersburg, ISBN 978-5-02-025332-2, 53–62, 2008.
- A. BERTARINI, A. MÜSKENS, W. ALEF: “The Bonn Astro/Geo Mark IV Correlator”. In: International VLBI Service for Geodesy and Astrometry 2007 Annual Report, edited by D. Behrend and K. Baver, NASA/TP-2008-214162, 135–138, 2008.
- G. BIANCO, G. COLUCCI, F. SCHIAVONE: “Matera CGS VLBI Station”. In: International VLBI Service for Geodesy and Astrometry 2007 Annual Report, edited by D. Behrend and K. Baver, NASA/TP-2008-214162, 63–66, 2008.
- C. BIZOUARD, O. BECKER: “WEB Tools and WEB Service of the IERS Earth Orientation Centre”. In: “Measuring the Future”, Proceedings of the Fifth IVS General Meeting, edited by A. Finkelstein and D. Behrend, Nauka, Saint Petersburg, ISBN 978-5-02-025332-2, 199–202,

2008.

- D. BOBOLTZ, A. FEY, J. BARTLETT, Z. DUGAN, K. KINGHAM, D. HALL: “U.S. Naval Observatory VLBI Analysis Center”. In: International VLBI Service for Geodesy and Astrometry 2007 Annual Report, edited by D. Behrend and K. Baver, NASA/TP-2008-214162, 238–241, 2008.
- S. BÖCKMANN, A. NOTHNAGEL: “The Variance Component Approach in the IVS Combination”. In: “Measuring the Future”, Proceedings of the Fifth IVS General Meeting, edited by A. Finkelstein and D. Behrend, Nauka, Saint Petersburg, ISBN 978-5-02-025332-2, 329–334, 2008.
- J. BÖHM, P.J. MENDES CERVEIRA, S. ENGLISH, H. SCHUH: “Atmosphere Angular Momentum Time Series for CONT05”. In: “Measuring the Future”, Proceedings of the Fifth IVS General Meeting, edited by A. Finkelstein and D. Behrend, Nauka, Saint Petersburg, ISBN 978-5-02-025332-2, 14–18, 2008.
- S. BOLOTIN, S. LYTVYN: “Comparison of Radio Source Positions from Individual Solutions”. In: “Measuring the Future”, Proceedings of the Fifth IVS General Meeting, edited by A. Finkelstein and D. Behrend, Nauka, Saint Petersburg, ISBN 978-5-02-025332-2, 270–274, 2008.
- S. BOLOTIN, Y. YATSKIV, S. LYTVYN: “IVS Analysis Center at Main Astronomical Observatory of National Academy of Sciences of Ukraine”. In: International VLBI Service for Geodesy and Astrometry 2007 Annual Report, edited by D. Behrend and K. Baver, NASA/TP-2008-214162, 218–219, 2008.
- G. BOURDA, P. CHARLOT, R. PORCAS, S. GARRINGTON: “Multi-step VLBI Observations of Weak Extragalactic Radio Sources to Align the ICRF and the Future GAIA Frame”. In: “Measuring the Future”, Proceedings of the Fifth IVS General Meeting, edited by A. Finkelstein and D. Behrend, Nauka, Saint Petersburg, ISBN 978-5-02-025332-2, 25–29, 2008.
- R. CAMPBELL, A. SZOMORU: “The EVN Mark IV Data Processor at JIVE and e-VLBI Developments in the EVN”. In: “Measuring the Future”, Proceedings of the Fifth IVS General Meeting, edited by A. Finkelstein and D. Behrend, Nauka, Saint Petersburg, ISBN 978-5-02-025332-2, 119–123, 2008.
- N. CAPITAINE, P.M. MATHEWS, V. DEHANT, P.T. WALLACE, S. LAMBERT: “Comparisons of Precession-Nutation Models”. In: “Measuring the Future”, Proceedings of the Fifth IVS General Meeting, edited by A. Finkelstein and D. Behrend, Nauka, Saint Petersburg, ISBN 978-5-02-025332-2, 221–230, 2008.
- D. CHALMERS, G. LACY, P. DEWDNEY, W. PETRACHENKO, G. HOVEY: “Composite Applications for Radio Telescopes”. In: “Measuring the Future”, Proceedings of the Fifth IVS General Meeting, edited by A. Finkelstein and D. Behrend, Nauka, Saint Petersburg, ISBN 978-5-02-025332-2, 371–375, 2008.
- P. CHARLOT: “Astrophysical Stability of Radio Sources and Implication for the Realization of the Next ICRF”. In: “Measuring the Future”, Proceedings of the Fifth IVS General Meeting, edited by A. Finkelstein and D. Behrend, Nauka, Saint Petersburg, ISBN 978-5-02-025332-2, 345–354, 2008.
- P. CHARLOT, A. BELLANGER, G. BOURDA, A. COLLIOD, A. BAUDRY: “Bordeaux Observatory Analysis Center Report”. In: International VLBI Service for Geodesy and Astrometry 2007 Annual Report, edited by D. Behrend and K. Baver, NASA/TP-2008-214162, 181–184, 2008.
- A. COLLIOD, P. CHARLOT: “Imaging Capabilities of the Next Generation VLBI System”. In: “Measuring the Future”, Proceedings of the Fifth IVS General Meeting, edited by A. Finkelstein

- and D. Behrend, Nauka, Saint Petersburg, ISBN 978-5-02-025332-2, 433–438, 2008.
- F. COLOMER, P. DE VICENTE, J. GÓMEZ–GONZÁLEZ, J.A. LÓPEZ–FERNÁNDEZ: “Observatorio Astronómico Nacional – Yebes”. In: International VLBI Service for Geodesy and Astrometry 2007 Annual Report, edited by D. Behrend and K. Baver, NASA/TP-2008-214162, 117–120, 2008.
- L. COMBRINCK, M. NICKOLA: “Hartebeesthoek Radio Astronomy Observatory (HartRAO)”. In: International VLBI Service for Geodesy and Astrometry 2007 Annual Report, edited by D. Behrend and K. Baver, NASA/TP-2008-214162, 45–48, 2008.
- H. DIGRE: “Ny-Ålesund 20 Metre Antenna”. In: International VLBI Service for Geodesy and Astrometry 2007 Annual Report, edited by D. Behrend and K. Baver, NASA/TP-2008-214162, 75–77, 2008.
- K. DOI, K. SHIBUYA: “JARE Syowa Station 11-m Antenna, Antarctica”. In: International VLBI Service for Geodesy and Astrometry 2007 Annual Report, edited by D. Behrend and K. Baver, NASA/TP-2008-214162, 94–97, 2008.
- A. DYAKOV, S. SMOLENTSEV: “Zelenchukskaya Radio Astronomical Observatory”. In: International VLBI Service for Geodesy and Astrometry 2007 Annual Report, edited by D. Behrend and K. Baver, NASA/TP-2008-214162, 121–123, 2008.
- S. ENGLISH, R. HEINKELMANN, H. SCHUH: “Re-assessment of Ocean Tidal Terms in High-Frequency Earth Rotation Variations Observed by VLBI”. In: “Measuring the Future”, Proceedings of the Fifth IVS General Meeting, edited by A. Finkelstein and D. Behrend, Nauka, Saint Petersburg, ISBN 978-5-02-025332-2, 314–318, 2008.
- S. ENGLISH, R. WEBER, H. SCHUH: “Empirical Validation of the Conventional Model for Length of Day Variations due to Zonal Tides”. In: Proceedings of the “Journées Systèmes de Référence Spatio-Temporels 2007”, The Celestial Reference Frame for the Future, edited by N. Capitaine, Observatoire de Paris, ISBN 978-2-901057-59-8, 184–187, 2008.
- A. FEY, D. BOBOLTZ, R. OJHA, R. GAUME, K. KINGHAM: “USNO Analysis Center for Source Structure Report”. In: International VLBI Service for Geodesy and Astrometry 2007 Annual Report, edited by D. Behrend and K. Baver, NASA/TP-2008-214162, 242–244, 2008.
- A. FINKELSTEIN, A. IPATOV, S. SMOLENTSEV: “The Network ‘Quasar’: 2008–2011”. In: “Measuring the Future”, Proceedings of the Fifth IVS General Meeting, edited by A. Finkelstein and D. Behrend, Nauka, Saint Petersburg, ISBN 978-5-02-025332-2, 39–46, 2008.
- A. FINKELSTEIN, E. SKURIKHINA, I. SURKIS, A. IPATOV, I. RAHIMOV, S. SMOLENTSEV: “QUASAR National Programs of EOP Determination”. In: “Measuring the Future”, Proceedings of the Fifth IVS General Meeting, edited by A. Finkelstein and D. Behrend, Nauka, Saint Petersburg, ISBN 978-5-02-025332-2, 319–323, 2008.
- S. GARCÍA-ESPADA, R. HAAS, F. COLOMER: “Space Geodesy at Yebes: Station Motion from VLBI and GPS”. In: “Measuring the Future”, Proceedings of the Fifth IVS General Meeting, edited by A. Finkelstein and D. Behrend, Nauka, Saint Petersburg, ISBN 978-5-02-025332-2, 93–97, 2008.
- I. GAYAZOV, E. SKURIKHINA: “Local Ties between Co-located Space Geodetic Instruments at QUASAR Network Observatories”. In: “Measuring the Future”, Proceedings of the Fifth IVS General Meeting, edited by A. Finkelstein and D. Behrend, Nauka, Saint Petersburg, ISBN 978-5-02-025332-2, 82–86, 2008.

- J. GIPSON: “IVS Working Group 4 on VLBI Data Structures”. In: “Measuring the Future”, Proceedings of the Fifth IVS General Meeting, edited by A. Finkelstein and D. Behrend, Nauka, Saint Petersburg, ISBN 978-5-02-025332-2, 143–152, 2008.
- J. GIPSON, D. MACMILLAN, L. PETROV: “Improved Estimation in VLBI through Better Modeling and Analysis”. In: “Measuring the Future”, Proceedings of the Fifth IVS General Meeting, edited by A. Finkelstein and D. Behrend, Nauka, Saint Petersburg, ISBN 978-5-02-025332-2, 157–162, 2008.
- Y. GNEDIN: “VLBI as a Tool to Connect Astrometry and Astrophysics”. In: “Measuring the Future”, Proceedings of the Fifth IVS General Meeting, edited by A. Finkelstein and D. Behrend, Nauka, Saint Petersburg, ISBN 978-5-02-025332-2, 139–142, 2008.
- A.-M. GONTIER, S. LAMBERT, C. BARACHE: “Paris Observatory Analysis Center OPAR: Report on Activities, January–December 2007”. In: International VLBI Service for Geodesy and Astrometry 2007 Annual Report, edited by D. Behrend and K. Baver, NASA/TP-2008-214162, 224–227, 2008.
- D. GORDON, C. MA, J. GIPSON, L. PETROV, D. MACMILLAN: “On Selection of ‘Defining’ Sources for ICRF-2”. In: “Measuring the Future”, Proceedings of the Fifth IVS General Meeting, edited by A. Finkelstein and D. Behrend, Nauka, Saint Petersburg, ISBN 978-5-02-025332-2, 261–264, 2008.
- D. GORDON, C. MA, D. MACMILLAN, L. PETROV, J. GIPSON, K. BAVER: “GSFC VLBI Analysis Center”. In: International VLBI Service for Geodesy and Astrometry 2007 Annual Report, edited by D. Behrend and K. Baver, NASA/TP-2008-214162, 197–199, 2008.
- V. GUBANOV: “The Phase Variations of Retrograde Free Core Nutation”. In: “Measuring the Future”, Proceedings of the Fifth IVS General Meeting, edited by A. Finkelstein and D. Behrend, Nauka, Saint Petersburg, ISBN 978-5-02-025332-2, 231–235, 2008.
- R. HAAS, G. ELGERED: “The IVS Network Station Onsala Space Observatory”. In: International VLBI Service for Geodesy and Astrometry 2007 Annual Report, edited by D. Behrend and K. Baver, NASA/TP-2008-214162, 82–85, 2008.
- R. HAAS, M. HAGSTRÖM, L.-G. GUNNARSSON, K.-Å. JOHANSSON, M. PANTALEEV, G. ELGERED: “The IVS Technology Development Center at the Onsala Space Observatory”. In: International VLBI Service for Geodesy and Astrometry 2007 Annual Report, edited by D. Behrend and K. Baver, NASA/TP-2008-214162, 261–263, 2008.
- R. HAAS, H.-G. SCHERNECK, T. NILSSON: “The IVS Analysis Center at the Onsala Space Observatory”. In: International VLBI Service for Geodesy and Astrometry 2007 Annual Report, edited by D. Behrend and K. Baver, NASA/TP-2008-214162, 228–231, 2008.
- H. HANADA, T. IWATA, N. KAWANO, N. NAMIKI, K. ASARI, Y. ISHIHARA, T. ISHIKAWA, F. KIKUCHI, Q. LIU, K. MATSUMOTO, H. NODA, S. TSURUTA, S. GOOSSENS, N. PETROVA, S. SASAKI, K. IWADATE, T. JIKE, O. KAMEYA, K. SHIBATA, Y. TAMURA, X. HONG, J. PING, Y. AILI, S. ELLINGSEN, W. SCHLÜTER: “VLBI Observations of SELENE (KAGUYA) by VERA and an International Network”. In: “Measuring the Future”, Proceedings of the Fifth IVS General Meeting, edited by A. Finkelstein and D. Behrend, Nauka, Saint Petersburg, ISBN 978-5-02-025332-2, 445–449, 2008.
- H. HASE, R. DASSING, G. KRONSNABL, W. SCHLÜTER, W. SCHWARZ, R. KILGER, P. LAUBER, A. NEIDHARDT, K. PAUSCH, W. GÖLDI: “Twin Telescope Wettzell: a VLBI2010

- Radio Telescope Project”. In: “Measuring the Future”, Proceedings of the Fifth IVS General Meeting, edited by A. Finkelstein and D. Behrend, Nauka, Saint Petersburg, ISBN 978-5-02-025332-2, 109–113, 2008.
- R. HEINKELMANN, J. BÖHM, H. SCHUH: “Effects of Surface Pressure and Temperature on the VLBI Reference Frame”. In: “Measuring the Future”, Proceedings of the Fifth IVS General Meeting, edited by A. Finkelstein and D. Behrend, Nauka, Saint Petersburg, ISBN 978-5-02-025332-2, 188–192, 2008.
- R. HEINKELMANN, J. BÖHM, H. SCHUH: “Very Long Baseline Interferometry (VLBI) for Climate Studies”. In: Proceedings of the Turkish National Geodetic Commission Scientific Meeting 2007, edited by M.O. Karslioglu, M. Nohutcu and E. Erdogan, 65–71, 2008.
- R. HEINKELMANN, J. FREYMUELLER, H. SCHUH: “A Postseismic Relaxation Model for the 2002 Denali Earthquake from GPS Deformation Analysis Applied to VLBI Data”. In: “Measuring the Future”, Proceedings of the Fifth IVS General Meeting, edited by A. Finkelstein and D. Behrend, Nauka, Saint Petersburg, ISBN 978-5-02-025332-2, 335–340, 2008.
- E. HIMWICH: “Network Coordinator Report”. In: International VLBI Service for Geodesy and Astrometry 2007 Annual Report, edited by D. Behrend and K. Baver, NASA/TP-2008-214162, 18–25, 2008.
- E. HIMWICH, J. GIPSON: “GSFC Technology Development Center Report”. In: International VLBI Service for Geodesy and Astrometry 2007 Annual Report, edited by D. Behrend and K. Baver, NASA/TP-2008-214162, 250–252, 2008.
- T. HOBIGER, R. ICHIKAWA, T. KONDO, Y. KOYAMA: “Fast and Accurate Ray-tracing Algorithms for Real-time Space Geodetic Applications Using Numerical Weather Models”. *Journal of Geophysical Research*, 113, D203027, 1–14, 2008. doi:10.1029/2008JD010503
- T. HOBIGER, R. ICHIKAWA, Y. KOYAMA, T. KONDO: “Real-time Ray-tracing through Numerical Weather Models for Space Geodesy”. *IVS NICT Technology Development Center News*, No. 29, ISSN 1882-3440, 31–34, October 2008.
- T. HOBIGER, R. ICHIKAWA, Y. KOYAMA, T. KONDO: “Kashima Raytracing Service (KARATS) – On-line Provision of Total Troposphere Slant Delay Corrections for East Asian Sites”. In: Proceedings of the International Symposium on GPS/GNSS 2008, 40–44, 2008.
- T. HOBIGER, R. ICHIKAWA, M. SEKIDO, H. TAKIGUCHI, T. KONDO, Y. KOYAMA: “Analysis Center at National Institute of Information and Communications Technology”. In: International VLBI Service for Geodesy and Astrometry 2007 Annual Report, edited by D. Behrend and K. Baver, NASA/TP-2008-214162, 220–223, 2008.
- T. HOBIGER, R. ICHIKAWA, T. TAKASU, Y. KOYAMA, T. KONDO: “Ray-traced Troposphere Slant Delays for Precise Point Positioning”. *Earth Planets Space*, 60(5), e1–e4, 2008.
- T. HOBIGER, T. KONDO, Y. KOYAMA: “Constrained Simultaneous Algebraic Reconstruction Technique (C-SART) – A New and Simple Algorithm Applied to Ionospheric Tomography”. *Earth Planets Space*, 60(7), 727–735, 2008.
- T. HOBIGER, Y. KOYAMA, T. KONDO: “MK3TOOLS – Seamless Interfaces for the Creation of VLBI Databases from Post-Correlation Output”. In: “Measuring the Future”, Proceedings of the Fifth IVS General Meeting, edited by A. Finkelstein and D. Behrend, Nauka, Saint Petersburg, ISBN 978-5-02-025332-2, 153–156, 2008.

- T. HOBIGER, M. SEKIDO, Y. KOYAMA, T. KONDO: “Integer least-squares adjustment for VLBI”. IVS NICT Technology Development Center News, No. 29, ISSN 1882-3440, 8–11, October 2008.
- X. HONG, Q. FAN, T. AN: “Sheshan VLBI Station Report for 2007”. In: International VLBI Service for Geodesy and Astrometry 2007 Annual Report, edited by D. Behrend and K. Baver, NASA/TP-2008-214162, 86–87, 2008.
- R. ICHIKAWA, M. BEVIS, J. FOSTER, N. MANNOJI: “Evaluation of Anisotropic Mapping Function Using JMA 10-km Spectral Model”. Transactions of the Japan Society for Aeronautical and Space Sciences, 51(171), 16–21, 2008. DOI: 10.2322/tjsass.51.16
- R. ICHIKAWA, T. HOBIGER, Y. KOYAMA, T. KONDO: “Real-Time Ray-Tracing through Numerical Weather Models for Space Geodesy”. In: “Measuring the Future”, Proceedings of the Fifth IVS General Meeting, edited by A. Finkelstein and D. Behrend, Nauka, Saint Petersburg, ISBN 978-5-02-025332-2, 168–172, 2008.
- R. ICHIKAWA, T. HOBIGER, Y. KOYAMA, T. KONDO: “An Evaluation of the Practicability of Current Mapping Functions Using Ray-traced Delays from JMA Mesoscale Numerical Weather Data”. In: Proc. of the International Symposium on GPS/GNSS 2008, 3–7, 2008.
- R. ICHIKAWA, T. HOBIGER, Y. KOYAMA, T. KONDO: “A Comparison between Current Mapping Functions and Ray-traced Slant Delays from JMA Mesoscale Numerical Weather Data”. IVS NICT Technology Development Center News, No. 29, ISSN 1882-3440, 3–7, October 2008.
- R. ICHIKAWA, A. ISHII, H. TAKIGUCHI, H. KUBOKI, M. KIMURA, J. NAKAJIMA, Y. KOYAMA, T. KONDO, M. MACHIDA, S. KURIHARA, K. KOKADO, S. MATSUZAKA: “Development of a Compact VLBI System for Providing over 10 km Baseline Calibration”. In: “Measuring the Future”, Proceedings of the Fifth IVS General Meeting, edited by A. Finkelstein and D. Behrend, Nauka, Saint Petersburg, ISBN 978-5-02-025332-2, 400–404, 2008.
- A. ISHII, R. ICHIKAWA, H. TAKIGUCHI, H. KUBOKI, T. KONDO, Y. KOYAMA, M. MACHIDA, S. KURIHARA: “Current Status of Development of a Compact VLBI System for Providing over 10-km Baseline Calibration”. IVS NICT Technology Development Center News, No. 29, ISSN 1882-3440, 19–22, October 2008.
- A. ISHII, R. ICHIKAWA, H. TAKIGUCHI, H. KUBOKI, M. SEKIDO, Y. KOYAMA, Y. OHUCHI: “Evaluation of a Laser-pumped Cs Gas-cell Frequency Standard on Geodetic VLBI”. J. Geod. Soc. Jpn., 54(4), 259–268, 2008.
- D. IVANOV, A. VYTNOV: “Automatic System for Monitoring Hydrogen Masers in QUASAR VLBI Network”. In: “Measuring the Future”, Proceedings of the Fifth IVS General Meeting, edited by A. Finkelstein and D. Behrend, Nauka, Saint Petersburg, ISBN 978-5-02-025332-2, 77–81, 2008.
- C. JACOBS: “JPL VLBI Analysis Center Report for 2007”. In: International VLBI Service for Geodesy and Astrometry 2007 Annual Report, edited by D. Behrend and K. Baver, NASA/TP-2008-214162, 214–218, 2008.
- C. JACOBS, O. SOVERS: “Extending the ICRF above S/X-band: X/Ka-band Global Astrometric Results”. In: “Measuring the Future”, Proceedings of the Fifth IVS General Meeting, edited by A. Finkelstein and D. Behrend, Nauka, Saint Petersburg, ISBN 978-5-02-025332-2, 284–288, 2008.
- T. JIKE, S. MANABE, Y. TAMURA: “Results from K-band Geodetic VLBI Using VERA”. In: “Measuring the Future”, Proceedings of the Fifth IVS General Meeting, edited by A. Finkelstein

- and D. Behrend, Nauka, Saint Petersburg, ISBN 978-5-02-025332-2, 293–296, 2008.
- T. JIKE, S. MANABE, Y. TAMURA, M. SHIZUGAMI, VERA GROUP: “VERA Geodetic Activities”. In: International VLBI Service for Geodesy and Astrometry 2007 Annual Report, edited by D. Behrend and K. Baver, NASA/TP-2008-214162, 69–71, 2008.
- P. KAUFMANN, A.M. PEREIRA DE LUCENA, C.E. TATEYAMA, F.A.T.F. DA SILVA: “Fortaleza Station Report for 2007”. In: International VLBI Service for Geodesy and Astrometry 2007 Annual Report, edited by D. Behrend and K. Baver, NASA/TP-2008-214162, 37–40, 2008.
- E. KAWAI, J. NAKAJIMA, H. TAKEUCHI, H. KUBOKI, T. KONDO, M. SUZUKI, K. SAITO: “RFI Mitigation at a 2GHz Band by Using a Wide-band High-temperature Superconductor Filter”. *J. Geod. Soc. Jpn.*, 54(4), 31–37, 2008.
- M. KHARINOV, A. MIKHAILOV: “Single Dish Radiometric Observations of Geodetic Sources on Radio Telescopes of the QUASAR Network”. In: “Measuring the Future”, Proceedings of the Fifth IVS General Meeting, edited by A. Finkelstein and D. Behrend, Nauka, Saint Petersburg, ISBN 978-5-02-025332-2, 72–76, 2008.
- R. KILGER, G. KRONSNABL, W. SCHLÜTER: “Fundamentalstation Wettzell – 20m Radiotelescope”. In: International VLBI Service for Geodesy and Astrometry 2007 Annual Report, edited by D. Behrend and K. Baver, NASA/TP-2008-214162, 113–116, 2008.
- K. KIM: “Kokee Park Geophysical Observatory”. In: International VLBI Service for Geodesy and Astrometry 2007 Annual Report, edited by D. Behrend and K. Baver, NASA/TP-2008-214162, 59–62, 2008.
- M. KIMURA: “Development of the Software Correlator for the VERA System III”. IVS NICT Technology Development Center News, No. 29, ISSN 1882-3440, 12–14, October 2008.
- K. KINGHAM, M.S. CARTER: “NEOS Operation Center”. In: International VLBI Service for Geodesy and Astrometry 2007 Annual Report, edited by D. Behrend and K. Baver, NASA/TP-2008-214162, 132, 2008.
- K. KINGHAM, D. HALL: “Washington Correlator”. In: International VLBI Service for Geodesy and Astrometry 2007 Annual Report, edited by D. Behrend and K. Baver, NASA/TP-2008-214162, 155–158, 2008.
- K. KINGHAM, D. HALL: “Equipment Failures, Chronic Station Problems, and RFI: Their Effects on Geodetic VLBI Data”. In: “Measuring the Future”, Proceedings of the Fifth IVS General Meeting, edited by A. Finkelstein and D. Behrend, Nauka, Saint Petersburg, ISBN 978-5-02-025332-2, 47–52, 2008.
- K. KOKADO, M. MORITO, S. KURIHARA, S. MATSUZAKA: “Tsukuba 32-m VLBI Station”. In: International VLBI Service for Geodesy and Astrometry 2007 Annual Report, edited by D. Behrend and K. Baver, NASA/TP-2008-214162, 102–105, 2008.
- T. KONDO, Y. KOYAMA, R. ICHIKAWA, M. SEKIDO: “Technology Development Center at NICT”. In: International VLBI Service for Geodesy and Astrometry 2007 Annual Report, edited by D. Behrend and K. Baver, NASA/TP-2008-214162, 257–260, 2008.
- T. KONDO, Y. KOYAMA, R. ICHIKAWA, M. SEKIDO, E. KAWAI, M. KIMURA: “Development of the K5/VSSP System”. *J. Geod. Soc. Jpn.*, 54(4), 233–248, 2008.
- Y. KOYAMA: “Kashima and Koganei 11-m VLBI Stations”. In: International VLBI Service for Geodesy and Astrometry 2007 Annual Report, edited by D. Behrend and K. Baver, NASA/TP-

- 2008-214162, 55–58, 2008.
- Y. KOYAMA, M. HOSOKAWA, K. IMAMURA, T. IWAMA, S. HAMA, J. AMAGAI, Y. HANADO, R. ICHIKAWA: “Status Report of Time and Frequency Activities at NICT”. In: Proceedings of the Asia-Pacific Workshop on Time and Frequency, Jakarta, Indonesia, 2008.
- Y. KOYAMA, T. KONDO, M. SEKIDO, M. KIMURA: “Developments of K5/VSI System for Geodetic VLBI Observations”. IVS NICT Technology Development Center News, No. 29, ISSN 1882-3440, 15–18, October 2008.
- Y. KOYAMA, T. KONDO, M. SEKIDO, J. NAKAJIMA, M. KIMURA, H. TAKEUCHI: “Adaption of the VLBI Standard Interface to the K5 VLBI System”. *J. Geod. Soc. Jpn.*, 54(4), 249–258, 2008.
- Y. KOYAMA, M. SEKIDO, T. HOBIGER, H. TAKIGUCHI, T. KONDO: “Developments of an Automated Data Processing System for Ultra Rapid dUT1 e-VLBI Sessions”. In: “Measuring the Future”, Proceedings of the Fifth IVS General Meeting, edited by A. Finkelstein and D. Behrend, Nauka, Saint Petersburg, ISBN 978-5-02-025332-2, 405–409, 2008.
- Y. KOYAMA, M. SEKIDO, H. TAKIGUCHI: “Data Center at NICT”. In: International VLBI Service for Geodesy and Astrometry 2007 Annual Report, edited by D. Behrend and K. Bayer, NASA/TP-2008-214162, 168–171, 2008.
- G. KRASINSKY: “Secular Decrease of the Earth’s Ellipticity from the Analysis of VLBI Data of 1984–2006, and the Long-term Systematic Errors of the Precession-Nutation Models IAU2000 and IAU2006”. In: “Measuring the Future”, Proceedings of the Fifth IVS General Meeting, edited by A. Finkelstein and D. Behrend, Nauka, Saint Petersburg, ISBN 978-5-02-025332-2, 211–220, 2008.
- G. KUDRYASHOVA, K. SNAJDROVA, R. WEBER, R. HEINKELMANN, H. SCHUH: “Combination of Nutation Time Series Derived from VLBI and GNSS”. In: “Measuring the Future”, Proceedings of the Fifth IVS General Meeting, edited by A. Finkelstein and D. Behrend, Nauka, Saint Petersburg, ISBN 978-5-02-025332-2, 240–245, 2008.
- S. KURDUBOV, E. SKURIKHINA: “Source Selection for NNR Constraints from Source Position Time Series”. In: “Measuring the Future”, Proceedings of the Fifth IVS General Meeting, edited by A. Finkelstein and D. Behrend, Nauka, Saint Petersburg, ISBN 978-5-02-025332-2, 279–283, 2008.
- S. LAMBERT, F. DELEFLIE, A.-M. GONTIER, P. BERIO, C. BARACHE: “The Astronomical Virtual Observatory and Application to Earth’s Sciences”. In: “Measuring the Future”, Proceedings of the Fifth IVS General Meeting, edited by A. Finkelstein and D. Behrend, Nauka, Saint Petersburg, ISBN 978-5-02-025332-2, 203–206, 2008.
- S. LAMBERT, C. LE PONCIN-LAFITTE: “Measuring the Relativistic Parameter  $\gamma$  Using the Current Geodetic VLBI Data Set”. In: “Measuring the Future”, Proceedings of the Fifth IVS General Meeting, edited by A. Finkelstein and D. Behrend, Nauka, Saint Petersburg, ISBN 978-5-02-025332-2, 341–344, 2008.
- R. LANOTTE, G. BIANCO, C. LUCERI: “Matera CGS VLBI Analysis Center”. In: International VLBI Service for Geodesy and Astrometry 2007 Annual Report, edited by D. Behrend and K. Bayer, NASA/TP-2008-214162, 185–186, 2008.
- R. LANOTTE, M. PIRRI, G. BIANCO: “Matera Site Survey and VLBI Invariant Point Determination”. In: “Measuring the Future”, Proceedings of the Fifth IVS General Meeting, edited by



- 
- A. Finkelstein and D. Behrend, Nauka, Saint Petersburg, ISBN 978-5-02-025332-2, 87–92, 2008.
- G. LANYI, D. BOBOLTZ, P. CHARLOT, A. FEY, E. FOMALONT, B. GELDZAHLER, D. GORDON, C. JACOBS, C. MA, C. NAUDET, J. ROMNEY, O. SOVERS, L. ZHANG: “Astrometry from VLBA Observations at 24 and 43 GHz”. In: “Measuring the Future”, Proceedings of the Fifth IVS General Meeting, edited by A. Finkelstein and D. Behrend, Nauka, Saint Petersburg, ISBN 978-5-02-025332-2, 289–292, 2008.
- J. LI: “SHAO Analysis Center 2007 Annual Report”. In: International VLBI Service for Geodesy and Astrometry 2007 Annual Report, edited by D. Behrend and K. Baver, NASA/TP-2008-214162, 235–237, 2008.
- J. LI: “The Contribution of CVN to the CE-1 Mission”. In: “Measuring the Future”, Proceedings of the Fifth IVS General Meeting, edited by A. Finkelstein and D. Behrend, Nauka, Saint Petersburg, ISBN 978-5-02-025332-2, 193–198, 2008.
- C. MA, D. GORDON, D. MACMILLAN, L. PETROV: “Some Challenges in Developing the Second ICRF”. In: “Measuring the Future”, Proceedings of the Fifth IVS General Meeting, edited by A. Finkelstein and D. Behrend, Nauka, Saint Petersburg, ISBN 978-5-02-025332-2, 251–255, 2008.
- D. MACMILLAN: “Simulation Analysis of the Geodetic Performance of Networks of VLBI2010 Stations”. In: “Measuring the Future”, Proceedings of the Fifth IVS General Meeting, edited by A. Finkelstein and D. Behrend, Nauka, Saint Petersburg, ISBN 978-5-02-025332-2, 416–420, 2008.
- Z. MALKIN: “Influence of Elevation-dependent Weighting on Parameter Estimates: A Case of CONT05”. In: “Measuring the Future”, Proceedings of the Fifth IVS General Meeting, edited by A. Finkelstein and D. Behrend, Nauka, Saint Petersburg, ISBN 978-5-02-025332-2, 178–182, 2008.
- Z. MALKIN: “On Construction of ICRF-2”. In: “Measuring the Future”, Proceedings of the Fifth IVS General Meeting, edited by A. Finkelstein and D. Behrend, Nauka, Saint Petersburg, ISBN 978-5-02-025332-2, 256–260, 2008.
- Z. MALKIN, J. SOKOLOVA, N. MILLER: “PUL IVS Analysis Center Report 2007”. In: International VLBI Service for Geodesy and Astrometry 2007 Annual Report, edited by D. Behrend and K. Baver, NASA/TP-2008-214162, 232–234, 2008.
- Z. MALKIN, O. TITOV: “Optical Characteristics of Astrometric Radio Sources”. In: “Measuring the Future”, Proceedings of the Fifth IVS General Meeting, edited by A. Finkelstein and D. Behrend, Nauka, Saint Petersburg, ISBN 978-5-02-025332-2, 183–187, 2008.
- S. MATSUZAKA, H. SHIGEMATSU, S. KURIHARA, M. MACHIDA, K. KOKADO, D. TANIMOTO: “Ultra-rapid UT1 Measurements with e-VLBI”. In: “Measuring the Future”, Proceedings of the Fifth IVS General Meeting, edited by A. Finkelstein and D. Behrend, Nauka, Saint Petersburg, ISBN 978-5-02-025332-2, 68–71, 2008.
- S. MATSUZAKA, K. WADA, E. IWATA, H. SHIGEMATSU, S. KURIHARA, M. MACHIDA, K. KOKADO, D. TANIMOTO: “The Past Decade of Tsukuba 32-m VLBI Station”. In: “Measuring the Future”, Proceedings of the Fifth IVS General Meeting, edited by A. Finkelstein and D. Behrend, Nauka, Saint Petersburg, ISBN 978-5-02-025332-2, 104–108, 2008.
- S. MATSUZAKA, K. WADA, E. IWATA, H. SHIGEMATSU, S. KURIHARA, M. MACHIDA, K. KOKADO, D. TANIMOTO, K. NOZAWA: “VLBI Activities of Tsukuba 32-m Station and Tsukuba

- Correlator”. In: “Measuring the Future”, Proceedings of the Fifth IVS General Meeting, edited by A. Finkelstein and D. Behrend, Nauka, Saint Petersburg, ISBN 978-5-02-025332-2, 98–103, 2008.
- P.J. MENDES CERVEIRA, S. ENGLISH, H. SCHUH, T. KLÜGEL, A. VELIKOSELTSEV, U. SCHREIBER: “How Can the Wettzell ‘G’ Ringlaser Improve VLBI Measurements of Subdiurnal Earth Rotation Variations?”. In: “Measuring the Future”, Proceedings of the Fifth IVS General Meeting, edited by A. Finkelstein and D. Behrend, Nauka, Saint Petersburg, ISBN 978-5-02-025332-2, 19–24, 2008.
- N. MILLER, Z. MALKIN: “Using Singular Spectrum Analysis for the Investigation of Troposphere Parameters”. In: “Measuring the Future”, Proceedings of the Fifth IVS General Meeting, edited by A. Finkelstein and D. Behrend, Nauka, Saint Petersburg, ISBN 978-5-02-025332-2, 302–306, 2008.
- I. MOLOTOV, M. NECHAEVA, I. FALKOVICH, A. KONOVALENKO, V. AGAPOV, G. TUCCARI, G. PUPILLO, S. MONTEBUGNOLI, G. KHARLAMOV, L. BENNER, V. FATEEV, Y. BURTSEV, A. VOLVACH, X. LIU, V. ORESHKO, I. SHMELDS, P. BOLLI, A. DEMENTIEV, A. ANTIPENKO, N. DUGIN, V. JAZYKOV, D. BEZRUKOV: “Astrometry of the Solar System Bodies with VLBI Radar”. In: “Measuring the Future”, Proceedings of the Fifth IVS General Meeting, edited by A. Finkelstein and D. Behrend, Nauka, Saint Petersburg, ISBN 978-5-02-025332-2, 30–34, 2008.
- K. MOTOGI, Y. WATANABE, K. SORAI, A. HABE, M. HONMA, H. IMAI, A. YAMAUCHI, H. KOBAYASHI, K. FUJISAWA, T. OMODAKA, H. TAKABA, K.M. SHIBATA, T. MINAMIDANI, K. WAKAMATSU, H. SUDOU, E. KAWAI, Y. KOYAMA: “Microstructure and Kinematics of H<sub>2</sub>O Masers in the Massive Star Forming Region IRAS 06061+2151”. *Mon. Not. R. Astron. Soc.*, 390(2), 523–534, 2008.
- T. NAGAYAMA, K. TAKEDA, T. OMODAKA, H. IMAI, S. KAMENO, Y. SOFUE, A. DOI, K. FUJISAWA, A. HABE, M. HONMA, N. KAWAGUCHI, E. KAWAI, H. KOBAYASHI, Y. KOYAMA, Y. MURATA, K. SORAI, H. SUDOU, H. TAKABA, S. TAMURA, K. WAKAMATSU: “H<sub>2</sub>O Maser Outflow from the Red Supergiant Star NML Cygni Observed with Japanese VLBI Network”. *Publ. Astron. Soc. Jpn.*, 60, 1069–1075, 2008.
- M. NEGUSINI, P. SARTI, S. MONTAGUTI: “Italy INAF Data Center Report”. In: *International VLBI Service for Geodesy and Astrometry 2007 Annual Report*, edited by D. Behrend and K. Bayer, NASA/TP-2008-214162, 166–167, 2008.
- M. NEGUSINI, P. SARTI, S. MONTAGUTI, C. ABBONDANZA: “Italy INAF Analysis Center Report”. In: *International VLBI Service for Geodesy and Astrometry 2007 Annual Report*, edited by D. Behrend and K. Bayer, NASA/TP-2008-214162, 212–213, 2008.
- A. NIELL: “MIT Haystack Observatory Analysis Center”. In: *International VLBI Service for Geodesy and Astrometry 2007 Annual Report*, edited by D. Behrend and K. Bayer, NASA/TP-2008-214162, 200–203, 2008.
- T. NILSSON, R. HAAS: “Modeling Tropospheric Delays with Atmospheric Turbulence Models”. In: “Measuring the Future”, Proceedings of the Fifth IVS General Meeting, edited by A. Finkelstein and D. Behrend, Nauka, Saint Petersburg, ISBN 978-5-02-025332-2, 361–370, 2008.
- C. NOLL “CDDIS Data Center Summary for the 2007 IVS Annual Report”. In: *International VLBI Service for Geodesy and Astrometry 2007 Annual Report*, edited by D. Behrend and K. Bayer, NASA/TP-2008-214162, 163–165, 2008.

- A. NOTHNAGEL: “Notes of the 9th IVS Analysis Workshop”. In: “Measuring the Future”, Proceedings of the Fifth IVS General Meeting, edited by A. Finkelstein and D. Behrend, Nauka, Saint Petersburg, ISBN 978-5-02-025332-2, 465–467, 2008.
- A. NOTHNAGEL, A. BERTARINI, C. DULFER, T. ARTZ, J. WAGNER, G. MOLERA, J. RITAKARI: “Comparisons of Correlations Using Disk-Transfer and e-VLBI-Transfer”. In: “Measuring the Future”, Proceedings of the Fifth IVS General Meeting, edited by A. Finkelstein and D. Behrend, Nauka, Saint Petersburg, ISBN 978-5-02-025332-2, 63–67, 2008.
- A. NOTHNAGEL, S. BÖCKMANN, T. ARTZ: “Analysis Coordinator Report”. In: International VLBI Service for Geodesy and Astrometry 2007 Annual Report, edited by D. Behrend and K. Bayer, NASA/TP-2008-214162, 16–17, 2008.
- A. NOTHNAGEL, A. MÜSKENS: “The Bonn Geodetic VLBI Operation Center”. In: International VLBI Service for Geodesy and Astrometry 2007 Annual Report, edited by D. Behrend and K. Bayer, NASA/TP-2008-214162, 127–128, 2008.
- A. NOTHNAGEL, M. ROTHACHER, D. ANGERMANN, T. ARTZ, S. BÖCKMANN, W. BOSCH, H. DREWES, M. GERSTL, R. KELM, M. KRÜGEL, D. KÖNIG, R. KÖNIG, B. MEISEL, H. MÜLLER, B. RICHTER, N. PANAFIDINA, S. RUDENKO, W. SCHWEGMANN, P. STEIGENBERGER, V. TESMER, D. THALLER: “GGOS-D: A German Project on the Integration of Space Geodetic Techniques”. In: Proceedings of the “Journées Systèmes de Référence Spatio-Temporels 2007”, The Celestial Reference Frame for the Future, edited by N. Capitaine, Observatoire de Paris, ISBN 978-2-901057-59-8, 167–168, 2008.
- A. NOTHNAGEL, D. SCHNELL: “The Impact of Polar Motion and Nutation Errors on UT1 Determinations from VLBI Intensive Observations”. *Journal of Geodesy*, 82(12), 863–869, 2008. DOI: 10.1007/s00190-008-0212-2
- A. ORFEI, A. ORLATI, G. MACCAFERRI, F. MANTOVANI: “The Medicina Station Status Report”. In: International VLBI Service for Geodesy and Astrometry 2007 Annual Report, edited by D. Behrend and K. Bayer, NASA/TP-2008-214162, 67–68, 2008.
- A. PANY, J. WRESNIK, J. BÖHM, H. SCHUH: “Vienna VLBI2010 PPP Simulations”. In: “Measuring the Future”, Proceedings of the Fifth IVS General Meeting, edited by A. Finkelstein and D. Behrend, Nauka, Saint Petersburg, ISBN 978-5-02-025332-2, 427–432, 2008.
- S. PASYNOK: “Comparison of the Prediction Force of the Nutation Theories IAU 2000 and ERA-2005”. In: “Measuring the Future”, Proceedings of the Fifth IVS General Meeting, edited by A. Finkelstein and D. Behrend, Nauka, Saint Petersburg, ISBN 978-5-02-025332-2, 236–239, 2008.
- B. PETRACHENKO: “Canadian VLBI Technology Development Center”. In: International VLBI Service for Geodesy and Astrometry 2007 Annual Report, edited by D. Behrend and K. Bayer, NASA/TP-2008-214162, 247–248, 2008.
- B. PETRACHENKO, J. BÖHM, D. MACMILLAN, A. NIELL, A. PANY, A. SEARLE, J. WRESNIK: “VLBI2010 Antenna Slew Rate Study”. In: “Measuring the Future”, Proceedings of the Fifth IVS General Meeting, edited by A. Finkelstein and D. Behrend, Nauka, Saint Petersburg, ISBN 978-5-02-025332-2, 410–415, 2008.
- M. POIRIER: “Westford Antenna”. In: International VLBI Service for Geodesy and Astrometry 2007 Annual Report, edited by D. Behrend and K. Bayer, NASA/TP-2008-214162, 109–112, 2008.
- C.M. RAITERI, M. VILLATA, W.P. CHEN, W.S. HSIAO, O.M. KURTANIDZE, K. NILSSON,

- V.M. LARIONOV, M.A. GURWELL, I. AGUDO, H.D. ALLER, M.F. ALLER, E. ANGELAKIS, A.A. ARKHAROV, U. BACH, M. BOTTCHEER, C.S. BUEMI, P. CALCIDESE, P. CHARLOT, E. FORNE, A. FRASCA, L. FUHRMANN, J. GOMEZ, V.A. HAGEN-THORN, S.G. JORSTAD, G.N. KIMERIDZE, T.P. KRICHBAUM, A. LAHTEENMAKI, L. LANTERI, G. LATEV, J.F. LE CAMPION, C.U. LEE, P. LETO, H.C. LIN, N. MARCHILI, E. MARILLI, A.P. MARSCHER, R. NESCI, E. NIEPPOLA, M.G. NIKOLASHILI, J. OHLERT, E. OVCHAROV, D. PRINCIPE, T. PURSIMO, B. RAGOZZINE, A.C. SADUN, L.A. SIGUA, R.L. SMART, A. STRIGACHEV, L.O. TAKALO, M. TAVANI, C. THUM, M. TORNIKOSKI, C. TRIGILIO, K. UCKERT, G. UMANA, A. VLACHEVA, S. VERCELLONE, A. VOLVACH, H. WIESEMAYER: “The High Activity of 3C 454.3 in Autumn 2007 Monitoring by the WEBT during the AGILE Detection”. *Astronomy & Astrophysics*, 485(2), L17–L20, 2008.
- C.M. RAITERI, M. VILLATA, V.M. LARIONOV, M.F. ALLER, U. BACH, M. GURWELL, O.M. KURTANIDZE, A. LAHTEENMAKI, K. NILSSON, A. VOLVACH, H.D. ALLER, A.A. ARKHAROV, R. BACHEV, M. BÖTTCHER, C.S. BUEMI, P. CALCIDESE, E. COZZI, A. DI PAOLA, M. DOLCI, J.H. FAN, E. FORNE, L. FOSCHINI, A.C. GUPTA, V.A. HAGEN-THORN, M. KADLER, A. KOSTOV, T.P. KRICHBAUM, L. LANTERI, C.-U. LEE, P. LETO, F. MONTAGNI, R. NESCI, M.G. NIKOLASHVILI, J. OHLERT, A. OKSANEN, E. OVCHAROV, P. PAAKKONEN, T. PURSIMO, J.A. ROS, E. SEMKOV, R.L. SMART, A. STRIGACHEV, L.O. TAKALO, K. TORII, M. TORNIKOSKI, C. TRIGILIO, H. TSUNEMI, G. UMANA, A. VALCHEVA: “Radio-to-UV Monitoring of AO 0235+164 by the WEBT and Swift during the 2006–2007 Outburst”. *Astronomy & Astrophysics*, 485(2), 339–347, 2008.
- J. REDMOND, M. EVANGELISTA: “Goddard Geophysical and Astronomical Observatory”. In: *International VLBI Service for Geodesy and Astrometry 2007 Annual Report*, edited by D. Behrend and K. Baver, NASA/TP-2008-214162, 41–44, 2008.
- B. REID, J. DICKEY, J. LOVELL, S. ELLINGSEN: “Hobart, Mt. Pleasant, Station Report for 2007”. In: *International VLBI Service for Geodesy and Astrometry 2007 Annual Report*, edited by D. Behrend and K. Baver, NASA/TP-2008-214162, 49–50, 2008.
- S. ROSAT, S. LAMBERT: “Earth’s Interior from VLBI and Superconducting Gravimeter Data”. In: “Measuring the Future”, *Proceedings of the Fifth IVS General Meeting*, edited by A. Finkelstein and D. Behrend, Nauka, Saint Petersburg, ISBN 978-5-02-025332-2, 246–250, 2008.
- C. RUSZCZYK: “Mark 5C Software Development Program”. In: “Measuring the Future”, *Proceedings of the Fifth IVS General Meeting*, edited by A. Finkelstein and D. Behrend, Nauka, Saint Petersburg, ISBN 978-5-02-025332-2, 395–399, 2008.
- W. SCHLÜTER, C. PLÖTZ, R. WOJZIAK: “German Antarctic Receiving Station (GARS) O’Higgins”. In: *International VLBI Service for Geodesy and Astrometry 2007 Annual Report*, edited by D. Behrend and K. Baver, NASA/TP-2008-214162, 78–81, 2008.
- H. SCHUH, D. BEHREND: “IVS Plans and Perspectives”. In: “Measuring the Future”, *Proceedings of the Fifth IVS General Meeting*, edited by A. Finkelstein and D. Behrend, Nauka, Saint Petersburg, ISBN 978-5-02-025332-2, 3–7, 2008.
- H. SCHUH, J. BÖHM, S. ENGLICH, R. HEINKELMANN, P.J. MENDES CERVEIRA, A. PANY, E. TANIR, K. TEKE, S. TODOROVA, J. WRESNIK: “Vienna IGG Special Analysis Center Annual Report 2007”. In: *International VLBI Service for Geodesy and Astrometry 2007 Annual Report*, edited by D. Behrend and K. Baver, NASA/TP-2008-214162, 208–211, 2008.

- M. SEKIDO, T. KONDO, M. KIMURA, Y. KOYAMA: “VLBI Correlators in Kashima”. In: International VLBI Service for Geodesy and Astrometry 2007 Annual Report, edited by D. Behrend and K. Baver, NASA/TP-2008-214162, 147–150, 2008.
- M. SEKIDO, T. KONDO, J. WAGNER, T. HOBIGER, K. KOKADO, H. TAKIGUCHI, Y. KOYAMA, R. HAAS, J. RITAKARI, S. KURIHARA: “Development of e-VLBI Technologies for Ultra-rapid UT1 Measurement”. IVS NICT Technology Development Center News, No. 29, ISSN 1882-3440, 28–30, October 2008.
- M. SEKIDO, H. TAKIGUCHI, Y. KOYAMA, T. KONDO, R. HAAS, J. WAGNER, J. RITAKARI, S. KURIHARA, K. KOKADO: “Ultra-rapid UT1 Measurement by e-VLBI”. *Earth Planets Space*, 60, 865–870, 2008.
- H. SHIGEMATSU, E. IWATA, M. MACHIDA, K. WADA: “Tsukuba VLBI Correlator”. In: International VLBI Service for Geodesy and Astrometry 2007 Annual Report, edited by D. Behrend and K. Baver, NASA/TP-2008-214162, 151–154, 2008.
- E. SKURIKHINA, S. KURDUBOV, V. GUBANOV, G. KRASINSKY: “IAA VLBI Analysis Center Report 2007”. In: International VLBI Service for Geodesy and Astrometry 2007 Annual Report, edited by D. Behrend and K. Baver, NASA/TP-2008-214162, 204–207, 2008.
- S. SMOLENTSEV, I. RAHIMOV: “Svetloe Radio Astronomical Observatory”. In: International VLBI Service for Geodesy and Astrometry 2007 Annual Report, edited by D. Behrend and K. Baver, NASA/TP-2008-214162, 92–93, 2008.
- S. SMOLENTSEV, R. SERGEEV: “Badary Radio Astronomical Observatory”. In: International VLBI Service for Geodesy and Astrometry 2007 Annual Report, edited by D. Behrend and K. Baver, NASA/TP-2008-214162, 33–36, 2008.
- D. SMYTHE: “Mark 5 Disk Drive Performance and Reliability”. In: “Measuring the Future”, Proceedings of the Fifth IVS General Meeting, edited by A. Finkelstein and D. Behrend, Nauka, Saint Petersburg, ISBN 978-5-02-025332-2, 386–389, 2008.
- S. SOBARZO, C. JARA, E. OÑATE, C. HERRERA, C. VERDUGO, H. HASE, A. BÖER, B. SIERK: “Geodetic Observatory TIGO in Concepción”. In: International VLBI Service for Geodesy and Astrometry 2007 Annual Report, edited by D. Behrend and K. Baver, NASA/TP-2008-214162, 98–101, 2008.
- J. SOKOLOVA, Z. MALKIN: “Comparison and Combination of CRF Catalogs”. In: “Measuring the Future”, Proceedings of the Fifth IVS General Meeting, edited by A. Finkelstein and D. Behrend, Nauka, Saint Petersburg, ISBN 978-5-02-025332-2, 275–278, 2008.
- J. SOUCHAY, A. ANDREI, C. BARACHE, S. BOUQUILLON, A.-M. GONTIER, S. LAMBERT, C. LE PONCIN-LAFITTE, F. TARIS, E.F. ARIAS, D. SUCHET, M. BAUDIN: “The Large Quasar Astrometric Catalog and the Radio-Optical Link”. In: “Measuring the Future”, Proceedings of the Fifth IVS General Meeting, edited by A. Finkelstein and D. Behrend, Nauka, Saint Petersburg, ISBN 978-5-02-025332-2, 297–301, 2008.
- I. SURKIS, A. BOGDANOV, A. FATEEV, A. MELNIKOV, V. SHANTYR, V. ZIMOVSKY: “IAA Correlator Center”. In: International VLBI Service for Geodesy and Astrometry 2007 Annual Report, edited by D. Behrend and K. Baver, NASA/TP-2008-214162, 143–146, 2008.
- I. SURKIS, V. ZIMOVSKY, A. MELNIKOV, V. SHANTYR, A. FATEEV, A. BOGDANOV: “The IAA RAS 6-station VLBI Correlator”. In: “Measuring the Future”, Proceedings of the Fifth IVS General Meeting, edited by A. Finkelstein and D. Behrend, Nauka, Saint Petersburg, ISBN

- 978-5-02-025332-2, 124–128, 2008.
- H. TAKIGUCHI, E. KAWAI, H. KUBOKI, T. KONDO: “Kashima 34-m Radio Telescope”. In: International VLBI Service for Geodesy and Astrometry 2007 Annual Report, edited by D. Behrend and K. Baver, NASA/TP-2008-214162, 51–54, 2008.
- H. TAKIGUCHI, Y. KOYAMA: “The 7th NICT IVS-TDC Symposium”. IVS NICT Technology Development Center News, No. 29, ISSN 1882-3440, 1–2, October 2008.
- H. TAKIGUCHI, Y. KOYAMA, R. ICHIKAWA, T. GOTOH, A. ISHII, T. HOBIGER, M. HOSOKAWA: “VLBI Measurements for Frequency Transfer”. In: Proceedings of the Asia-Pacific Workshop on Time and Frequency, Jakarta, Indonesia, 2008.
- H. TAKIGUCHI, Y. KOYAMA, R. ICHIKAWA, T. GOTOH, A. ISHII, T. HOBIGER, M. HOSOKAWA: “VLBI Measurements for Time And Frequency Transfer”. In: Proceedings of 22nd European Frequency and Time Forum, 2008.
- H. TAKIGUCHI, Y. KOYAMA, R. ICHIKAWA, T. GOTOH, A. ISHII, T. HOBIGER, M. HOSOKAWA: “Comparison Study of VLBI and GPS Carrier Phase Frequency Transfer using IVS and IGS data”. IVS NICT Technology Development Center News, No. 29, ISSN 1882-3440, 23–27, October 2008.
- K. TEKE, R. HEINKELMANN, J. BÖHM, H. SCHUH: “VLBI Baseline Length Repeatability Tests of IVS-R1 and IVS-R4 Session Types”. In: “Measuring the Future”, Proceedings of the Fifth IVS General Meeting, edited by A. Finkelstein and D. Behrend, Nauka, Saint Petersburg, ISBN 978-5-02-025332-2, 173–177, 2008.
- V. TESMER, J. BÖHM, B. MEISEL, M. ROTHACHER, P. STEIGENBERGER: “Atmospheric Loading Coefficients Determined from Homogeneously Reprocessed GPS and VLBI Height Time Series”. In: “Measuring the Future”, Proceedings of the Fifth IVS General Meeting, edited by A. Finkelstein and D. Behrend, Nauka, Saint Petersburg, ISBN 978-5-02-025332-2, 307–313, 2008.
- V. TESMER, H. DREWES, M. KRÜGEL: “DGFI Analysis Center Annual Report 2007”. In: International VLBI Service for Geodesy and Astrometry 2007 Annual Report, edited by D. Behrend and K. Baver, NASA/TP-2008-214162, 187–190, 2008.
- D. THALLER, V. TESMER, M. KRÜGEL, M. ROTHACHER, P. STEIGENBERGER: “Combining VLBI Intensive with GPS Rapid Solutions for Deriving a Stable UT Time Series”. In: “Measuring the Future”, Proceedings of the Fifth IVS General Meeting, edited by A. Finkelstein and D. Behrend, Nauka, Saint Petersburg, ISBN 978-5-02-025332-2, 8–13, 2008.
- C. THOMAS, D. MACMILLAN: “CORE Operation Center Report”. In: International VLBI Service for Geodesy and Astrometry 2007 Annual Report, edited by D. Behrend and K. Baver, NASA/TP-2008-214162, 129–131, 2008.
- V. THORANDT, G. ENGELHARDT, D. ULLRICH: “Data Analysis at BKG in the Frame of IVS”. In: “Measuring the Future”, Proceedings of the Fifth IVS General Meeting, edited by A. Finkelstein and D. Behrend, Nauka, Saint Petersburg, ISBN 978-5-02-025332-2, 163–167, 2008.
- V. THORANDT, A. NOTHNAGEL, G. ENGELHARDT, D. ULLRICH, T. ARTZ, S. BÖCKMANN, M. VENNEBUSCH: “The BKG/IGGB VLBI Analysis Center”. In: International VLBI Service for Geodesy and Astrometry 2007 Annual Report, edited by D. Behrend and K. Baver, NASA/TP-2008-214162, 193–196, 2008.

- V. THORANDT, R. WOJZIAK: “BKG Data Center”. In: International VLBI Service for Geodesy and Astrometry 2007 Annual Report, edited by D. Behrend and K. Baver, NASA/TP-2008-214162, 161–162, 2008.
- O. TITOV: “Geoscience Australia Analysis Center”. In: International VLBI Service for Geodesy and Astrometry 2007 Annual Report, edited by D. Behrend and K. Baver, NASA/TP-2008-214162, 177–180, 2008.
- O. TITOV: “Systematic Effects in Apparent Proper Motions of Radio Sources”. In: “Measuring the Future”, Proceedings of the Fifth IVS General Meeting, edited by A. Finkelstein and D. Behrend, Nauka, Saint Petersburg, ISBN 978-5-02-025332-2, 265–269, 2008.
- O. TITOV, S. GULYAEV, J. LOVELL, J. DICKEY: “Australian – New Zealand Geodetic VLBI Network Project”. In: “Measuring the Future”, Proceedings of the Fifth IVS General Meeting, edited by A. Finkelstein and D. Behrend, Nauka, Saint Petersburg, ISBN 978-5-02-025332-2, 114–118, 2008.
- M. TITUS, R. CAPPALLO, B. COREY, K. DUDEVOIR, A. NIELL, A. WHITNEY: “Haystack Observatory VLBI Correlator”. In: International VLBI Service for Geodesy and Astrometry 2007 Annual Report, edited by D. Behrend and K. Baver, NASA/TP-2008-214162, 139–142, 2008.
- S. TODOROVA, T. HOBIGER, H. SCHUH: “Using the Global Navigation Satellite System and Satellite Altimetry for Combined Global Ionosphere Maps”. *Advances in Space Research*, 42, 727–736, 2008.
- V. TORNATORE, G. TUCCARI, E. WEI: “First Considerations on the Feasibility of GNSS Observations by the VLBI Technique”. In: “Measuring the Future”, Proceedings of the Fifth IVS General Meeting, edited by A. Finkelstein and D. Behrend, Nauka, Saint Petersburg, ISBN 978-5-02-025332-2, 439–444, 2008.
- M. TSUBOI, T. TOSAKI, N. KUNO, K. NAKANISHI, T. SAWADA, T. UMEMOTO, S.A. TRUSHKIN, T. KOTANI, N. KAWAI, Y. KURONO, T. HANDA, K. KOHNO, T. TSUKAGOSHI, O. KAMEYA, H. KOBAYASHI, K. FUJISAWA, A. DOI, T. OMODAKA, H. TAKABA, H. SUDOU, K. WAKAMATSU, Y. KOYAMA, E. KAWAI, N. MOCHIZUKI, Y. MURATA: “The 2006 Radio Outburst of a Microquasar Cyg X-3: Observation and Data”. *Publ. Astron. Soc. Jpn.*, 60, 465–473, 2008.
- G. TUCCARI: “Noto Station Status Report”. In: International VLBI Service for Geodesy and Astrometry 2007 Annual Report, edited by D. Behrend and K. Baver, NASA/TP-2008-214162, 72–74, 2008.
- G. TUCCARI, W. ALEF, A. BERTARINI, S. BUTTACCIO, D. GRAHAM, G. NICOTRA, A. ROY M. WUNDERLICH: “DBBC Development Status”. In: “Measuring the Future”, Proceedings of the Fifth IVS General Meeting, edited by A. Finkelstein and D. Behrend, Nauka, Saint Petersburg, ISBN 978-5-02-025332-2, 376–380, 2008.
- M. VILLATA, C.M. RAITERI, V.M. LARIONOV, O.M. KURTANIDZE, K. NILSSON, M.F. ALLER, M. TORNIKOSKI, A. VOLVACH, H.D. ALLER, A.A. ARKHAROV, P. BELTRAME, G. BHATTA, C.S. BUEMI, M. BOTTCHER, P. CALCIDESE, D. CAROSATI, D. DARIO, A. DIPAOLO, M. DOLCI, E. FORNE, A. FRASCA, V.A. HAGEN-THORN, J. HEIDT, D. HIRIART, M. JELINEK, G.N. KIMERIDZE, T.S. KONSTANTINOVA, E.N. KOPATSKAYA, L. LANTERI, R. LIGUSTRI, E. LINDFORS, A. LAHTEENMAKI, E. MARILLI, E. NIEPPOLA, M.G. NIKOLASHILI, M. PASANEN, B. RAGOZZINE, J.A. ROS, L.A. SIGUA, R.L. SMART, M. SORCIA, L.O. TAKALO, M. TAVANI,

- C. TRIGILIO, R. TURCHETTI, K. UCKERT, G. UMANA, S. VERCELLONE, J.R. WEBB: “Multifrequency Monitoring of the Blazar 0716+714 during the GASP-WEBT-AGILE Campaign of 2007”. *Astronomy & Astrophysics*, 481(2), L79–L82, 2008.
- A.E. VOLVACH, D. GRAHAM: “Simeiz VLBI Station—New Status”. In: *International VLBI Service for Geodesy and Astrometry 2007 Annual Report*, edited by D. Behrend and K. Baver, NASA/TP-2008-214162, 88–91, 2008.
- A.E. VOLVACH, N.N. GOR-KAVYI, A.I. DMYTROTSA, L.S. LEVITSKII: “Regions of the Earth with the Best-pronounced Annual Period of Seismic Activity”. *Bulletin of the Crimean Astrophysical Observatory*, 104(1), 145–149, 2008.
- A.E. VOLVACH, M.G. LARIONOV: “RT-22 CrAO: from Simeiz Sky Search to RadioAstron Sources Sample”. *Bulletin of the Crimean Astrophysical Observatory*, 104(5), 78–84, 2008.
- A.E. VOLVACH, M.G. LARIONOV, N.S. KARDASHEV, A. LAHTEENMAKI, M. TORNİKOSKI, T. HOVATTA, E. NIEPPOLA, I. TORNIAINEN, M.F. ALLER, H.D. ALLER: “Variability of Radio Flux of 0716+714”. “Astronomy and Beyond: Astrophysics, Radioastronomy, Cosmology and Astrobiology”, VIII Gamow’s Odessa Astronomical Summer School-Conference Proceedings, Odessa, Ukraine, 19, 2008.
- A.E. VOLVACH, L.I. MATVEENKO: “RT-22 CrAO – 40 Years of VLBI”. *Bulletin of the Crimean Astrophysical Observatory*, 104(5), 68–77, 2008.
- A.E. VOLVACH, V.A. SAMODUROV, A.M. TOLMACHEV, L.N. VOLVACH, I.A. SUBAEV, G.M. RUDNITSKIY, M.I. PASHCHENKO: “RT-22 CrAO and RT-22 PRAO Investigations of the Maser Sources Variability”. *Radio Physics and Radio Astronomy*, 13(3), 86–91, 2008.
- A.E. VOLVACH, L.N. VOLVACH, N.S. KARDASHEV, M.G. LARIONOV: “Studies of Sources from the WMAP Catalog”. *Astronomy Reports*, 52(6), 429–441, 2008.
- A.E. VOLVACH, L.N. VOLVACH, M.G. LARIONOV, M.F. ALLER, H.D. ALLER, M. VILLATA, C.M. RAITERI: “Blazar 3C 454.3 – The 2004–2007 Outburst in the Optical and Radio Ranges”. In: *Proceedings of the 18th International Conference “Microwave & Telecommunication Technology”*, Sevastopol, Crimea, Ukraine, ISBN 978-966-335-168-1, IEEE Catalog Number CFP08788, 867–868, 2008.
- A.E. VOLVACH, L.N. VOLVACH, M.G. LARIONOV, M.F. ALLER, H.D. ALLER, M. VILLATA, K.M. RAITERI: “Correlations Between the Development of a Flare in the Blazar 3C 454.3 in the Radio and Optical”. *Astronomy Reports*, 52(11), ISSN 1063-7729, 867–874, 2008. DOI: 10.1134/S1063772908110012
- A.E. VOLVACH, L.N. VOLVACH, M.I. RYABOV, A.L. SUHAREV, H.D. ALLER, M.F. ALLER: “Peculiarities of the Flux Density Spectral and Time Variability of the Quasar 3C345 Found through the mm and cm Long-term Data Observations”. *Radio Physics and Radio Astronomy*, Kharkiv, Ukraine, 13(3), 81–85, 2008.
- A.E. VOLVACH, L.N. VOLVACH, M.I. RYABOV, A.L. SUHAREV, H.D. ALLER, M.F. ALLER: “Spectral and Temporal Characteristics of the Flux of Quasar 3C 345 at mm and cm Wavelengths: The ‘Secular’ Changes and the Features of the Cycles of Activity”. In: “Astronomy and Beyond: Astrophysics, Radioastronomy, Cosmology and Astrobiology”, VIII Gamow’s Odessa Astronomical Summer School-Conference Proceedings, Odessa, Ukraine, 19, 2008.
- L.N. VOLVACH, V.M. SHULGA, A.E. VOLVACH: “Some Results of Observations of H<sub>2</sub>O (1.35 cm) Maser Sources Using the RT-22 CrAO in 2007”. In: *Proceedings of the 18th International*



- Conference “Microwave & Telecommunication Technology”, Sevastopol, Crimea, Ukraine, ISBN 978-966-335-168-1, IEEE Catalog Number CFP08788, 856–866, 2008.
- O.E. VOLVACH, L.N. VOLVACH, V.S. BICHKOVA, M.S. KARDASHEV, M.G. LARIONOV, V.V. VLASYUK, O.I. SPIRIDONOVA: “Synchronous Observations of the Intraday Variability of Active Galactic Nuclei in Optical and Radio Ranges”. In: Proceedings of the 18th International Conference “Microwave & Telecommunication Technology”, Sevastopol, Crimea, Ukraine, ISBN 978-966-335-168-1, IEEE Catalog Number CFP08788, 869–871, 2008.
- O.E. VOLVACH, L.N. VOLVACH, V.S. BYCHKOVA, M.S. KARDASHEV, M.G. LARIONOV, V.V. VLASYUK, O.I. SPIRIDONOVA: “Investigations of the Intraday Variability of Active Galactic Nuclei in Optical and Radio Ranges”. *Radio Physics and Radio Astronomy*, Kharkiv, Ukraine, 13(3), 35–42, 2008.
- E. WEI, J. LIU, V. TORNATORE, C. SHI, W. YAN: “On the Space VLBI Mathematical Model with Nutation Parameters”. In: “Measuring the Future”, Proceedings of the Fifth IVS General Meeting, edited by A. Finkelstein and D. Behrend, Nauka, Saint Petersburg, ISBN 978-5-02-025332-2, 455–460, 2008.
- A. WHITNEY: “IVS Technology Coordinator Report”. In: International VLBI Service for Geodesy and Astrometry 2007 Annual Report, edited by D. Behrend and K. Baver, NASA/TP-2008-214162, 26–29, 2008.
- A. WHITNEY: “The Mark 5C VLBI Data System”. In: “Measuring the Future”, Proceedings of the Fifth IVS General Meeting, edited by A. Finkelstein and D. Behrend, Nauka, Saint Petersburg, ISBN 978-5-02-025332-2, 390–394, 2008.
- A. WHITNEY, A. NIELL: “Haystack Observatory Technology Development Center”. In: International VLBI Service for Geodesy and Astrometry 2007 Annual Report, edited by D. Behrend and K. Baver, NASA/TP-2008-214162, 253–256, 2008.
- J. WRRESNIK, J. BÖHM, A. PANY, H. SCHUH: “VLBI2010 Simulations at IGG Vienna”. In: “Measuring the Future”, Proceedings of the Fifth IVS General Meeting, edited by A. Finkelstein and D. Behrend, Nauka, Saint Petersburg, ISBN 978-5-02-025332-2, 421–426, 2008.
- X. ZHANG, W. WEI, Y. XIANG, B. LI, F. SHU, R. ZHU, Z. XU, Z. CHEN, W. WANG, W. ZHENG, Z. XUE, Q. LING, R. ZHAO, J. WANG, Q. FAN, Y. AILI, H. LI, Y. WU, L. CHEN, J. LUO: “Progress of Wideband VLBI Digital System Development at SHAO”. In: “Measuring the Future”, Proceedings of the Fifth IVS General Meeting, edited by A. Finkelstein and D. Behrend, Nauka, Saint Petersburg, ISBN 978-5-02-025332-2, 381–385, 2008.
- V. ZHAROV, L. MATVEENKO: “VLBI and Precise Space Navigation”. In: “Measuring the Future”, Proceedings of the Fifth IVS General Meeting, edited by A. Finkelstein and D. Behrend, Nauka, Saint Petersburg, ISBN 978-5-02-025332-2, 450–454, 2008.
- W. ZHENG, W. LUO: “CVN Software Correlator Development and Applications in the Chinese Lunar Exploration Mission”. In: “Measuring the Future”, Proceedings of the Fifth IVS General Meeting, edited by A. Finkelstein and D. Behrend, Nauka, Saint Petersburg, ISBN 978-5-02-025332-2, 129–133, 2008.





**IVS Information**

**IVS Information**



# IVS Terms of Reference

## 1. Summary

### 1.1. Charter

The International VLBI Service for Geodesy and Astrometry (IVS) is an international collaboration of organizations which operate or support Very Long Baseline Interferometry (VLBI) components. IVS provides a service which supports geodetic and astrometric work on reference systems, Earth science research, and operational activities.

IVS is an official Service of the International Association of Geodesy (IAG).

### 1.2. Objectives

IVS fulfills its charter through the following objectives. The primary objective of IVS is to foster VLBI programs as a joint service. This is accomplished through close coordination to provide high-quality VLBI data and products.

The second objective of IVS is to promote research and development activities in all aspects of the geodetic and astrometric VLBI technique. This objective also supports the integration of new components into IVS. The further education and training of VLBI participants is supported through workshops, reports, electronic network connections, and other means.

The third objective of IVS is to interact with the community of users of VLBI products and to integrate VLBI into a global Earth observing system. IVS interacts closely with the International Earth Rotation Service (IERS) which is tasked by the IAU and IUGG with maintaining the international celestial and terrestrial reference frames and with monitoring Earth rotation.

To meet these objectives, IVS coordinates VLBI observing programs, sets performance standards for VLBI stations, establishes conventions for VLBI data formats and data products, issues recommendations for VLBI data analysis software, sets standards for VLBI analysis documentation, and institutes appropriate VLBI product delivery methods to ensure suitable product quality and timeliness. IVS closely coordinates its activities with the astronomical community because of the dual use of many VLBI facilities and technologies for both astronomy and astrometry/geodesy.

IVS accepts observing proposals for research and operational programs that conform to the IVS objectives.

### 1.3. Data Products

VLBI data products contribute uniquely to these important determinations:

- definition and maintenance of the celestial reference frame
- monitoring universal time (UT1) and length of day (LOD)
- monitoring the coordinates of the celestial pole (nutations and precession)

These results are the foundation of many scientific and practical applications requiring the use of an accurate inertial reference frame, such as high-precision navigation and positioning. IVS provides, through the collaborative efforts of its components, a variety of significant VLBI data products with differing applications, timeliness, detail, and temporal resolution, such as:

- all components of Earth orientation parameters at regular intervals
- terrestrial reference frame
- VLBI data in appropriate formats
- VLBI results in appropriate formats
- local site ties to reference points
- high-accuracy station timing data
- surface meteorology, tropospheric and ionospheric measurements

All VLBI data products are archived in IVS Data Centers and are publicly available.

#### **1.4. Research**

The VLBI data products are used for research in many related areas of geodesy, geophysics, and astrometry, such as:

- UT1 and polar motion excitation (over periods of hours to decades)
- solid Earth interior research (mantle rheology, anelasticity, libration, core modes, nutation/precession)
- characterization of celestial reference frame sources and improvements to the frame
- tidal variations (solid Earth, oceanic, and atmospheric)
- improvements in the terrestrial reference frame, especially in the vertical (scale) component
- climate studies

To support these activities, there are ongoing research efforts whose purpose is to improve and extend the VLBI technique in such areas as:

- improvements in data acquisition and correlation
- refined data analysis techniques
- spacecraft tracking (Earth-orbiting and interplanetary)
- combination of VLBI data and results with other techniques

## **2. Permanent Components**

IVS acquires VLBI data, correlates the data, analyzes the data to produce geodetic, astrometric, and other results, and archives and publicizes data products. IVS accomplishes its goals through the types of permanent components described in this section. IVS will accept proposals at any time for a permanent component. Such proposals will be reviewed by the Directing Board. The seven types of IVS permanent components are:

- Network Stations
- Operation Centers
- Correlators

- Analysis Centers
- Data Centers
- Technology Development Centers
- Coordinating Center

IVS acquires VLBI data, correlates the data, analyzes the data to produce geodetic and astrometric results, and archives and publicizes data products. IVS accomplishes its goals through the operational components described below.

### **2.1. Network Stations**

The IVS observing network consists of high performance VLBI stations.

- Stations can be dedicated to geodesy or have multiple uses (including astronomical observations or satellite tracking applications).
- Stations comply with performance standards for data quality and operational reliability set up by the Directing Board.
- VLBI data acquisition sessions are conducted by groups of Network Stations that are distributed either globally or over a geographical region.

### **2.2. Operation Centers**

The IVS Operation Centers coordinate the routine operations of one or more networks. Operation Center activities include:

- planning network observing programs,
- establishing operating plans and procedures for the stations in the network,
- supporting the network stations in improving their performance,
- making correlator time available at an IVS Correlator,
- generating the detailed observing schedules for use in data acquisition sessions by IVS Network Stations,
- posting the observing schedule to an IVS Data Center for distribution and to the Coordinating Center for archiving.

IVS Operation Centers follow guidelines from the Coordinating Center for timeliness and schedule file formats. Operation Centers cooperate with the Coordinating Center in order to define:

- the annual master observing schedule,
- the use of antenna time,
- tape availability and shipping,
- the use of other community resources.

### 2.3. Correlators

The IVS Correlators process raw VLBI data and station log files following a data acquisition session. Their other tasks are to:

- provide immediate feedback to the Network Stations about problems that are apparent in the data,
- jointly maintain the geodetic/astrometric community's tape pool,
- make processed data available to the Analysis Centers,
- regularly compare processing techniques, models, and outputs to ensure that data from different Correlators are identical.

### 2.4. Analysis Centers

The IVS coordinates VLBI data analysis to provide high-quality products for its users. The analyses are performed by Operational Analysis Centers (hereinafter called Analysis Centers), Associate Analysis Centers, and Combination Centers.

Analysis Centers are committed to produce series of Earth Orientation Parameters (EOP) or series of individual EOP components, without interruption and at a specified time lag to meet IVS requirements. In addition, Analysis Centers produce station coordinates and source positions in regular intervals.

The Analysis Centers place their final results in IVS Data Centers for dissemination to researchers and other users. They adhere to IVS recommendations for the creation of high-quality products and their timely archiving and distribution. Any deviations that an Analysis Center makes from IVS recommendations are properly documented. Analysis Centers provide timely feedback about station performance. In addition to these regular services, Analysis Centers may also perform any task of an Associate Analysis Center.

Associate Analysis Centers are committed to regularly submit specialized products using complete series or subsets of VLBI observing sessions. The analysis is performed for specific purposes as recognized by the Directing Board such as exploitation of VLBI data for new types of results, investigations of regional phenomena, reference frame maintenance, or special determinations of Earth orientation parameters. The Associate Analysis Centers place their final results in IVS Data Centers for dissemination to researchers and other users. They adhere to IVS recommendations for the creation of high-quality products and their timely archiving and distribution. Any deviations that an Associate Analysis Center makes from IVS recommendations are properly documented.

Combination Centers are committed to quality control the submissions of the Analysis Centers to the IVS Data Centers and to produce combination results from the individual submissions as official IVS products. The products include, but are not limited to, EOP time series derived from session-based results for 24-hour network sessions and 1-hour Intensive sessions. The Combination Centers also contribute to the generation of the official IVS input to International Terrestrial Reference Frame (ITRF) computations. The combination work is done in a timely fashion and in close cooperation with the IVS Analysis Coordinator.



## 2.5. Data Centers

The IVS Data Centers are repositories for VLBI observing schedules, station log files, and data products. Data Centers may mirror other Data Centers to make the distribution and maintenance of data more efficient and reliable.

- Data Centers are the primary means of distributing VLBI products to users.
- Data Centers work closely with the Coordinating Center and with the Analysis Centers to ensure that all the information and data required by IVS components are quickly and reliably available.

Data Centers provide the following functions:

- receive and archive schedule files from Operation Centers,
- receive and archive log files and ancillary data files from the Network Stations,
- receive and archive data products from the Analysis Centers,
- provide access and public availability to IVS data products for all users.

## 2.6. Technology Development Centers

The IVS Technology Development Centers contribute to the development of new VLBI technology. They may be engaged in hardware and/or software technology development, or evolve new approaches that will improve the VLBI technique and enhance compatibility with different data acquisition terminals. They will:

- design new hardware,
- investigate new equipment,
- develop new software for operations, processing or analysis,
- generate new information systems,
- develop, test, and document prototypes of new equipment or software,
- assist with deployment, installation, and training for any new approved technology.
- After dissemination of the new hardware or software, the centers may continue to provide maintenance and updating functions.

## 2.7. Coordinating Center

The IVS Coordinating Center is responsible for coordination of both the day-to-day and the long-term activities of IVS, consistent with the directives and policies established by the Directing Board. Specifically, the Coordinating Center monitors, coordinates, and supports the activities of the Network Stations, Operation Centers, Correlators, Data Centers, Analysis Centers, and Technology Development Centers. The Coordinating Center works closely with the Technology Coordinator, the Network Coordinator, and the Analysis Coordinator to coordinate all IVS activities.

The primary functions of the Coordinating Center are to:

- coordinate observing programs approved by the Directing Board,

- maintain the master schedule of observing sessions, coordinating the schedule with astronomical observing programs and with IVS networks,
- foster communications among all components of the IVS,
- define the best use of community resources,
- develop standards for IVS components,
- provide training in VLBI techniques,
- organize workshops and meetings, including an annual IVS technical meeting,
- produce and publish reports of activities of IVS components,
- maintain the IVS information system and archive all documents, standards, specifications, manuals, reports, and publications,
- provide liaison with the IERS, IAG, IAU, FAGS, and other organizations,
- provide the Secretariat of the Directing Board.

### **3. Coordinators**

Specific IVS activities for technology, network data quality, and data products are accomplished through the functions performed by three coordinators: a Network Coordinator, an Analysis Coordinator, and a Technology Coordinator.

#### **3.1. Network Coordinator**

The IVS Network Coordinator is selected by the Directing Board from responses to an open solicitation to all IVS components. The Network Coordinator represents the IVS Networks on the Directing Board and works closely with the Coordinating Center. The Network Coordinator is responsible for stimulating the maintenance of a high quality level in the station operation and data delivery. The Network Coordinator performs the following functions:

- monitors adherence to standards in the network operation,
- participates in the quality control of the data acquisition performance of the network stations,
- tracks data quality and data flow problems and suggests actions to improve the level of performance,

The Network Coordinator works closely with the geodetic and astronomical communities who are using the same network stations for observations. The Coordinator takes a leading role in ensuring the visibility and representation of the Networks.

#### **3.2. Analysis Coordinator**

The IVS Analysis Coordinator is selected by the Directing Board from responses to an open solicitation to the IVS Analysis Centers. The Analysis Coordinator is responsible for coordinating the analysis activities of IVS and for stimulating VLBI product development and delivery. The Analysis Coordinator performs the following functions:

- fosters comparisons of results from different VLBI analysis software packages and different analysis strategies,
- encourages analysis and combination software documentation,
- participates in comparisons of results from different space geodetic techniques,
- monitors Analysis Centers' products for high quality results and for adherence to IVS standards and IERS Conventions,
- ensures that analysis and combination products from all Analysis Centers are archived and available for the scientific community, and
- forms the official products of IVS, as decided by the IVS Directing Board, using a suitable combination of the analysis results submitted by the Analysis Centers.
- supervises the formation of the official IVS products, as decided by the IVS Directing Board, produced by the Combination Centers.

The Analysis Coordinator works closely with the geodetic and astronomical communities who are using some of the same analysis methods and software. The Analysis Coordinator plays a leadership role in the development of methods for distribution of VLBI products so that the products reach the widest possible base of users in a timely manner. The coordinator promotes the use of VLBI products to the broader scientific community and interacts with the IVS Coordinating Center and with the IERS.

### **3.3. Technology Coordinator**

The IVS Technology Coordinator is selected by the Directing Board from responses to an open solicitation to the IVS Technology Development Centers. The Technology Coordinator is responsible for coordinating the new technology activities of IVS and for stimulating advancement of the VLBI technique. The Technology Coordinator performs the following functions:

- maintains cognizance of all current VLBI technologies and ongoing development
- coordinates development of new technology among various IVS components
- helps promulgate new technologies to the geodetic/astrometric community
- strives to ensure the highest degree of global compatibility of VLBI data acquisition systems

The Technology Coordinator works closely with the astronomical community because of the many parallels between the technology development required for both groups.

## **4. Directing Board**

### **4.1. Roles and Responsibilities**

The Directing Board determines policies, adopts standards, and approves the scientific and operational goals for IVS. The Directing Board exercises general oversight of the activities of IVS including modifications to the organization that are deemed appropriate and necessary to maintain efficiency and reliability.

A specific function of the Board is to set scientific goals for the IVS observing program. The Board will establish procedures for external research programs and will review any proposals thus received.

The Board may determine appropriate actions to ensure the quality of the IVS products and that the IVS components maintain the adopted standards.

## 4.2. Membership

The Directing Board consists of appointed members who serve *ex officio*, members elected by the Directing Board, and members elected by the IVS components. The members are:

Appointed members *ex officio*:

- IAG representative
- IAU representative
- IERS representative
- FAGS representative
- Coordinating Center Director

Through a reciprocity agreement between IVS and IERS the IVS serves as the VLBI Technique Center for IERS, and as such its designated representative(s) serve on the IERS Directing Board. In turn, the IERS Directing Board designates a representative to the IVS Directing Board. This arrangement is to assure full cooperation between the two services.

Selected by Directing Board upon review of proposals from IVS Member Organizations:

- Technology, Network, and Analysis Coordinators (3 total)

Elected by Directing Board upon recommendation from the Coordinating Center (see below):

- Members at large (3)

Elected by IVS Components (see below):

- Correlators and Operation Centers representative (1)
- Analysis and Data Centers representative (1)
- Networks representatives (2)
- Technology Development Centers representative (1)

Total number: 16

The five appointed members are considered *ex officio* and are not subject to institutional restrictions. The FAGS representative is a non-voting member in accordance with FAGS requirements.

The five members of the Directing Board who are elected by IVS Permanent Components must each be a member of a different IVS Member Organization. All elected members serve staggered four-year terms once renewable.

At large members are intended to ensure representation on the Directing Board of each of the components of IVS and to balance representation from as many countries and institutions and IVS interests as possible. At large members serve 2-year terms once renewable.

A Board member who departs before the end of his/her term is replaced by a person selected by the Directing Board. The new member will serve until the next official elections. The position will then be filled for a full term.

An individual can only serve two consecutive full terms on the Board in any of the representative and at large positions. Partial terms are not counted to this limit. After two consecutive full terms, the individual becomes eligible again for a position on the Board following a two-year absence.

The three Coordinators are selected by the Directing Board on the basis of proposals from IVS Member Organizations. On a two-thirds vote the Directing Board may call for new proposals for any Coordinator when it determines that a new Coordinator is required. Coordinators are encouraged to give at least three months notice before resigning.

### **4.3. Elections**

Election of Board members by the IVS components shall be conducted by a committee of three Directing Board members, the chair of which is appointed by the chair of the Directing Board. The committee solicits nominations for each representative from the relevant IVS components. For each position, the candidate who receives the largest number of votes from the Associate Members will be elected. In case of a tie the Directing Board will make the decision.

### **4.4. Chair**

The chair is one of the Directing Board members and is elected by the Board for a term of four years with the possibility of reelection for one additional term. The chair is the official representative of IVS to external organizations.

### **4.5. Decisions**

Most decisions by the Board are made by consensus or by simple majority vote of the members present. In case of a tie, the chair shall vote but otherwise does not vote. If a two-thirds quorum is not present, the vote shall be held later by electronic mail. A two-thirds vote of all Board members is required to modify the Terms of Reference, to change the chair, or to change any of the members elected by the Directing Board before the normal term expires.

### **4.6. Meetings**

The Board meets at least annually, or more frequently if meetings are called by the chair or at the request of at least three Board members. The Board will conduct periodic reviews of the IVS organization and its mandate, functions, and components. The reviews should be done every four years.

## **5. Definitions**

### **5.1. Member Organizations**

Organizations that support one or more IVS components are IVS Member Organizations. Individuals associated with IVS Member Organizations may become IVS Associate Members.

## 5.2. Affiliated Organizations

Organizations that cooperate with IVS on issues of common interest, but do not support an IVS component, are IVS Affiliated Organizations. Affiliated Organizations express an interest in establishing and maintaining a strong working association with IVS to mutual benefit. Individuals affiliated with IVS Affiliated Organizations may become IVS Correspondents.

## 5.3. Associate Members

Individuals associated with organizations that support an IVS component may become IVS Associate Members. Associate Members are generally invited to attend non-executive sessions of the Directing Board meetings with voice but without vote. Associate Members take part in the election of the incoming members of the Directing Board representing the IVS components.

## 5.4. Corresponding Members

IVS Corresponding Members are individuals on a mailing list maintained by the Coordinating Center. They do not actively participate in IVS but express interest in receiving IVS publications, wish to participate in workshops or scientific meetings organized by IVS, or generally are interested in IVS activities. Ex officio corresponding members are the following:

- IAG General Secretary
- President of IAG Commission 1 – Reference Frames
- President of IAG Commission 3 Geodynamics and Earth Rotation
- President of IAU Division I – Fundamental Astronomy
- President of IAU Commission 8 – Astrometry
- President of IAU Commission 19 – Rotation of the Earth
- President of IAU Commission 31 – Time
- President of IAU Commission 40 – Radio Astronomy
- President of URSI Commission J – Radio Astronomy

Individuals are accepted as IVS Corresponding Members upon request to the Coordinating Center.

Last modified: 3 June, 2009

## IVS Member Organizations

(alphabetized by country)

Organization	Country
Geoscience Australia	Australia
University of Tasmania	Australia
Vienna University of Technology	Austria
Centro de Rádio Astronomia e Aplicações Espaciais	Brazil
Geodetic Survey Division, Natural Resources Canada	Canada
Dominion Radio Astrophysical Observatory	Canada
Universidad de Concepción	Chile
Instituto Geográfico Militar	Chile
Chinese Academy of Sciences	China
Observatoire de Paris	France
Observatoire de Bordeaux	France
Deutsches Geodätisches Forschungsinstitut	Germany
Bundesamt für Kartographie und Geodäsie	Germany
Forschungseinrichtung Satellitengeodäsie, TU Munich	Germany
Institut für Geodäsie und Geoinformation der Universität Bonn	Germany
Max-Planck-Institut für Radioastronomie	Germany
Istituto di Radioastronomia INAF	Italy
Agenzia Spaziale Italiana	Italy
Geographical Survey Institute	Japan
National Institute of Information and Communications Technology	Japan
National Astronomical Observatory of Japan	Japan
National Institute of Polar Research	Japan
Korea Astronomy and Space Science Institute	Korea
Norwegian Defence Research Establishment	Norway
Norwegian Mapping Authority	Norway
Astronomical Institute of St.-Petersburg University	Russia
Central (Pulkovo) Astronomical Observatory	Russia
Institute of Applied Astronomy	Russia
Sternberg State Astronomical Institute, Lomonosov Moscow State University	Russia
Hartebeesthoek Radio Astronomy Observatory	South Africa
Instituto Geográfico Nacional	Spain
Chalmers University of Technology	Sweden
Main Astronomical Observatory, National Academy of Sciences, Kiev	Ukraine
Laboratory of Radioastronomy of Crimean Astrophysical Observatory	Ukraine
NASA Goddard Space Flight Center	USA
U. S. Naval Observatory	USA
Jet Propulsion Laboratory	USA

## IVS Affiliated Organizations

Organization	Country
Australian National University	Australia
University of New Brunswick	Canada
Satellite Geodetic Observatory	Hungary
Joint Institute for VLBI in Europe (JIVE)	Netherlands
Westerbork Observatory	Netherlands
Auckland University of Technology	New Zealand
National Radio Astronomy Observatory	USA



## IVS Associate Members

Name	Institution	Country	E-mail
Alef, Walter	Max-Planck-Institut für Radioastronomie	Germany	walef@mpifr-bonn.mpg.de
Amagai, Jun	National Institute of Information and Communications Technology	Japan	amagai@nict.go.jp
Andersen, Per Helge	Norwegian Defence Research Establishment	Norway	per-helge.andersen@ffi.no
Andreeva, Tatiana	Institute of Applied Astronomy	Russia	ats@urania.rtf32s.nw.ru
Årdal, Ole Bjørn	Norwegian Mapping Authority	Norway	Ole-Bjorn.Ardal@statkart.no
Artz, Thomas	Institut für Geodäsie und Geoinformation der Universität Bonn	Germany	thomas.artz@uni-bonn.de
Barache, Christophe	Observatoire de Paris	France	Christophe.Barache@obspm.fr
Bartlett, Jennifer	U. S. Naval Observatory	USA	jbartlett@usno.navy.mil
Baudry, Alain	Observatoire de Bordeaux	France	baudry@obs.u-bordeaux1.fr
Bauernfeind, Erhard	Fundamentalstation Wettzell	Germany	bauernfeind@fs.wettzell.de
Baver, Karen	NVI, Inc./GSFC	USA	karen.d.baver@nasa.gov
Beck, Norman	Natural Resources Canada	Canada	beck@nrcan.gc.ca
Behrend, Dirk	NVI, Inc./GSFC	USA	dirk.behrend@nasa.gov
Bellanger, Antoine	Observatoire de Bordeaux	France	bellanger@obs.u-bordeaux1.fr
Berdnikov, Anton	Institute of Applied Astronomy	Russia	
Bergman, Per	Onsala Space Observatory	Sweden	bergman@oso.chalmers.se
Bernhart, Simone	Institut für Geodäsie und Geoinformation der Universität Bonn	Germany	simone@mpifr-bonn.mpg.de
Bertarini, Alessandra	Institut für Geodäsie und Geoinformation der Universität Bonn	Germany	abertari@mpifr-bonn.mpg.de
Bérubé, Mario	Natural Resources Canada	Canada	mario@geod.nrcan.gc.ca
Bianco, Giuseppe	Agenzia Spaziale Italiana	Italy	bianco@asi.it
Bielmaier, Ewald	Fundamentalstation Wettzell	Germany	bielmaier@fs.wettzell.de
Boboltz, David	U. S. Naval Observatory	USA	dboboltz@usno.navy.mil

Name	Institution	Country	E-mail
Böckmann, Sarah	Institut für Geodäsie und Geoinformation der Universität Bonn	Germany	boeckmann@uni-bonn.de
Böhm, Johannes	Institute of Geodesy and Geophysics	Austria	johannes.boehm@tuwien.ac.at
Boer, Armin	BKG/Project TIGO	Chile	armin.boer@bkg.bund.de
Bolotin, Sergei	Main Astronomical Observatory	Ukraine	bolotin@mao.kiev.ua
Booth, Roy	Onsala Space Observatory	Sweden	roy@oso.chalmers.se
Bougeard, Mireille	Observatoire de Paris	France	mireille.bougeard@obspm.fr
Bourda, Geraldine	Observatoire de Bordeaux	France	bourda@obs.u-bordeaux1.fr
Buttaccio, Salvo	Istituto di Radioastronomia INAF	Italy	s.buttaccio@ira.inaf.it
Cappallo, Roger	MIT Haystack Observatory	USA	rcappallo@haystack.mit.edu
Carlson, Brent	Dominion Radio Astrophysical Observatory	Canada	bcarlson@drao.nrc.ca
Carter, Merri Sue	U. S. Naval Observatory	USA	msc@maia.usno.navy.mil
Charlot, Patrick	Observatoire de Bordeaux	France	charlot@obs.u-bordeaux1.fr
Cho, Junggho	Korea Astronomy and Space Science Institute	Korea	jojh@kasi.re.kr
Collioud, Arnaud	Observatoire de Bordeaux	France	collioud@obs.u-bordeaux1.fr
Colomer, Francisco	Instituto Geográfico Nacional	Spain	f.colomer@oan.es
Colucci, Giuseppe	Telespazio SpA	Italy	giuseppe.colucci@telespazio.com
Combrinck, Ludwig	Hartebeesthoek Radio Astronomy Observatory	South Africa	ludwig@bootes.hartrao.ac.za
Conway, John	Onsala Space Observatory	Sweden	jconway@chalmers.se
Corey, Brian	MIT Haystack Observatory	USA	bcorey@haystack.mit.edu
Dassing, Reiner	Bundesamt für Kartographie und Geodäsie	Germany	reiner.dassing@bkg.bund.de
Del Rosso, Domenico	Telespazio SpA	Italy	domenico_delrosso@telespazio.it
de-Vicente, Pablo	Instituto Geográfico Nacional	Spain	p.devicente@oan.es
Dewdney, Peter	Dominion Radio Astrophysical Observatory	Canada	ped@drao.nrc.ca
Diakov, Alexey	Institute of Applied Astronomy	Russia	ipazel@mail.svkchr.ru
Dickey, John	University of Tasmania	Australia	John.Dickey@utas.edu.au
Diegel, Irv	Honeywell TSI	USA	irv.diegel@honeywell-tsi.com
Doi, Koichiro	National Institute of Polar Research	Japan	doi@nipr.ac.jp

Name	Institution	Country	E-mail
Dong, Yousuo	Urumqi Astronomical Observatory	China	dongys@ms.xjb.ac.cn
Drewes, Hermann	Deutsches Geodätisches Forschungsinstitut	Germany	drewes@dgfi.badw.de
Dube, Maurice	Raytheon/GSFC	USA	maurice.p.dube@nasa.gov
Elgered, Gunnar	Onsala Space Observatory	Sweden	kge@chalmers.se
Engelhardt, Gerald	Bundesamt für Kartographie und Geodäsie	Germany	gerald.engelhardt@bkg.bund.de
Engen, Bjørn	Norwegian Mapping Authority	Norway	bjorn.engen@statkart.no
Englich, Sigrid	Institute of Geodesy and Geophysics	Austria	sigrid.englich@tuwien.ac.at
Evangelista, Mark	Honeywell TSI	USA	mark.evangelista@honeywell-tsi.com
Fan, Qingyuan	Shanghai Astronomical Observatory	China	qyfan@center.shao.ac.cn
Fedotov, Leonid	Institute of Applied Astronomy	Russia	flv@ipa.nw.ru
Fey, Alan	U. S. Naval Observatory	USA	afey@usno.navy.mil
Finkelstein, Andrey	Institute of Applied Astronomy	Russia	amf@quasar.ipa.nw.ru
Fukuzaki, Yoshihiro	Geographical Survey Institute	Japan	fukuzaki@gsi.go.jp
Gambis, Daniel	Observatoire de Paris	France	daniel.gambis@obspm.fr
Gaume, Ralph	U. S. Naval Observatory	USA	rgaume@usno.navy.mil
Gipson, John	NVI, Inc./GSFC	USA	john.m.gipson@nasa.gov
Gomez, Frank	Raytheon/GSFC	USA	frank.g.gomez@nasa.gov
Gómez-González, Jesús	Instituto Geográfico Nacional	Spain	gomez@oan.es
Gontier, Anne-Marie	Observatoire de Paris	France	anne-marie.gontier@obspm.fr
Gordon, David	NVI, Inc./GSFC	USA	david.gordon-1@nasa.gov
Govind, Ramesh	Geoscience Australia	Australia	ramesh.govind@ga.gov.au
Gubanov, Vadim	Institute of Applied Astronomy	Russia	gubanov@quasar.ipa.nw.ru
Gulyaev, Sergei	Auckland University of Technology	New Zealand	sergei.gulyaev@aut.ac.nz
Haas, Rüdiger	Onsala Space Observatory	Sweden	rudiger.haas@chalmers.se
Hall, David	U. S. Naval Observatory	USA	dhall@usno.navy.mil
Hammargren, Roger	Onsala Space Observatory	Sweden	rogham@chalmers.se
Hanssen, Rune	Norwegian Mapping Authority	Norway	rune.hanssen@statkart.no
Harms, Matt	Honeywell TSI	USA	kokee@pele.kpgo.hawaii.edu
Hase, Hayo	BKG/Project TIGO	Chile	hayo.hase@bkg.bund.de

Name	Institution	Country	E-mail
Heinkelmann, Robert	Deutsches Geodätisches Forschungsinstitut	Germany	heinkelmann@dgfi.badw.de
Hellndner, Leif	Onsala Space Observatory	Sweden	hellndner@chalmers.se
Herrera, Cristian	TIGO/Universidad de Concepción	Chile	cristian.herrera@tigo.cl
Himwich, Ed	NVI, Inc./GSFC	USA	ed.himwich@nasa.gov
Hirabaru, Masaki	National Institute of Information and Communications Technology	Japan	masaki@nict.go.jp
Hobiger, Thomas	National Institute of Information and Communications Technology	Japan	hobiger@nict.go.jp
Hong, Xiaoyu	Shanghai Astronomical Observatory	China	xhong@center.shao.ac.cn
Honma, Mareki	National Astronomical Observatory of Japan	Japan	honmamr@cc.nao.ac.jp
Huang, Xinyong	Shanghai Astronomical Observatory	China	xhuang@center.shao.ac.cn
Hugentobler, Urs	Fundamentalstation Wettzell	Germany	urs.hugentobler@bv.tu-muenchen.de
Ichikawa, Ryuichi	National Institute of Information and Communications Technology	Japan	richi@nict.go.jp
Ihde, Johannes	Bundesamt für Kartographie und Geodäsie	Germany	johannes.ihde@bkg.bund.de
Ilijin, Gennadiy	Institute of Applied Astronomy	Russia	
Ipatov, Alexander	Institute of Applied Astronomy	Russia	ipatov@ipa.rssi.ru
Ipatova, Irina	Institute of Applied Astronomy	Russia	ipatova@isida.ipa.rssi.ru
Ishii, Atsutoshi	National Institute of Information and Communications Technology	Japan	ishii@nict.go.jp
Ivanov, D.V.	Institute of Applied Astronomy	Russia	
Jacobs, Chris	Jet Propulsion Laboratory	USA	chris.jacobs@jpl.nasa.gov
Jara, Cristóbal	TIGO/Universidad de Concepción	Chile	cristobal.jara@tigo.cl
Jike, Takaaki	National Astronomical Observatory of Japan	Japan	jike@miz.nao.ac.jp
Johansson, Karl-Åke	Onsala Space Observatory	Sweden	karlake@chalmers.se
Johansson, Jan	Onsala Space Observatory	Sweden	jmj@chalmers.se
Johnson, Heidi	MIT Haystack Observatory	USA	hjohnson@haystack.mit.edu
Johnston, Kenneth	U. S. Naval Observatory	USA	kjj@astro.usno.navy.mil
Kaufmann, Pierre	Centro de Rádio Astronomia e Aplicações Espaciais	Brazil	kaufmann@usp.br
Kawaguchi, Noriyuki	National Astronomical Observatory of Japan	Japan	kawagu.nori@nao.ac.jp

Name	Institution	Country	E-mail
Kawai, Eiji	National Institute of Information and Communications Technology	Japan	kawa@nict.go.jp
Kaydanovsky, Michael	Institute of Applied Astronomy	Russia	kmn@isida.ipa.rssi.ru
Kharinov, Mikhail	Institute of Applied Astronomy	Russia	kharinov@ipa.rssi.ru
Kim, Kelly	Honeywell TSI	USA	kelly.kim@honeywell.com
Kimura, Moritaka	National Institute of Information and Communications Technology	Japan	mkimura@nict.go.jp
Kingham, Kerry	U. S. Naval Observatory	USA	kak@cygx3.usno.navy.mil
Kobayashi, Hideyuki	National Astronomical Observatory of Japan	Japan	hideyuki.kobayashi@nao.ac.jp
Kokado, Kensuke	Geographical Survey Institute	Japan	vlbi@gsi.go.jp
Kondo, Tetsuro	National Institute of Information and Communications Technology	Japan	kondo@nict.go.jp
Korkin, Edward	Institute of Applied Astronomy	Russia	korkin@isida.ipa.rssi.ru
Koyama, Yasuhiro	National Institute of Information and Communications Technology	Japan	koyama@nict.go.jp
Krasinsky, George	Institute of Applied Astronomy	Russia	kra@quasar.ipa.nw.ru
Kronschnabl, Gerhard	Bundesamt für Kartographie und Geodäsie	Germany	gerhard.kronschnabl@bkg.bund.de
Kuboki, Hiromitsu	National Institute of Information and Communications Technology	Japan	kuboki@nict.go.jp
Kudryashova, Maria	Astronomical Institute of St.-Petersburg	Russia	kudryashova@mercury.astro.spbu.ru
Kurdubov, Sergey	Institute of Applied Astronomy	Russia	ksl@quasar.ipa.nw.ru
Kurihara, Shinobu	Geographical Survey Institute	Japan	skuri@gsi.go.jp
Labelle, Ruth	SGT/GSFC	USA	ruth.e.labelle@nasa.gov
Lambert, Sebastien	Observatoire de Paris	France	sebastien.lambert@obspm.fr
Langkaas, Line	Norwegian Mapping Authority	Norway	Line.Langkaas@statkart.no
Lanotte, Roberto	Telespazio SpA	Italy	lanotte@asi.it
Lauber, Pierre	Fundamentalstation Wettzell	Germany	lauber@fs.wettzell.de
Lavrov, Alexey	Institute of Applied Astronomy	Russia	
Li, Bing	Shanghai Astronomical Observatory	China	bing@center.shao.ac.cn
Li, Huihua	Shanghai Astronomical Observatory	China	hhl@center.shao.ac.cn
Li, Jinling	Shanghai Astronomical Observatory	China	jll@center.shao.ac.cn

Name	Institution	Country	E-mail
Liang, Shiguang	Shanghai Astronomical Observatory	China	sgliang@center.shao.ac.cn
Lindqvist, Michael	Onsala Space Observatory	Sweden	Michael.Lindqvist@chalmers.se
Liu, Xiang	Urumqi Astronomical Observatory	China	liux@ms.xjb.ac.cn
Long, Jim	Honeywell TSI	USA	jim.long@honeywell-tsi.com
Lonsdale, Colin	MIT Haystack Observatory	USA	clonsdale@haystack.mit.edu
Lowe, Stephen	Jet Propulsion Laboratory	USA	steve.lowe@jpl.nasa.gov
Lucena, Antonio	Centro de Rádio Astronomia e Aplicações Espaciais	Brazil	macilio@roen.inpe.br
Luzum, Brian	U. S. Naval Observatory	USA	bjl@maia.usno.navy.mil
Ma, Chopo	NASA Goddard Space Flight Center	USA	chopo.ma-1@nasa.gov
Maccaferri, Giuseppe	Istituto di Radioastronomia INAF	Italy	g.maccaferri@ira.inaf.it
Machida, Morito	Geographical Survey Institute	Japan	machida@gsi.go.jp
MacMillan, Dan	NVI, Inc./GSFC	USA	daniel.s.macmillan@nasa.gov
Malkin, Zinovy	Pulkovo Observatory	Russia	malkin@gao.spb.ru
Manabe, Seiji	National Astronomical Observatory of Japan	Japan	manabe@miz.nao.ac.jp
Mantovani, Franco	Istituto di Radioastronomia INAF	Italy	f.mantovani@ira.inaf.it
Mardyshkin, Vyacheslav	Institute of Applied Astronomy	Russia	vvm@isida.ipa.rssi.ru
Marshalov, Dmitry	Institute of Applied Astronomy	Russia	
Mathiassen, Geir	Norwegian Mapping Authority	Norway	matgei@statkart.no
Matsuzaka, Shigeru	Geographical Survey Institute	Japan	shigeru@gsi.go.jp
McCarthy, Dennis	U. S. Naval Observatory	USA	dmc@maia.usno.navy.mil
Melnikov, Alexey	Institute of Applied Astronomy	Russia	melnikov@quasar.ipa.nw.ru
Michailov, Andrey	Institute of Applied Astronomy	Russia	agm@isida.ipa.rssi.ru
Miller, Natalia	Pulkovo Observatory	Russia	natmiller@list.ru
Mitchell, Donald	Honeywell TSI	USA	kokee@pele.kpgo.hawaii.edu
Müskens, Arno	Institut für Geodäsie und Geoinformation der Universität Bonn	Germany	mueskens@mpifr-bonn.mpg.de
Mukai, Yasuko	Geographical Survey Institute	Japan	mukai@gsi.go.jp

Name	Institution	Country	E-mail
Nakajima, Junichi	National Institute of Information and Communications Technology	Japan	nakaji@nict.go.jp
Nanni, Mauro	Istituto di Radioastronomia INAF	Italy	m.nanni@ira.inaf.it
Natusch, Tim	Auckland University of Technology	New Zealand	tim.natusch@aut.ac.nz
Negusini, Monia	Istituto di Radioastronomia INAF	Italy	m.negusini@ira.inaf.it
Neidhardt, Alexander	Fundamentalstation Wettzell	Germany	neidhardt@fs.wettzell.de
Nicolson, George	Hartebeesthoek Radio Astronomy Observatory	South Africa	george@bootes.hartrao.ac.za
Niell, Arthur	MIT Haystack Observatory	USA	aniell@haystack.mit.edu
Nielsen, Carl-Petter	Norwegian Mapping Authority	Norway	carl-petter.nielsen@statkart.no
Nikitin, Pavel	Crimean Astrophysical Observatory	Ukraine	nikitin@crao.crimea.ua
Nilsson, Tobias	Onsala Space Observatory	Sweden	tobnil@chalmers.se
Noll, Carey	NASA Goddard Space Flight Center	USA	Carey.Noll@nasa.gov
Nothnagel, Axel	Institut für Geodäsie und Geoinformation der Universität Bonn	Germany	nothnagel@uni-bonn.de
Nozawa, Kentarou	Geographical Survey Institute	Japan	nozawa@gsi.go.jp
Ogaja, Clement	Geoscience Australia	Australia	Clement.Ogaja@ga.gov.au
Ojha, Roopesh	U. S. Naval Observatory	USA	rojha@usno.navy.mil
Olofsson, Hans	Onsala Space Observatory	Sweden	hans.olofsson@chalmers.se
Oñate, Eric	TIGO/Universidad del Bío Bío	Chile	eric.onate@tigo.cl
Orfei, Sandro	Istituto di Radioastronomia INAF	Italy	a.orfei@ira.inaf.it
Pany, Andrea	Institute of Geodesy and Geophysics	Austria	apany@mars.hg.tuwien.ac.at
Petrachenko, William	Natural Resources Canada	Canada	Bill.Petrachenko@nrc-cnrc.gc.ca
Pettersson, Lars	Onsala Space Observatory	Sweden	d8lars@chalmers.se
Plank, Lucia	Institute of Geodesy and Geophysics	Austria	lucia.plank@tuwien.ac.at
Plötz, Christian	Bundesamt für Kartographie und Geodäsie	Germany	christian.ploetz@bkg.bund.de
Poirier, Michael	MIT Haystack Observatory	USA	mpoirier@haystack.mit.edu
Popelar, Josef	Natural Resources Canada	Canada	popelar@geod.emr.ca
Qian, Zhihan	Shanghai Astronomical Observatory	China	qzh@center.shao.ac.cn

Name	Institution	Country	E-mail
Quick, Jonathan	Hartebeesthoek Radio Astronomy Observatory	South Africa	jon@bootes.hartrao.ac.za
Rahimov, Ismail	Institute of Applied Astronomy	Russia	rahimov@urania.rtf32s.nw.ru
Redmond, Jay	Honeywell TSI	USA	jay.redmond@honeywell-tsi.com
Reid, Brett	University of Tasmania	Australia	brett.reid@utas.edu.au
Rekkedal, Svein	Norwegian Mapping Authority	Norway	svein.rekkedal@statkart.no
Richter, Bernd	Bundesamt für Kartographie und Geodäsie	Germany	bernd.richter@bkg.bund.de
Rioja, Maria	Instituto Geográfico Nacional	Spain	mj.rija@oan.es
Ruszczyk, Chester	MIT Haystack Observatory	USA	chester@haystack.mit.edu
Salnikov, Alexander	Institute of Applied Astronomy	Russia	salnikov@isida.ipa.rssi.ru
Sarti, Pierguido	Istituto di Radioastronomia INAF	Italy	p.sarti@ira.inaf.it
Schatz, Raimund	Fundamentalstation Wettzell	Germany	schatz@fs.wettzell.de
Scherneck, Hans-Georg	Onsala Space Observatory	Sweden	hgs@chalmers.se
Schlüter, Wolfgang	Bundesamt für Kartographie und Geodäsie	Germany	Wolfgang.Schlueter@bkg.bund.de
Schuh, Harald	Institute of Geodesy and Geophysics	Austria	harald.schuh@tuwien.ac.at
Schupler, Bruce	Honeywell TSI	USA	bruce.schupler@honeywell-tsi.com
Schwarz, Walter	Bundesamt für Kartographie und Geodäsie	Germany	walter.schwarz@bkg.bund.de
Schwegmann, Wolfgang	Bundesamt für Kartographie und Geodäsie	Germany	wolfgang.schwegmann@bkg.bund.de
Sciarretta, Cecilia	Telespazio SpA	Italy	cecilia@asi.it
Searle, Anthony	Natural Resources Canada	Canada	asearle@NRCan.gc.ca
Sekido, Mamoru	National Institute of Information and Communications Technology	Japan	sekido@nict.go.jp
Seitz, Manuela	Deutsches Geodätisches Forschungsinstitut	Germany	seitz@dgfi.badw.de
Shao, Minghui	Urumqi Astronomical Observatory	China	nanshan@ms.xjb.ac.cn
Shibuya, Kazuo	National Institute of Polar Research	Japan	shibuya@nipr.ac.jp
Shigematsu, Hiromi	Geographical Survey Institute	Japan	vlbi@gsi.go.jp
Shishikin, Alexandr	Institute of Applied Astronomy	Russia	
Shu, Fengchun	Shanghai Astronomical Observatory	China	sfc@center.shao.ac.cn



Name	Institution	Country	E-mail
Skurikhina, Elena	Institute of Applied Astronomy	Russia	sea@quasar.ipa.nw.ru
Smolentsev, Sergey	Institute of Applied Astronomy	Russia	smolen@isida.ipa.rssi.ru
Smythe, Dan	MIT Haystack Observatory	USA	dsmythe@haystack.mit.edu
Sobarzo, Sergio	TIGO/Universidad de Concepción	Chile	sergio.sobarzo@tigo.cl
Sokolova, Yulia	Pulkovo Observatory	Russia	s0lei@yandex.ru
Sousa, Don	MIT Haystack Observatory	USA	dsousa@haystack.mit.edu
Sovers, Ojars	Remote Sensing Analysis Inc.	USA	ojars@rsasys.com
Spicakova, Hana	Institute of Geodesy and Geophysics	Austria	hana@mars.hg.tuwien.ac.at
Stanghellini, Carlo	Istituto di Radioastronomia INAF	Italy	c.stanghellini@ira.inaf.it
Steppe, Alan	Jet Propulsion Laboratory	USA	as@logos.jpl.nasa.gov
Surkis, Igor	Institute of Applied Astronomy	Russia	surkis@isida.ipa.rssi.ru
Takashima, Kazuhiro	Geographical Survey Institute	Japan	takasima@gsi.go.jp
Takiguchi, Hiroshi	National Institute of Information and Communications Technology	Japan	htaki@nict.go.jp
Tamura, Yoshiaki	National Astronomical Observatory of Japan	Japan	tamura@miz.nao.ac.jp
Tanimoto, Daisuke	Geographical Survey Institute	Japan	vlbi@gsi.go.jp
Tanir, Emine	Karadenic Technical University	Turkey	etanir@ktu.edu.tr
Tao, An	Shanghai Astronomical Observatory	China	antao@center.shao.ac.cn
Tateyama, Claudio	Centro de Rádio Astronomia e Aplicações Espaciais	Brazil	tateyama@craam.mackenzie.br
Teke, Kamil	Institute of Geodesy and Geophysics	Austria	kteke@mars.hg.tuwien.ac.at
Thomas, Cynthia	NVI, Inc./GSFC	USA	cynthia.c.thomas@nasa.gov
Thorandt, Volkmar	Bundesamt für Kartographie und Geodäsie	Germany	volkmar.thorandt@bkg.bund.de
Thornton, Bruce	U. S. Naval Observatory	USA	blt@casa.usno.navy.mil
Titov, Oleg	Geoscience Australia	Australia	Oleg.Titov@ga.gov.au
Titus, Mike	MIT Haystack Observatory	USA	mtitus@haystack.mit.edu
Todorova, Sonja	Institute of Geodesy and Geophysics	Austria	stodo@mars.hg.tuwien.ac.at
Tomasi, Paolo	Istituto di Radioastronomia INAF	Italy	tomasi@ira.inaf.it
Trigilio, Corrado	Istituto di Radioastronomia INAF	Italy	ctrigilio@oact.inaf.it

Name	Institution	Country	E-mail
Tsutsumi, Masanori	National Institute of Information and Communications Technology	Japan	tsutsumi@nict.go.jp
Tuccari, Gino	Istituto di Radioastronomia INAF	Italy	g.tuccari@ira.inaf.it
Ullrich, Dieter	Bundesamt für Kartographie und Geodäsie	Germany	dieter.ullrich@bkg.bund.de
Venturi, Tiziana	Istituto di Radioastronomia INAF	Italy	t.venturi@ira.inaf.it
Verdugo, Carlos	TIGO/Universidad de Concepción	Chile	carlos.verdugo@tigo.cl
Vespe, Francesco	Agenzia Spaziale Italiana	Italy	vespe@asi.it
Vityazev, Veniamin	Astronomical Institute of St.-Petersburg	Russia	vityazev@list.ru
Volvach, Alexandr	Crimean Astrophysical Observatory	Ukraine	volvach@crao.crimea.ua
Vytnov, Alexander	Institute of Applied Astronomy	Russia	vytnov@isida.ipa.rssi.ru
Wang, Guangli	Shanghai Astronomical Observatory	China	wgl@center.shao.ac.cn
Wang, Jinqing	Shanghai Astronomical Observatory	China	jqwang@center.shao.ac.cn
Wang, Lingling	Shanghai Astronomical Observatory	China	llwang@center.shao.ac.cn
Wang, Na	Urumqi Astronomical Observatory	China	Na.wang@ms.xjb.ac.cn
Wang, Weixia	Urumqi Astronomical Observatory	China	wangwx@ms.xjb.ac.cn
Wei, Wenren	Shanghai Astronomical Observatory	China	wwr@center.shao.ac.cn
Whitney, Alan	MIT Haystack Observatory	USA	awhitney@haystack.mit.edu
Wojdziak, Reiner	Bundesamt für Kartographie und Geodäsie	Germany	reiner.wojdzia@bkg.bund.de
Wooden, William	U. S. Naval Observatory	USA	wooden.william@usno.navy.mil
Wresnik, Joerg	Institute of Geodesy and Geophysics	Austria	wresnik@mars.hg.tuwien.ac.at
Yatskiv, Yaroslav	Main Astronomical Observatory	Ukraine	yatskiv@mao.kiev.ua
Ye, Shuhua	Shanghai Astronomical Observatory	China	ysh@center.shao.ac.cn
Yusup, Aili	Urumqi Astronomical Observatory	China	aliyu@ms.xjb.ac.cn
Zeitlhofer, Reinhard	Fundamentalstation Wettzell	Germany	zeitlhofer@fs.wettzell.de

---

Name	Institution	Country	E-mail
Zhang, Ali	Urumqi Astronomical Observatory	China	zhangal@uao.ac.cn
Zhang, Jin	Urumqi Astronomical Observatory	China	zhangj@ms.xjb.ac.cn
Zhang, Xiuzhong	Shanghai Astronomical Observatory	China	xzhang@shao.ac.cn
Zhao, Rongbing	Shanghai Astronomical Observatory	China	zhaorb@center.shao.ac.cn
Zheng, Weimin	Shanghai Astronomical Observatory	China	zhwm@shao.ac.cn
Zhou, Ruixian	Shanghai Astronomical Observatory	China	zrx@center.shao.ac.cn

## IVS Permanent Components

(listed by types, within types alphabetical by component name)

### Network Stations

<b>Component Name</b>	<b>Sponsoring Organization</b>	<b>Country</b>
Radioastronomical Observatory Badary	Institute of Applied Astronomy RAS	Russia
Fortaleza, Radio Observatório Espacial do Nordeste (ROEN)	Centro de Rádio Astronomia e Aplicações Espaciais	Brazil
Goddard Geophysical and Astronomical Observatory	NASA Goddard Space Flight Center	USA
Hartebeesthoek Radio Astronomy Observatory	Foundation for Research and Development	South Africa
Hobart, Mt. Pleasant Radio Observatory	University of Tasmania	Australia
Kashima 34m	National Institute of Information and Communications Technology (NICT)	Japan
Key Stone Project Kashima 11m	National Institute of Information and Communications Technology (NICT)	Japan
Key Stone Project Koganei 11m	National Institute of Information and Communications Technology (NICT)	Japan
Kokee Park Geophysical Observatory	National Earth Orientation Service (NEOS)	USA
Matera	Agenzia Spaziale Italiana (ASI)	Italy
Medicina	Istituto di Radioastronomia	Italy
Mizusawa 10m	National Astronomical Observatory of Japan (NAOJ)	Japan
Noto (Sicily)	Istituto di Radioastronomia	Italy
Ny-Ålesund Geodetic Observatory	Norwegian Mapping Authority	Norway
ERS/VLBI Station O'Higgins	Bundesamt für Kartographie und Geodäsie (BKG)	Germany
Onsala Space Observatory	Chalmers University of Technology	Sweden
Seshan	Joint Laboratory for Radio Astronomy (JLRA), CAS and Shanghai Observatory, CAS	China
Simeiz	Laboratory of Radioastronomy of Crimean Astrophysical Observatory	Ukraine
Svetloe Radio Astronomy Observatory	Institute of Applied Astronomy RAS	Russia
JARE Syowa Station	National Institute of Polar Research	Japan

Transportable Integrated Geodetic Observatory (TIGO)	Universidad de Concepción (UdeC), Instituto Geográfico Militar (IGM), Bundesamt für Kartographie und Geodäsie (BKG)	Germany, Chile
Tsukuba VLBI Station	Geographical Survey Institute	Japan
Nanshan VLBI Station	Chinese Academy of Sciences	China
Westford Antenna, Haystack Observatory	NASA Goddard Space Flight Center	USA
Fundamentalstation Wettzell	Bundesamt für Kartographie und Geodäsie (BKG) and Forschungseinrichtung Satellitengeodäsie der Technischen Universität München (FESG)	Germany
Observatório Astronómico Nacional - Yebeas	Instituto Geográfico Nacional	Spain
Radioastronomical Observatory Zelenchukskaya	Institute of Applied Astronomy RAS	Russia

### Operation Centers

Component Name	Sponsoring Organization	Country
Institut für Geodäsie und Geoinformation (IGGB)	Universität Bonn	Germany
CORE Operation Center	NASA Goddard Space Flight Center	USA
NEOS Operation Center	National Earth Orientation Service (NEOS)	USA

### Correlators

Component Name	Sponsoring Organization	Country
Astro/Geo Correlator at MPI	Bundesamt für Kartographie und Geodäsie, Institut für Geodäsie und Geoinformation der Universität Bonn, Max-Planck-Institut für Radioastronomie	Germany
MIT Haystack Correlator	NASA Goddard Space Flight Center	USA
Institute of Applied Astronomy Correlator	Institute of Applied Astronomy	Russia
National Institute of Information and Communications Technology (NICT)	National Institute of Information and Communications Technology (NICT)	Japan
Tsukuba VLBI Center	Geographical Survey Institute	Japan
Washington Correlator	National Earth Orientation Service (NEOS)	USA

### Data Centers

Component Name	Sponsoring Organization	Country
BKG, Leipzig	Bundesamt für Kartographie und Geodäsie	Germany
Crustal Dynamics Data Information System (CDDIS)	NASA Goddard Space Flight Center	USA
GeoDAF	Agenzia Spaziale Italiana (ASI)	Italy
Italy INAF	Istituto di Radioastronomia INAF	Italy
National Institute of Information and Communications Technology	National Institute of Information and Communications Technology	Japan
Observatoire de Paris	Observatoire de Paris	France

### Analysis Centers

Component Name	Sponsoring Organization	Country
Astronomical Institute of St.-Petersburg University	Astronomical Institute of St.-Petersburg University	Russia
Geoscience Australia	Geoscience Australia	Australia
Observatoire de Bordeaux	Observatoire de Bordeaux	France
Centro di Geodesia Spaziale (CGS)	Agenzia Spaziale Italiana	Italy
DGFI	Deutsches Geodätisches Forschungsinstitut	Germany
Forsvarets forskningsinstitutt (FFI)	Norwegian Defence Research Establishment	Norway
IGGB-BKG Analysis Center	Institut für Geodäsie und Geoinformation der Universität Bonn and Bundesamt für Kartographie und Geodäsie	Germany
Goddard Space Flight Center	NASA Goddard Space Flight Center	USA
Haystack Observatory	Haystack Observatory and NASA Goddard Space Flight Center	USA
Institute of Applied Astronomy Analysis Center	Institute of Applied Astronomy	Russia
Institute of Geodesy and Geophysics (IGG)	Institute of Geodesy and Geophysics (IGG) of the University of Technology, Vienna	Austria
Italy INAF	Istituto di Radioastronomia INAF	Italy
Jet Propulsion Laboratory	Jet Propulsion Laboratory	USA
Korea Astronomy and Space Science Institute	Korea Astronomy and Space Science Institute	Korea
Main Astronomical Observatory	Main Astronomical Observatory, National Academy of Sciences, Kiev	Ukraine

National Astronomical Observatory of Japan	National Astronomical Observatory of Japan	Japan
National Institute of Information and Communications Technology	National Institute of Information and Communications Technology	Japan
Observatoire de Paris	Observatoire de Paris	France
Onsala Space Observatory	Chalmers University of Technology	Sweden
Pulkovo Observatory	Pulkovo Observatory	Russia
Sternberg State Astronomical Institute	Lomonosov Moscow State University	Russia
Shanghai Observatory	Shanghai Observatory, Chinese Academy of Sciences	China
U. S. Naval Observatory Analysis Center	U. S. Naval Observatory	USA
U. S. Naval Observatory Analysis Center for Source Structure	U. S. Naval Observatory	USA

### Technology Development Centers

Component Name	Sponsoring Organization	Country
Canadian VLBI Technology Development Center	NRCan, DRAO, CSA	Canada
Forsvarets forskningsinstitutt (FFI)	Norwegian Defence Research Establishment	Norway
Goddard Space Flight Center	NASA Goddard Space Flight Center	USA
Haystack Observatory	Haystack Observatory and NASA Goddard Space Flight Center	USA
Institute of Applied Astronomy Technology Development Center	Institute of Applied Astronomy	Russia
National Institute of Information and Communications Technology	National Institute of Information and Communications Technology	Japan
Onsala Space Observatory	Chalmers University of Technology	Sweden

## Addresses of Institutions of Authors Contributing to this Report

(listed alphabetically by country)

### Geoscience Australia

PO Box 378  
Canberra ACT  
2601  
Australia  
<http://ga.gov.au>

### University of Tasmania

School of Mathematics and Physics  
University of Tasmania  
Private Bag 37  
Hobart 7001  
Australia  
<http://www.phys.utas.edu.au/physics>

### Institute of Geodesy and Geophysics/University of Technology, Vienna

Gusshausstrasse 27-29  
1040 Vienna  
Austria  
<http://www.hg.tuwien.ac.at>

### CRAAM, Universidade Presbiteriana Mackenzie, São Paulo

CRAAM  
Instituto Presbiteriano Mackenzie  
Rua da Consolação 896  
01302-907 São Paulo  
SP  
Brazil  
<http://www.craam.mackenzie.br>

### Instituto Nacional de Pesquisas Espaciais

Estrada do Fio 6000  
Bairro Tupuiú  
61760-000 Eusébio  
CE  
Brazil  
<http://www.roen.inpe.br>

### Geodetic Survey Division, Natural Resources Canada

615 Booth St.  
Ottawa  
Ontario  
Canada K1A 0E9  
<http://www.geod.nrcan.gc.ca>



## Bundesamt für Kartographie und Geodäsie - TIGO

Casilla 4036  
Correo 3  
Concepción  
Chile  
<http://www.fs.wetzell.de>

## Universidad de Concepción - TIGO

Concepción  
Chile  
<http://www.udec.cl>

## Shanghai Astronomical Observatory, CAS

80 Nandan Road  
Shanghai 200030  
China  
<http://www.shao.ac.cn/>

## Urumqi Observatory, NAO-CAS

40-5 South Beijing Road  
Urumqi  
Xinjiang Uygur Autonomous Region  
830011  
China  
<http://www.uao.ac.cn>

## Observatoire de Bordeaux

2 rue de l'Observatoire  
BP 89  
33271 Floirac Cedex  
France  
<http://www.obs.u-bordeaux1.fr>

## Observatoire de Paris, SYRTE, CNRS/UMR8630

61 avenue de l'Observatoire  
75014 Paris  
France  
<http://www.obspm.fr>  
<http://ivsopar.obspm.fr>

## Bundesamt für Kartographie und Geodäsie

Richard-Strauss-Allee 11  
60598 Frankfurt am Main  
Germany  
<http://www.bkg.bund.de>

## Deutsches Geodätisches Forschungsinstitut (DGFI)

Alfons-Goppel-Strasse 11  
80539 München  
Germany  
<http://www.dgfi.badw.de>

Fundamentalstation Wettzell

Bundesamt für Kartographie und Geodäsie (BKG) and  
Forschungseinrichtung Satellitengeodäsie (FESG)  
Sackenrieder Str. 25.  
D-93444 Kötzing  
Germany  
<http://www.fs.wettzell.de>

Institut für Geodäsie und Geoinformation der Universität Bonn

Nussallee 17  
53115 Bonn  
Germany  
<http://vlbi.geod.uni-bonn.de>

Max-Planck-Institute for Radioastronomy

Auf dem Hügel 69  
53121 Bonn  
Germany  
<http://www.mpifr-bonn.mpg.de>

Agenzia Spaziale Italiana

Centro di Geodesia Spaziale (CGS)  
Contrada Terlecchia  
75100 Matera  
Italy  
<http://www.asi.it/>

Istituto di Radioastronomia, Bologna

Via P. Gobetti 101  
40129 Bologna  
Italy  
<http://www.ira.inaf.it>

Istituto di Radioastronomia, Medicina

C.P. 14  
40060 Villafontana  
Bologna  
Italy  
<http://www.med.ira.inaf.it>

Istituto di Radioastronomia INAF, Stazione VLBI di Noto

C.P. 161  
I-96017 Noto SR  
Italy  
<http://www.noto.ira.inaf.it>

Geographical Survey Institute, Japan  
Kitasato 1  
Tsukuba  
Ibaraki  
Japan  
<http://vldb.gsi.go.jp/sokuchi/vlbi/en/>

Mizusawa VERA Observatory, NAOJ  
2-12 Hoshigaoka-cho  
Mizusawa-ku  
Oshu City  
Iwate Prefecture 023-0861  
Japan  
<http://www.miz.nao.ac.jp>

National Institute of Information and Communications Technology  
893-1 Hirai  
Kashima  
Ibaraki 314-08501  
Japan  
[http://www2.nict.go.jp/w/w114/stsi/index\\_e.html](http://www2.nict.go.jp/w/w114/stsi/index_e.html)

National Institute of Polar Research  
1-9-10  
Kaga  
Itabashi-ku  
Tokyo 173-8515  
Japan  
<http://www.nipr.ac.jp>

Ajou University  
442-743  
Rep. of Korea  
<http://www.ajou.ac.kr>

Korea Astronomy and Space Science Institute  
305-348  
Rep. of Korea  
<http://www.kasi.re.kr>

Institute for Radiophysics and Space Research, Auckland University of Technology  
Private Bag 92006  
Auckland 1142  
New Zealand  
<http://www.crsr.ac.nz>

Forsvarets forskningsinstitutt (FFI) (Norwegian Defence Research Establishment)

FFI/E  
Box 25  
2007 Kjeller  
Norway  
<http://www.ffi.no/>

Geodetic Institute, Norwegian Mapping Cadastre Authority

Kartverksveien  
Hønefoss  
Norway  
<http://www.statkart.no>

Central Astronomical Observatory at Pulkovo of Russian Academy of Sciences

Pulkovskoe Ch. 65/1  
St. Petersburg  
196140  
Russia  
<http://www.gao.spb.ru/english>

Institute of Applied Astronomy of Russian Academy of Sciences

nab. Kutuzova 10  
St. Petersburg  
191187  
Russia  
<http://www.ipa.nw.ru>

Sobolev Astronomical Institute of Saint Petersburg University

Universitetskii pr. 28  
Starii Peterhof  
Saint Petersburg  
198504  
Russia  
<http://www.astro.spbu.ru>

HartRAO, NRF

PO Box 443  
Krugersdorp  
1740  
South Africa  
<http://www.hartrao.ac.za>

Instituto Geográfico Nacional

Calle General Ibañez de Ibero 3  
E-28003 Madrid  
Spain  
<http://www.ign.es/>

Observatório Astronómico Nacional  
Apartado 112  
E-28803 Alcalá de Henares  
Spain  
<http://www.oan.es/>

Onsala Space Observatory (OSO)  
SE-439 92  
Onsala  
Sweden  
<http://www.oso.chalmers.se>

Main Astronomical Observatory, National Academy of Sciences of Ukraine  
Main Astronomical Observatory  
27 Akademika Zabolotnoho St.  
Kiev  
03680  
Ukraine  
<http://www.mao.kiev.ua>

Radio Astronomy Lab of Crimean Astrophysical Observatory  
RT-22  
Katsively  
Yalta Crimea 98688  
Ukraine  
<http://www.crao.crimea.ua>

Jet Propulsion Laboratory, California Institute of Technology  
Mail Stop 238-600  
4800 Oak Grove Dr.  
Pasadena, CA 91109  
USA  
<http://www.jpl.nasa.gov>

Kokee Park Geophysical Observatory  
Kokee State Park  
P.O. Box 538  
Waimea, Hawaii 96796  
USA

MIT Haystack Observatory  
Off Route 40  
Westford, MA 01886  
USA  
<http://www.haystack.mit.edu/>

NASA Goddard Space Flight Center

Code 698

Greenbelt, MD 20771

USA

<http://www.nasa.gov>

<http://vlbi.gsfc.nasa.gov>

U.S. Naval Observatory

3450 Massachusetts Ave. NW

Washington, DC 20392

USA

<http://www.usno.navy.mil>

U.S. Naval Observatory, Flagstaff Station

10391 West Naval Observatory Rd.

Flagstaff, AZ 86001

USA

<http://www.nofs.navy.mil>

---

## List of Acronyms

AAS	American Astronomical Society
AC	(IVS) Analysis Center
ACF	AutoCorrelation Function
ACU	Antenna Control Unit
ADC	Analog to Digital Converter
AES	Advanced Engineering Services Co., Ltd (Japan)
AGILE	Astro-rivelatore Gamma ad Immagini LEggero satellite (Italy)
AGN	Active Galactic Nuclei
AIPS	Astronomical Image Processing System
AIUB	Astronomical Institute, University of Bern (Switzerland)
AO	Astronomical Object
APSG	Asia-Pacific Space Geodynamics program
APT	Asia Pacific Telescope
ARIES	Astronomical Radio Interferometric Earth Surveying program
ASD	Allan Standard Deviation
ASI	Agenzia Spaziale Italiana (Italy)
ATA	Allen Telescope Array (USA)
ATCA	Australia Telescope Compact Array (Australia)
ATM	Asynchronous Transfer Mode
ATNF	Australia Telescope National Facility (Australia)
AUT	Auckland University of Technology (New Zealand)
A-WVR	Advanced Water Vapor Radiometer
BBC	Base Band Converter
BdRAO	Badary Radio Astronomical Observatory (Russia)
BIPM	Bureau International de Poids et Mesures (France)
BKG	Bundesamt für Kartographie und Geodäsie (Germany)
BMC	Basic Module of Correlator
BOSSNET	BOSon South NETwork
BVID	Bordeaux VLBI Image Database
BWG	Beam WaveGuide
CARAVAN	Compact Antenna of Radio Astronomy for VLBI Adapted Network (Japan)
CAS	Chinese Academy of Sciences (China)
CASPER	Center for Astronomy Signal Processing and Electronics Research (USA)
CAY	Centro Astronómico de Yebes (Spain)
CC	(IVS) Coordinating Center
CDDIS	Crustal Dynamics Data Information System (USA)
CDP	Crustal Dynamics Project
CE	Conformité Européene
CE-1	Chang'E-1 (China)
CGS	Centro di Geodesia Spaziale (Italy)
CIB	Correlator Interface Board
CIP	Celestial Intermediate Pole

CLARA	Cooperación Latino Americana de Redes Avanzadas
CMB	Core-Mantle Boundary
CMONC	Crustal Movement Observation Network of China (China)
CNES	Centre National d'Etudes Spatiales (France)
CNIG	Centro Nacional de Información Geográfica (Spain)
CNRS	Centre National de la Recherche Scientifique (France)
CNS	Communication, Navigation and Surveillance systems, Inc. (USA)
CODA	Correlator Output Data Analyzer
CORE	Continuous Observations of the Rotation of the Earth
CORS	Continuously Operating Reference Stations
CRAAE	Centro de Rádio Astronomia e Aplicações Espaciais (Brazil)
CRAAM	Centro de Rádio Astronomia e Astrofísica Mackenzie (Brazil)
CrAO	Crimean Astrophysical Observatory (Ukraine)
CRESTech	Centre for Research in Earth and Space Technology (Canada)
CRF	Celestial Reference Frame
CRL	Communications Research Laboratory (now NICT) (Japan)
CSA	Canadian Space Agency (Canada)
C-SART	Constrained Simultaneous Algebraic Reconstruction Technique
CSIR	Council for Scientific and Industrial Research (South Africa)
CSRIFS	Combined Square Root Information Filter and Smoother
CSTnet	China Science and Technology Network (China)
CVN	Chinese VLBI Network
DAR	Data Acquisition Rack
DAS	Data Acquisition System
DBBC	Digital Base Band Converter
DBE	Digital BackEnd
$\Delta$ DOR	Delta Differenced One-way Range
DGFI	Deutsches Geodätisches Forschungsinstitut (Germany)
DLR	Deutsches Zentrum für Luft- und Raumfahrt (German Aerospace Center)
DOM	Data Output Module
DORIS	Doppler Orbitography and Radiopositioning Integrated by Satellite
DR	Dichroic Reflector
DRAGON	Dynamic Resource Allocation through GMPLS over Optical Networks
DRAO	Dominion Radio Astrophysical Observatory (Canada)
DSN	Deep Space Network
DSP	Digital Signal Processor
DSS	Deep Space Station
ECMWF	European Centre for Medium-Range Weather Forecasts
EDM	Electronic Distance Measurement
EFTF	European Frequency and Time Forum
EGU	European Geosciences Union
ENVISAT	ENVironmental SATellite
EOP	Earth Orientation Parameters
EOS	Earth Observing System
EOT8A	Empirical Ocean Tide 2008 model from multi-mission satellite Altimetry



---

ERP	Earth Rotation Parameters
ETS-Lindgren	EMC Test Systems-Lindgren (USA)
EUREF	EUropean REference Frame
EVGA	European VLBI for Geodesy and Astrometry
EVLA	Expanded Very Large Array
e-VLBI	Electronic VLBI
EVN	European VLBI Network
EXPreS	Express Production Real-time e-VLBI Service
FAGS	Federation of Astronomical and Geophysical data analysis Services
FCN	Free Core Nutation
FEM	Finite Element Modeling
FESG	Forschungseinrichtung Satellitengeodäsie/Technical University of Munich (Germany)
FFI	Forsvarets ForskningsInstitutt (Norwegian Defence Research Establishment) (Norway)
FICN	Free Inner Core Nutation
FILA	FIRst LAst
FITS	Flexible Image Transport System
FPDP	Front Panel Data Port
FS	Field System
FSL	Field System Linux
FTP	File Transfer Protocol
FWF	Fonds zur Förderung der wissenschaftlichen Forschung (Austrian Science Fund)
GA	Geoscience Australia (Australia)
GAPE	Great Alaska and Pacific Experiment
GARNET	GSI Advanced Radiotelescope NETwork (Japan)
GARS	German Antarctic Receiving Station (Germany)
GASP	GLAST-AGILE Support Program
GEMD	Geospatial and Earth Monitoring Division (Australia)
GeoDAF	Geodetic Data Archiving Facility (Italy)
GEX	Giga-bit series VLBI EXperiment
GFZ	GeoForschungsZentrum (Germany)
GGAO	Goddard Geophysical and Astronomical Observatory (USA)
GGFC	Global Geophysical Fluids Center
GGOS	Global Geodetic Observing System
GGP	Global Geodynamics Project
GINS	Géodésie par Intégrations Numériques Simultanées
GISTM	GPS Ionospheric Scintillation and TEC Monitor
GLAST	Gamma ray Large Area Space Telescope (USA)
GLONASS	GLOBAL NAVIGATION Satellite System (Russia)
GLORIA	GLOBAL Radio Interferometry Analysis
GMPLS	Generalized MultiProtocol Label Switching
GNS Science	Geological and Nuclear Sciences Research Institute (New Zealand)
GNSS	Global Navigation Satellite Systems
GOT	Goddard/Grenoble Ocean Tide

GPS	Global Positioning System
GPT	Global Pressure and Temperature
GREF	German GPS REFERENCE network
GRGS	Groupe de Recherches de Géodésie Spatiale (France)
GSD	Geodetic Survey Division of Natural Resources Canada (Canada)
GSFC	Goddard Space Flight Center (USA)
GSI	Geographical Survey Institute (Japan)
GSS	Generator of Synchronization Signals
HartRAO	Hartebeesthoek Radio Astronomy Observatory (South Africa)
HEMT	High Electron Mobility Transistor
HPBW	Half Power Beam Width
HTS	High Temperature Superconductor
HTSI	Honeywell Technology Solutions Incorporated (USA)
IAA	Institute of Applied Astronomy (Russia)
IAG	International Association of Geodesy
IAU	International Astronomical Union
ICRF	International Celestial Reference Frame
IERS	International Earth Rotation and Reference Systems Service
IF	Intermediate Frequency
IGFN	Italian Space Agency GPS Fiducial Network (Italy)
IGG	Institute of Geodesy and Geophysics (Austria)
IGGB	Institut für Geodäsie und Geoinformation der Universität Bonn (Germany)
IGM	Instituto Geográfico Militar (Chile)
IGN	Instituto Geográfico Nacional (Spain)
IGS	International GNSS Service
ILRS	International Laser Ranging Service
IMC	Interface Module of Correlator
INAF	Istituto Nazionale di Astrofisica (Italy)
INGV	Institute of Geophysics and Volcanology (Italy)
INPE	Instituto Nacional de Pesquisas Espaciais (Brazil)
InSAR	Interferometric Synthetic Aperture Radar
IP	Internet Protocol
IRA	Istituto di RadioAstronomia (Italy)
IRAS	InfraRed Astronomy Satellite
IRSR	Institute for Radiophysics and Space Research (New Zealand)
ISBN	International Standard Book Number
ITRF	International Terrestrial Reference Frame
ITRS	International Terrestrial Reference System
IUGG	International Union of Geodesy and Geophysics
IVOA	International Virtual Observatory Alliance
IVS	International VLBI Service for Geodesy and Astrometry
JADE	Japanese Dynamic Earth observation by VLBI
JARE	Japanese Antarctic Research Expedition (Japan)
JAXA	Japan Aerospace Exploration Agency (Japan)
JGN	Japan Gigabit Network (Japan)

---

JHB	JoHannesBurg
JIVE	Joint Institute for VLBI in Europe
JLRA	Joint Laboratory for Radio Astronomy (China)
JMA	Japan Meteorological Agency (Japan)
JPL	Jet Propulsion Laboratory (USA)
JST	Japan Standard Time
KARAT	KAshima RAY-tracing Tools (Japan)
KARATS	KAshima RAY-Tracing Service (Japan)
KAREN	Kiwi Advanced Research and Education Network (New Zealand)
KASI	Korea Astronomy and Space Science Institute (Korea)
KPGO	Koike Park Geophysical Observatory (USA)
KSP	KeyStone Project (Japan)
KSRC	Kashima Space Research Center (Japan)
KVN	Korean VLBI Network
LBA	Long Baseline Array (Australia)
LCS	Long baseline array Calibrator Survey
LED	Light-Emitting Diode
LEO	Low Earth Orbit
LLR	Lunar Laser Ranging
LNA	Low Noise Amplifier
LO	Local Oscillator
LOD	Length Of Day
LRS	Laser Ranging System
LSB	Lower Side Band
LSC	Least Squares Collocation
LSM	Least Squares Method
MAO	Main Astronomical Observatory (Ukraine)
MARBLE	Multiple Antenna Radio-interferometry for Baseline Length Evaluation
MIT	Massachusetts Institute of Technology (USA)
MITEQ	Microwave Information Transmission Equipment (USA)
MJD	Modified Julian Date
MLRO	Matera Laser Ranging Observatory (Italy)
MOBLAS	MOBile LASer
MODEST	MODEl and ESTimate
MPI	Max-Planck-Institute (Germany)
MPIfR	Max-Planck-Institute for Radioastronomy (Germany)
MTLRS	Modular Transportable Laser Ranging System
NAO	National Astronomical Observatories (China)
NAOJ	National Astronomical Observatory of Japan (Japan)
NASA	National Aeronautics and Space Administration (USA)
NCRIS	National Collaborative Research Infrastructure Strategy (Australia)
NEOS	National Earth Orientation Service (USA)
NetCDF	Network Common Data Form
NGS	National Geodetic Survey (USA)
NICT	National Institute of Information and Communications Technology (Japan)

NIPR	National Institute of Polar Research (Japan)
NMA	Norwegian Mapping Authority (Norway)
NMF	Niell Mapping Function
NNR	No-Net-Rotation
NNT	No-Net-Translation
NOAA	National Oceanic and Atmospheric Administration (USA)
NOFS	U.S. Naval Observatory Flagstaff Station (USA)
NRAO	National Radio Astronomy Observatory (USA)
NRCan	Natural Resources Canada (Canada)
NSF	National Science Foundation (USA)
NTT	Nippon Telegraph and Telephone Corporation (Japan)
NVI	NVI, Inc. (USA)
OAM	Observatorio Astronómico de Madrid (Spain)
OAN	Observatorio Astronómico Nacional (Spain)
OCA	Observatoire de la Côte d'Azur (France)
OPAR	Observatoire de Paris (France)
OPC	(IVS) Observing Program Committee
ORCA	Optical ReCeiver/splitter/Amplifier
OS	Operating System
OSO	Onsala Space Observatory (Sweden)
PARNASSUS	Processing Application in Reference to NICT's Advanced Set of Softwares Usable for Synchronization
PASJ	Publications of the Astronomical Society of Japan
PCAL	Phase CALibration
PFB	Polyphase Filter Bank
PLO	Phase Locked Oscillator
PM	Polar Motion
POLARIS	POlAr motion Analysis by Radio Interferometric Surveying
PPN	Parameterized Post-Newtonian
PPP	Precise Point Positioning
PRAO	Pushchino Radio Astronomy Observatory (Russia)
QRHA	Quad-Ridge Horn Antenna
QZSS	Quasi Zenith Satellite System (Japan)
RAS	Russian Academy of Sciences (Russia)
RDV	Research and Development sessions using the VLBA
REUNA	Red Universitaria Nacional (Chile)
RFCN	Retrograde Free Core Nutation
RFI	Radio Frequency Interference
ROACH	Reconfigurable Open Architecture Computing Hardware
ROEN	Rádio-Observatório Espacial do Nordeste (Brazil)
RRFID	Radio Reference Frame Image Database
RS-232C	Recommended Standard-232C
RTNF	Radio Telescope National Facility (New Zealand)
SATA	Serial Advanced Technology Attachment
SDK	Software Development Kit

---

SDM	Signal Distribution Modules
SDSS	Signal Distribution and Synchronization System
SEFD	System Equivalent Flux Density
SGT	Stinger Ghaffarian Technologies (USA)
SHAO	SHanghai Astronomical Observatory (China)
SI	Structure Index
SINEX	Solution INdependent EXchange format
SLR	Satellite Laser Ranging
SOSW	Satellite Observing System Wettzell (Germany)
SPbU	Saint-Petersburg University (Russia)
SPEED	Short Period and Episodic Earth rotation Determination
SPU	Saint-Petersburg University (Russia)
SRIF	Square Root Information Filter
SRT	Sardinia Radio Telescope (Italy)
SRTM	Shuttle Radar Topography Mission
SSA	Singular Spectrum Analysis
STEREO	Solar TERrestrial RELations Observatory
SvRAO	Svetloe Radio Astronomical Observatory (Russia)
SWT	SW Technology (USA)
TAC	Totally Accurate Clock
TANAMI	Tracking Active galactic Nuclei with Australia Milliarcsecond Interferometry (Australia)
TAO	Telecommunications Advanced Organization (Japan)
TDC	(IVS) Technology Development Center
TEC	Total Electron Content
TEMPO	Time and Earth Motion Precision Observations
TENET	Tertiary Education and Research Network of South Africa (South Africa)
TERENA	Trans-European Research and Education Networking Association
TerraSAR-X	Terra Synthetic Aperture Radars X-band (Germany)
TIGO	Transportable Integrated Geodetic Observatory (Germany, Chile)
TLRS	Transportable Laser Ranging System
TRF	Terrestrial Reference Frame
TUM	Technical University of Munich (Germany)
TWSTFT	Two-Way Satellite Time and Frequency Transfer
UC Berkeley	University of California, Berkeley (USA)
UD	Upper Diagonal
UDC	Up-Down Converter
URSI	Union Radio-Scientifique Internationale
USB	Upper Side Band
USNO	United States Naval Observatory (USA)
UT	Universal Time
UT1	Universal Time
UTAS	University of TASmania (Australia)
UTC	Coordinated Universal Time
UV	UltraViolet

VC	Video Converter
VDBE	VLBA Digital BackEnd
VDIF	VLBI Data Interchange Format
VERA	VLBI Exploration of Radio Astrometry
VEX	VLBI EXchange format
VieVS	Vienna VLBI Software
VLA	Very Large Array (USA)
VLBA	Very Long Baseline Array (USA)
VLBI	Very Long Baseline Interferometry
VMF	Vienna Mapping Functions
VO	Virtual Observatory
VSI	VLBI Standard Interface
VSI-H	VLBI Standard Interface Hardware
VSOP	VLBI Space Observatory Program
VSSP	Versatile Scientific Sampling Processor
VTRF	VLBI Terrestrial Reference Frame
WACO	WAshington COrrrelator (USA)
WEBT	Whole Earth Blazar Telescope
WG	Working Group
WGS84	World Geodetic System 1984
WMAP	Wilkinson Microwave Anisotropy Probe
WVR	Water Vapor Radiometer
WWW	World Wide Web
ZcRAO	Zelenchukskaya Radio Astronomical Observatory (Russia)
ZTD	Zenith Total Delay
ZWD	Zenith Wet Delay









REPORT DOCUMENTATION PAGE				Form Approved OMB No. 0704-0188	
<p>The public reporting burden for this collection of information is estimated to average 1 hour per response, including the time for reviewing instructions, searching existing data sources, gathering and maintaining the data needed, and completing and reviewing the collection of information. Send comments regarding this burden estimate or any other aspect of this collection of information, including suggestions for reducing this burden, to Department of Defense, Washington Headquarters Services, Directorate for Information Operations and Reports (0704-0188), 1215 Jefferson Davis Highway, Suite 1204, Arlington, VA 22202-4302. Respondents should be aware that notwithstanding any other provision of law, no person shall be subject to any penalty for failing to comply with a collection of information if it does not display a currently valid OMB control number.</p> <p><b>PLEASE DO NOT RETURN YOUR FORM TO THE ABOVE ADDRESS.</b></p>					
1. REPORT DATE (DD-MM-YYYY) 15-08-2009		2. REPORT TYPE Technical Publication		3. DATES COVERED (From - To)	
4. TITLE AND SUBTITLE International VLBI Service for Geodesy and Astrometry 2008 Annual Report				5a. CONTRACT NUMBER	
				5b. GRANT NUMBER	
				5c. PROGRAM ELEMENT NUMBER	
6. AUTHOR(S) Dirk Behrend, Karen D. Baver				5d. PROJECT NUMBER	
				5e. TASK NUMBER	
				5f. WORK UNIT NUMBER	
7. PERFORMING ORGANIZATION NAME(S) AND ADDRESS(ES) Goddard Space Flight Center Greenbelt, MD 20771				8. PERFORMING ORGANIZATION REPORT NUMBER 200902253	
9. SPONSORING/MONITORING AGENCY NAME(S) AND ADDRESS(ES) National Aeronautics and Space Administration Washington, DC 20546-0001				10. SPONSORING/MONITOR'S ACRONYM(S)	
				11. SPONSORING/MONITORING REPORT NUMBER NASA/TP-2009-214183	
12. DISTRIBUTION/AVAILABILITY STATEMENT Unclassified-Unlimited, Subject Category: 46 Report available from the NASA Center for Aerospace Information, 7115 Standard Drive, Hanover, MD 21076. (443)757-5802					
13. SUPPLEMENTARY NOTES Dirk Behrend, NVI, Inc., Greenbelt, MD; Karen Baver, NVI, Inc., Greenbelt, MD					
14. ABSTRACT This volume of reports is the 2008 Annual Report of the International VLBI Service for Geodesy and Astrometry (IVS). The individual reports were contributed by VLBI groups in the international geodetic and astrometric community who constitute the components of IVS. The 2008 Annual Report documents the work of these IVS components over the period January 1, 2008 through December 31, 2008. The reports document changes, activities, and progress of the IVS. The entire contents of this Annual Report also appear on the IVS Web site at <a href="http://ivsec.gsfc.nasa.gov/publications/ar2008">http://ivsec.gsfc.nasa.gov/publications/ar2008</a> .					
15. SUBJECT TERMS Geodesy, astrometry, VLBI, geophysics, Earth orientation, very long baseline interferometry, interferometry, radio astronomy, geodynamics, reference frames, terrestrial reference frame, celestial reference frame, length of day, Earth system science, Earth rotation.					
16. SECURITY CLASSIFICATION OF:			17. LIMITATION OF ABSTRACT	18. NUMBER OF PAGES	19b. NAME OF RESPONSIBLE PERSON
a. REPORT	b. ABSTRACT	c. THIS PAGE			Dirk Behrend
Unclassified	Unclassified	Unclassified	Unclassified	396	19b. TELEPHONE NUMBER (Include area code) (301) 614-5939

Back cover: The Intensive data are either physically shipped on hard disks or e-transferred over the Internet from the stations to the correlators. The Int1 sessions are correlated at the U.S. Naval Observatory (USNO), the Int2 sessions at the Geographical Survey Institute (GSI) in Japan, and the Int3 sessions at the Bonn (Germany) correlator hosted at the Max Planck Institute for Radio Astronomy.

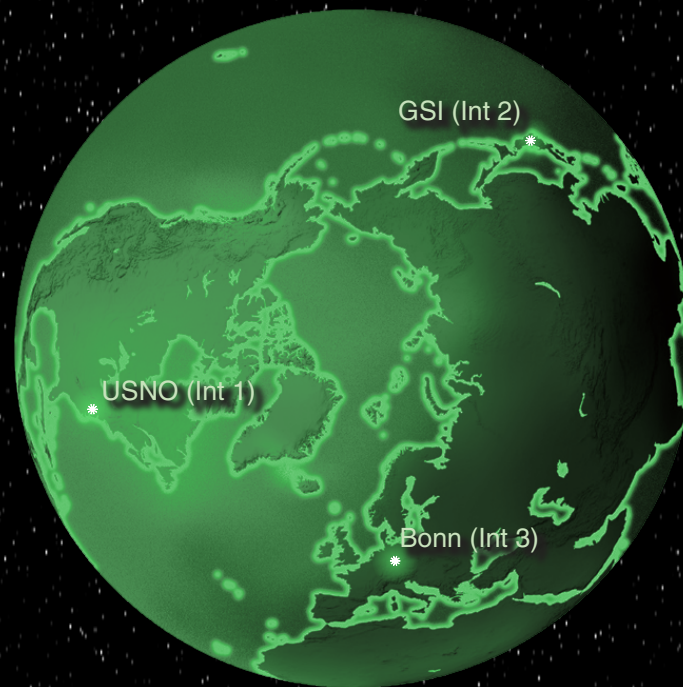

International VLBI Service for Geodesy and Astrometry

IVS Coordinating Center  
NASA Goddard Space Flight Center  
Code 698  
Greenbelt, MD 20771

<http://ivscg.gsfc.nasa.gov>  
[ivscg@ivscg.gsfc.nasa.gov](mailto:ivscg@ivscg.gsfc.nasa.gov)  
phone: 301-614-5939  
fax: 301-614-6522